



# Apollo 11

## Flight Plan

Final – July 1, 1969

**NATIONAL AERONAUTICS AND SPACE ADMINISTRATION**



**MANNED SPACECRAFT CENTER  
HOUSTON, TEXAS**



APOLLO 11 - FLIGHT PLAN

315 pages



NATIONAL AERONAUTICS AND SPACE ADMINISTRATION

FINAL

# APOLLO 11 FLIGHT PLAN

AS-506/CSM-107/LM-5

JULY 1, 1969

PREPARED BY  
FLIGHT PLANNING BRANCH  
FLIGHT CREW SUPPORT DIVISION

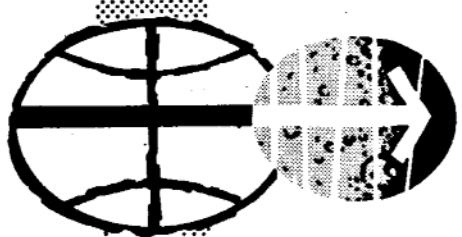

MANNED SPACECRAFT CENTER  
HOUSTON, TEXAS

INDEXING DATA

DATE	OFF	#	T	DDM	SUBJECT	SIGNATOR	LOC
7-1-69	101		1		AS-506		

SECTION I

SECTION II

SECTION III

SECTION IV

SECTION V

SECTION VI

NATIONAL AERONAUTICS AND SPACE ADMINISTRATION

**Apollo 11  
Flight Plan  
Final – July 1, 1969**

MANNED SPACECRAFT CENTER

HOUSTON, TEXAS



APOLLO 11  
APOLLO AS-506/CSM-107/LM-5  
FINAL FLIGHT PLAN

JULY 1, 1969

Submitted by:

  
L. J. Riché  
Flight Planning Branch

  
G. M. Colton  
Flight Planning Branch

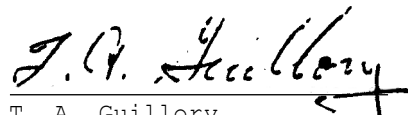
  
T. A. Guillory  
Flight Planning Branch

Approved by:

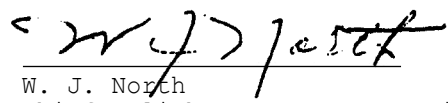
  
W. J. North  
Chief, Flight Crew Support Division

  
Donald K. Slayton  
Director of Flight Crew Operations

Concurrence:

  
George M. Low  
Manager, Apollo Spacecraft Program

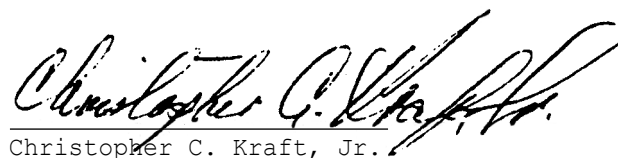
  
Christopher C. Kraft, Jr.  
Director of Flight Operations

Any comments or questions on this document should be forwarded to T. A. Guillory, Flight Planning Branch, mail code CF34, extension 4271.





#### ACKNOWLEDGMENT

Acknowledgment is made to Messrs. Richard Rogers, William Killian and Spencer Gardner for their technical support in the preparation of the Apollo 11 Flight Plan.

Views of the earth and the P52 stars shown in the Flight Plan were taken from the document, "Views from the CM and LM During the Flight of Apollo 11" (Mission G).

The CSM and LM attitude information was taken from the document, "Lunar Orbit Attitude Sequence for Mission G".



## TABLE OF CONTENTS

Abbreviations	iii
Introduction	x

### SECTION I - GENERAL

1. Mission Description	1-1
2. Summary Flight Plan (TLC-TEC)	1-5
3. Summary Flight Plan (Lunar Orbit)	1-6
4. LM Power Descent Profile	1-7
5. CSM Burn Schedule	1-8
6. LM Burn Schedule	1-9
7. Lunar Landing Site Data	1-10
8. Landmark Tracking Data	1-10
9. Flight Plan Notes	1-13

### SECTION II - UPDATE FORMS

1. Update Forms Table	2-1
2. CSM Maneuver Update Pads	2-2
3. LM Maneuver Update Pads	2-27

### SECTION III - DETAILED TIMELINE

1. Launch Phase	3-1
2. TLI-T&D	3-3, 3-4
3. Translunar Coast Activities	
a. Cislunar Navigation	3-7, 3-17
b. LM Familiarization	3-35
c. Lunar Orbit Insertion	3-47
4. Lunar Orbit Activities	
a. Second LM Ingress	3-53
b. LM Activation and C/O	3-63

SECTION III CONT'D

c. Undocking	3-67
d. Touchdown	3-69
e. EVA	3-77
f. LM Liftoff	3-90
g. LM Active Docking	3-94
h. LM Jettison	3-97
5. TEI-TEC	3-101
6. Entry	3-135

SECTION IV DETAILED TEST OBJECTIVES

1. Detailed Test Objectives	4-1
2. Test Objective/Mission Activity Cross Reference	4-2
3. Test Objectives	4-6

SECTION V - CONSUMABLES

1. RCS Propellant Usage	5-2
2. SM RCS Budget	5-3
3. CM RCS Budget	5-22
4. SPS Budget	5-23
5. LM RCS Budget	5-25
6. DPS Budget	5-31
7. APS Budget	5-32
8. CSM EPS Budget	5-36
9. LM EPS Budget	5-41
10. LM ECS Budget	5-45
11. PLSS Budget	5-50

SECTION VI - SUMMARY FLIGHT PLAN

Summary Flight Plan	6-1
---------------------	-----

## ABBREVIATIONS

ACCEL	Accelerometer
ACN	Ascension
ACT	Activation
ACQ	Acquisition
AEA	Abort Electronics Assembly
AGS	Abort Guidance Subsystem
AH	Ampere Hours
ALSCC	Apollo Lunar Surface Close-up Camera
ALT	Altitude
AMP or amp	Ampere
ANG	Antigua
ANT	Antenna
AOH	Apollo Operations Handbook
AOS	Acquisition of Signal or Acquisition of Site
AOT	Alignment Optical Telescope
APS	Ascent Propulsion Subsystem
ARS	Atmosphere Revitalization System
ATT	Attitude
AUX	Auxiliary
AZ	Azimuth
BAT	Battery
BDA	Bermuda
Bio	Bio-Medical Data on Voice Downlink
BP	Barber Pole
BT	Burn Time
BU	Backup
BW	Black & White
BRKT	Bracket
CAP COM	Capsule Communicator
CAL	Calibration Angle
CAM	Camera
CB	Circuit Breaker
CDH	Constant Delta Altitude
CDR	Commander
CDU	Coupling Data Unit
CEX	Color External
CIN	Color Internal
CIRC	Circularization
CK	Check
CM	Command Module
CMC	Command Module Computer
CMD	Command
CMP	Command Module Pilot
CNTL	Control
C/O	Check out
COAS	Crew Optical Alignment Sight
COMM	Communications
CONFIG	Configuration
CONT	Continue
CP	Control Point
CRO	Carnarvon, Australia
CRYO	Cryogenic
CSC	Contingency Sample Collection
CSI	Coelliptic Sequence Initiation
CSM	Command Service Module
C&WS	Caution and Warning System
CYI	Grand Canary Island
DAP	Digital Auto Pilot
DB	Deadband
DCA	Digital Command Assembly
DEDA	Data Entry and Display Assembly
DEGS	Degrees
DEPL	Depletion
DET	Digital Event Timer
DIFF	Difference

DOI	Descent Orbit Insertion
DPS	Descent Propulsion System
DS	Documented Sample
DSE	Data Storage Equipment
DSKY	Display and Keyboard
DTO	Detailed Test Objective
DUA	Digital Uplink Assembly
DWN	Down
E	Erasable or Enter
EASEP	Early Apollo Scientific Experiment Package
ECS	Environmental Control System
ED	Explosive Device
EDT	Eastern Daylight Time
EFH	Earth Far Horizon
EI	Earth (atmosphere) Interface
EL	Elevation or Electric
EMS	Entry Monitor System
EMU	Extravehicular Mobility Unit
ENH	Earth Near Horizon
EPO	Earth Parking Orbit
EPS	Electrical Power Subsystem
EQUIP	Equipment
EST	Eastern Standard Time
EVA	Extravehicular Activity
EVAP	Evaporator
EVT	Extravehicular Transfer
EXT	External
f	F Stop
FC	Fuel Cell
FDAI	Flight Director Attitude Indicator
FLT	Flight
FM	Frequency Modulated
FOV	Field of View
fps or FPS	Feet per second
FT or ft	Feet
FTO	Flight Test Objective
FTP	Full Throttle Position
GBI	Grand Bahama Islands
GBM	Grand Bahama (MSFN)
GDC	Gyro Display Coupler
GDS	Goldstone, California
GET	Ground Elapsed Time
GETI	Ground Elapsed Time of Ignition
GLY	Glycol
GMT	Greenwich Mean Time
G&N	Guidance and Navigation
GNCS	Guidance Navigation Control System
GWM	Guam
GYM	Guaymas, Mexico
H2	Hydrogen
HA	Apogee Altitude
HAW	Hawaii
HBR	High Bit Rate (TLM)
HD	Highly Desirable
HGA	High Gain Antenna
HI	High
Hp	Perigee Altitude
HSK	Honeysuckle (Canberra, Australia)
HTR	Heater
HTV	USNS Huntsville
ICDU	Inertial Coupling Data Unit
ID	Identification
IGA	Inner Gimbal Angle
IGN	Ignition
IMU	Inertial Measurement Unit

INIT	Initialization
INT	Intervalometer
IP	Initial Point
ISA	Interim Storage Assembly
IU	Instrumentation Unit
IVC	Intervehicular Communications
IVT	Intravehicular Transfer
JETT	Jettison
KM	Kilometer
kwh	Kilowatt Hour
LA	Launch Azimuth
LAT	Latitude
LBR	Low Bit Rate (TLM)
LBS or lbs	Pounds
LCG	Liquid Cooled Garment
LDG	Landing
LDMK	Landmark
LEB	Lower Equipment Bay
LEC	Lunar Equipment Conveyor
LFH	Lunar Far Horizon
LGC	LM Guidance Computer
LH	Left-hand
L/H	Local Horizontal
LHEB	Left-hand Equipment Bay
LHFEB	Left-hand Forward Equipment Bay
LHSSC	Left Hand Side Storage Container
LiOH	Lithium Hydroxide
LLM	Lunar Landing Mission
LLOS	Landmark Line of Sight
LM	Lunar Module
LMP	Lunar Module Pilot
LNH	Lunar Near Horizon
LOI	Lunar Orbit Insertion
LONG	Longitude
LOS	Loss of Signal or Loss of Site
LPO	Lunar Parking Orbit
LR	Landing Radar
LRRR or LR3	Laser Ranging Retro-Reflector
LS	Landing Site
LT	Light
LTG	Lighting
LV	Launch Vehicle
L/V	Local Vertical
LVPD	Launch Vehicle Pressure Display
M	Mandatory
MAD	Madrid, Spain
MAN	Manual
MAX	Maximum
MAX Q	Maximum Dynamic Pressure
MCC	Midcourse Correction
MCC-H	Mission Control Center - Houston
MCC	Mission Control Center
MDC	Main Display Console
MEAS	Measurement
MER	USNS Mercury
MESA	Modularized Equipment Stowage Assembly
MET	Mission Event Timer
MGA	Middle Gimbal Angle
M/I	Minimum Impulse
MIN	Minimum
MLA	Merrit Island, Florida
MNVR	Maneuver
MPS	Main Propulsion System
MSFN	Manned Space Flight Network
MTVC	Manual Thrust Vector Control

N2	Nitrogen
NAV	Navigation
NM	Nautical Miles
NOM	Nominal
NXX	Noun XX
O2	Oxygen
OBS	Observation
O/F	Oxidizer to Fuel Ratio
OGA	Outer Gimbal Angle
OMNI	Omnidirectional Antenna
OPS	Oxygen Purge System
ORB	Orbital
ORDEAL	Orbit Rate Display Earth and Lunar
ORIENT	Orientation
OVHD	Overhead
P	Pitch or Program
PAD	Voice Update
PCM	Pulse Code Modulation
PC	Plane Change
PDI	Powered Descent Initiation
PGA	Pressure Garment Assembly
PGNCS	Primary Guidance Navigation Control Section
PIPA	Pulse Integrating Pendulous Accelerometer
PLSS	Personal Life Support Systems
PM	Phase Modulated
POL	Polarity or Polarizing
PRE	Pretoria, South Africa
PREF	Preferred
PREP	Preparation
PRESS	Pressure
PRIM	Primary
PROP	Proportional
PSE	Passive Seismic Experiment
PT	Point
PU	Propellant Utilization
PUGS	Propellant Utilization and Gaging System
PTC	Passive Thermal Control
PWR	Power
PXX	Program XX
Qty	Quantity
R	Roll or Range
R&B	Red & Blue
RAD	Radiator
RCDR	Recorder
RCS	Reaction Control System
RCU	Remote Control Unit
RCV	Receiver
RED	USNS Redstone
REFSMMAT	Reference Stable Member Matrix
REG	Regulator
REQD	Required
RH	Right-hand
RING	Ringsite
RLS	Radius of Landing Site
RNDZ	Rendezvous
RR	Rendezvous Radar
RSI	Roll Stability Indicator
RT	Real Time
RTC	Real Time Command
RXX	Routine XX
SA	Shaft Angle
S/C	Spacecraft
SCE	Signal Conditioning Equipment
SCS	Stabilization Control System
SCT	Scanning Telescope



SEC	Secondary
SECO	S-IVB Engine Cut-off
SECS	Sequential Events Control System
SEP	Separate
SEQ	Sequence
S-IVB	Saturn IV B(Third Stage)
SLA	Service Module LM Adapter
SLOS	Star Line-of-Sight
SM	Service Module
SPOT	Spot Meter
SPS	Service Propulsion System
SR	Sunrise
SRC	Sample Return Container
SRX	S-Band Receiver Mode No. X
SS	Sunset
STX	S-Band Transmit Mode No. X
S.V.	State Vector
SWC	Solar Wind Composition
Sw	Switch
SXT	Sextant
T EPHEM	Time of Ephemeris Update
TA	Trunnion Angle
TAN	Tananarive, Madagascar
TB	Time Base
TCA	Time of Closest Approach
TD&E	Transposition Docking & LM Ejection
TEC	Trans Earth Coast
TEI	Transearch Insertion
TEMP	Temperature
TERM	Terminate
TEX	Corpus Christi, Texas
TGT	Target
TIG	Time of Ignition
TLC	Trans Lunar Coast
TLI	Translunar Insertion
TLM or TM	Telemetry
TPF	Terminal Phase Final
TPI	Terminal Phase Initiation
TPM	Terminal Phase Midcourse
T/R	Transmitter/Receiver
TRANS	Translation
TV	Television
TVC	Thrust Vector Control
TWR	Tower
US	United States
V	Velocity
VAN	USNS Vanguard
VHF	Very High Frequency
VLV	Valve
VI	Inertial Velocity
VOX	Voice Keying
VXX	Verb XX
W/O	Without
WRT	With Respect to
WTN	USNS Watertown
XFER	Transfer
XMIT	Transmit or Transmitter
XPONDER	Transponder
Y	Yaw

$\Delta V$  Velocity Change (Differential)  
 $\Delta VC$  Velocity Change at Engine Cutoff  
 $\Delta R$  Position Change (Differential)

8-balls Flight Director Attitude Indicator (FDAI)

#### CAMERA NOMENCLATURE

EL/250/BW-BRKT

Electric Hasselblad/250mm Lens/Black & White film-Camera Bracket

INT (f5.6,250,INF)

Intervalometer (f-stop 5.6, shutter speed=1/250 sec, Infinity)

16mm/18/CEX-BRKT

16mm Camera/18mm Lens/Color Film External-Camera Bracket

MIR (f8,250,INF) 6fps

Mirror (f-stop 8, shutter speed=1/250 sec, Infinity) 6 frames per sec

SYMBOL NOMENCLATURE

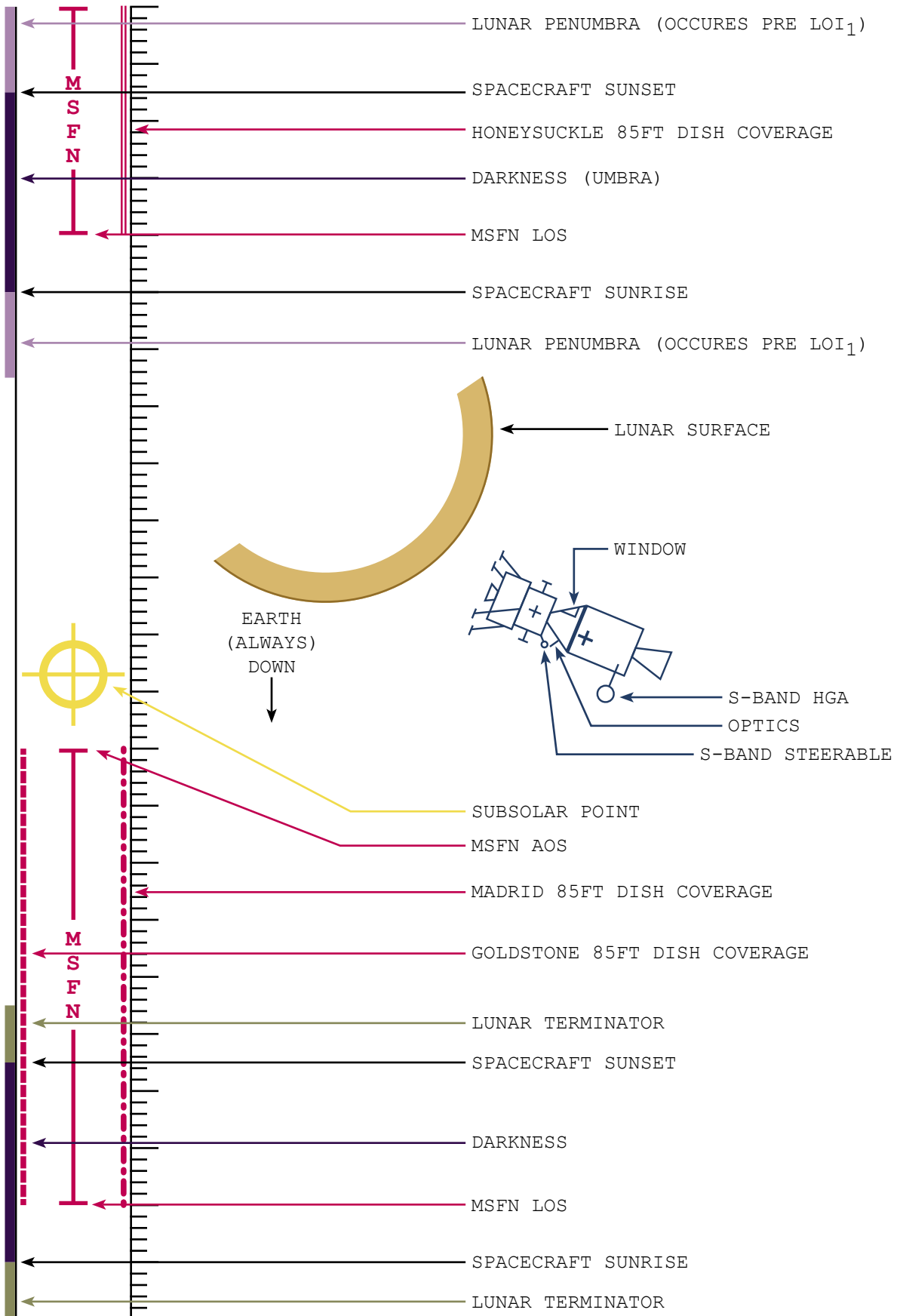

## INTRODUCTION

This Flight Plan has been prepared by the Flight Planning Branch, Flight Crew Support Division, with technical support by TRW Systems.

This document schedules the AS-506/CSM-107/LM-5 operations and crew activities to fulfill, when possible, the test objectives defined in the Mission Requirements, G Type Mission Lunar Landing.

The trajectory parameters used in this Flight Plan are for July 16, 1969 launch, with a 72° launch azimuth and were supplied by Mission Planning and Analysis Division as defined by the Apollo Mission G Spacecraft Operational Trajectory.

The Apollo 11 Flight Plan is under the configuration control of the Crew Procedures Control Board (CPCB). All proposed changes to this document that fall in the following categories should be submitted to the CPCB via a Crew Procedures Change Request:

1. Items that impose additional crew training or impact crew procedures.
2. Items that impact the accomplishment of detailed test objectives.
3. Items that result in a significant RCS or EPS budget change.
4. Items that result in moving major activities to a different activity day in the Flight Plan.
5. Items that require a change to the flight data file.

The Chief, Flight Planning Branch (FCSD) will determine what proposed changes fall in the above categories.

Mr. T. A. Guillory will act as co-ordinator for all proposed changes to the Apollo 11 Flight Plan.

Any requests for additional copies or changes to the distribution lists of this document must be made in writing to Mr. W. J. North, Chief, Flight Crew Support Division, MSC, Houston, Texas.

SECTION I

**GENERAL**



## MISSION DESCRIPTION

1. Launch and EPO (Duration 2:44) LIFT OFF - 2:44 GET
  - (a) Nominal launch time is 9:32 EDT, July 16, 1969, with a launch window duration of 4 hrs. 24 min,
  - (b) Earth orbit insertion into a 100 nm, circular orbit at 11 min. 43 sec. after lift-off
  - (c) CSM systems C/O in earth orbit
  - (d) Optional IMU realign (P52) to the pad REFSMMAT during the first night period
  - (e) TLI occurs at 2:44:26 GET over the Pacific Ocean during the second revolution. (See Table 1-1 for burn data).
  
2. Translunar Coast (Duration 73:10) 2:44 - 75:54 GET

After TLI, which places the spacecraft in a free lunar return trajectory, the following major events occur prior to LOI:

  - (a) Transposition, docking and LM ejection, including SIVB photography
  - (b) Separation from SIVB and a CSM evasive maneuver
  - (c) SIVB propulsive venting of propellants (slingshot)
  - (d) Two series of P23 cislunar navigation sightings, star/earth horizon, consisting of five sets at 06:00 GET and five sets at 24:30 GET
  - (e) Four midcourse corrections which take place at TLI +9, TLI +24, LOI -22 and LOI -5 hours with DV nominally zero (See Table 1-1).
  - (f) Passive thermal control (PTC) will be conducted during all periods when other activities do not require different attitudes.
  - (g) LM inspection and housekeeping
  - (h) LOI<sub>1</sub>, performed at 75:54:28 GET, ends the TLC phase.

3. Lunar Orbit (Duration 59:30) 75:54 - 135:24 GET

LOI Day (Duration 25:00) 69:00 - 94:00

- (a) LOI<sub>1</sub>
- (b) Photos of targets of opportunity
- (c) LOI<sub>2</sub>
- (d) Post LOI<sub>2</sub> LM entry and inspection. S-Band/UHF B Voice tests will be conducted.
- (e) Post LOI<sub>2</sub> Pseudo landmark tracking (one set of sightings)  
(See Table 1-4)
- (f) Rest period of 9 hours

DOI and EVA Day (Duration 28:00) 94:00 - 122:00 GET

- (a) Docked LM activation and checkout
- (b) Docked landing site landmark sighting (one set of sightings)  
(See Table 1-3)
- (c) Undocking and separation
- (d) DOI thru landing (See Figure 1-3 Powered Descent)
- (e) LM post touchdown and simulated liftoff
- (f) Rest period (LM) of 4 hours
- (g) CSM plane change
- (h) Rest period (CSM) of 4 hours
- (i) EVA prep
- (j) EVA for 2 hours 40 minutes
- (k) Post EVA
- (l) Rest period (LM) 4 hours 40 minutes
- (m) Rest period (CSM) 4 hours 50 minutes

Ascent and TEI Day (Duration 25:00) 122:00 - 147:00 GET

- (a) LM Lift-Off and Insertion
- (b) LM active rendezvous
  - CSI
  - PC
  - CDH
  - TPI
  - Braking



- (c) Docking
  - (d) LM jettison
  - (e) TEI
  - (f) Rest Period
4. Lunar Orbit Particulars (Average Values for a 60 x 60 nm orbit)
- (a) Revolutions start at 180° longitude
  - (b) Revolution duration - 1 hr. 58.2 min.
  - (c) S/C night period duration - 47 min.
  - (d) MSFN coverage per rev. - 72 min.
  - (e) Orbit inclination - 1.25° for July 16, 1969 launch
  - (f) S/C orbital rate - 3°/min. (.05°/sec)
  - (g) Lighting change at fixed ground point - 1°West/Rev.
  - (h) Horizon visibility ± 20° selenocentric angle on the lunar surface
  - (i) One lunar degree on lunar surface is 16.35 nm
  - (j) Site 2 will be visible (3° sun angle) at REV. 7
  - (k) S/C subvehicle point to horizon 327 nm.
5. Transearch Coast and Entry (Duration 59:39) 131:52 - 195:03 GET
- Transearch coast begins with TEI at 135:24:34 GET and consists of the following major events:
- (a) Three midcourse corrections are scheduled at TEI +15, EI -23 and EI -3 hours with DV nominally zero.
  - (b) CM/SM separation takes place at 194:51 GET and Entry Interface occurs at 195:03 GET.
  - (c) Splashdown will occur in the Pacific Ocean at a longitude of about 172.4° West at 195:17 GET. This will occur approximately 25 minutes prior to sunrise local time.



FIGURE 1-1  
MISSION SUMMARY FLIGHT PLAN

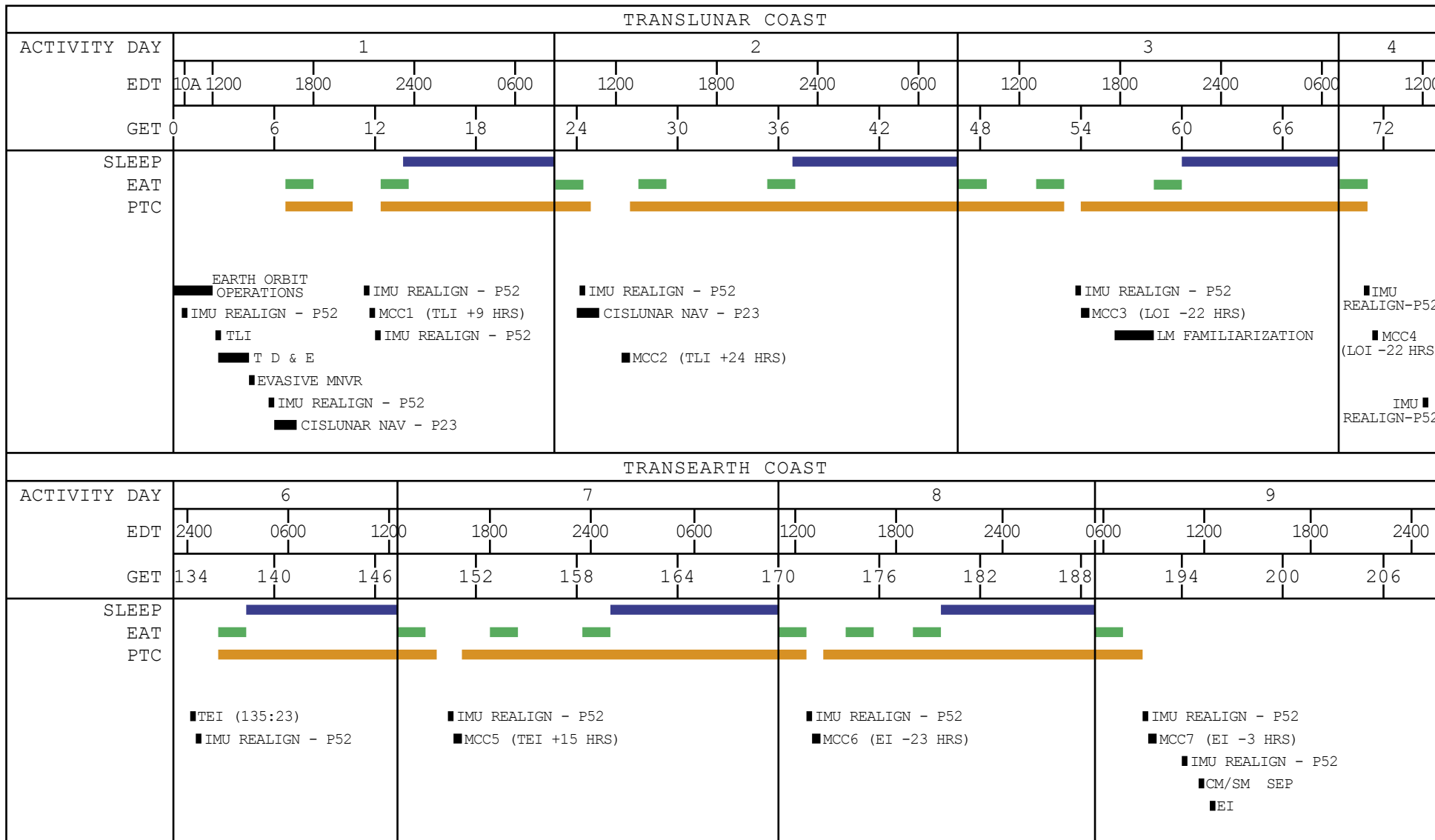

LUNAR ORBIT SUMMARY FLIGHT PLAN FIG 1 - 2

ACTIVITY DAY	4 (LOI DAY)														5 (DOI - EVA DAY)														6 (ASCENT - TEI DAY)																											
SLEEP																																																								
EDT	1330	1530	1730	1930	2130	2330	0130	0330	0530	0730	0930	1130	1330	1530	1730	1930	2130	2330	0130	0330	0530	0730	0930	1130	1330	1530	1730	1930	2130	2330	0130																									
GET	76	78	80	82	84	86	88	90	92	94	96	98	100	102	104	106	108	110	112	114	116	118	120	122	124	126	128	130	132	134	136																									
REV NO.	1	2	3	4	5	6	7	8	9	10	11	12	13	14	15	16	17	18	19	20	21	22	23	24	25	26	27	28	29	30																										
LM (CDR - LMP)	LMP IVT to LM ENTRY STATUS CHECKS HOUSEKEEPING COMM CHECKS CLOSEOUT, IVT to LM														LMP- PRIM GLYCOL C&W CK CB and PGNCs ACTIVATION CDR IVT to LM ECS ACTIVATION S-BAND CHECKS SUIT FAN/H2O SEP. GLYCOL PUMP CKS VHF ACTIVATION CHECKOUT LMP IVT to CSM DON PGA IVT to LM IMU DOCKED COARSE ALIGN LMP CONNECT to LM ECS CDR ASSIST CMP CLOSE and SECURE LM HATCH ASCENT BATTERY ACT and CHECKOUT DON HELMET & GLOVES ARS/PGA CHECKS CABIN REGULATOR CHECK DOFF HELMET & GLOVES FINE ALIGN IMU AGS ACTIVATION and SELF TEST DEPLOY LANDING GEAR INITIALIZE AGS RCS PRESSURIZE and CHECKOUT RR ACT & SELF TEST DPS PRESS and CHECKOUT DON HELMET & GLOVES UNDOCK MNVR for INSPECTION AGS UPDATE, ALIGN RR, VHF RANGING CKS and LR SELF TEST IMU REALIGN P52 DOI PREP PD PREP POWERED DESCENT TOUCHDOWN														POST TOUCHDOWN CHECKLIST BEGIN SIMULATED COUNTDOWN P57, GRAVITY MEASURE P57, 2 CELESTIAL BODIES P57, GRAVITY & 1 CELESTIAL BODY END SIMULATED COUNTDOWN EAT PERIOD														AGS TURN ON, SELF TEST P57, GRAVITY & 1 CELESTIAL BODY EAT PERIOD VERIFY AGS P57, GRAVITY CELESTIAL BODY ASCENT PREP INSERTION RR SELF TEST IMU REALIGN P52 PLSS/OPS DONNING PLSS/EVCS ELECTRICAL CK FINAL EVA EQUIP CK FINAL SYSTEMS PREP PREP FOR CABIN DEPRESS PRESSURE INTEGRITY CK 2 hr 40 min EVA POST EVA SYSTEMS CONFIG PLSS/OPS DOFFING FINAL SYSTEMS CONFIG PREP FOR EQUIP JET PRESSURE INTEGRITY CK CABIN DEPRESS HATCH OPENING CABIN REPRESS FINAL SYSTEMS CONFIG POST EVA CABIN CONFIG EAT PERIOD													
CSM (CMP)	LOI-1 PREP LOI-1 EAT (ALL) IMU REALIGN P52 LOI-2 PREP LOI-2 IMU REALIGN P52 TRACK PSEUDO LDMK EAT PERIOD (ALL)														EAT (ALL) CDR & LMP DON LGC CMP DON PGA IMU REALIGN P52 INSTALL PROBE and DROGUE. CLOSE HATCH TRACK PSEUDO LANDMARK A-1 UNDOCK INSPECT LM SEPARATION IMU REALIGN P52 SXT TRACK LM														IMU REALIGN P52 SXT TRACK LANDED LM IMU REALIGN P52, PULSE TORQUE EAT PERIOD PLANE CHANGE PREP PLANE CHANGE IMU REALIGN P52, PULSE TORQUE EAT PERIOD PHOTOGRAPH LANDED LM EAT PERIOD														EAT PERIOD IMU REALIGN P52 VHF/SXT TRACK LM BACKUP LM CSI BURN BACKUP LM CDH BURN MONITOR MCC & BRAKING TRANSFER & STOW EQUIPMENT CLOSE CSM HATCH PREP for JETTISON JETTISON LM IMU REALIGN P52 EAT PERIOD PREP for TEI IMU REALIGN P52 FINAL PREP for TEI TEI													
SLEEP																																																								
GET	76	78	80	82	84	86	88	90	92	94	96	98	100	102	104	106	108	110	112	114	116	118	120	122	124	126	128	130	132	134	136	138																								

1 - 9

# LM POWERED DESCENT

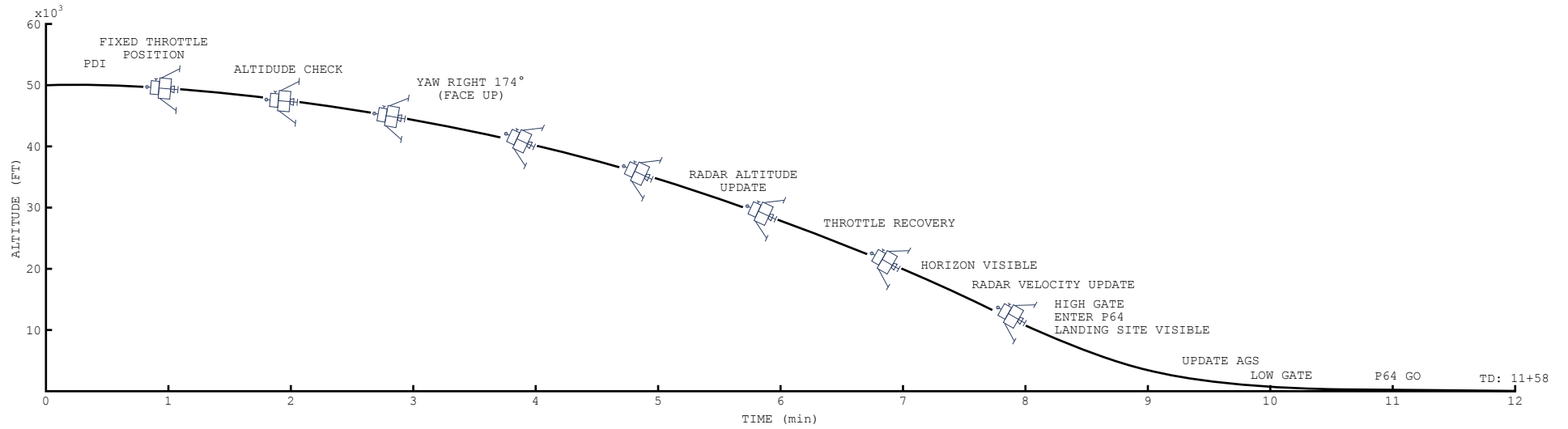

1 - 1  
L - L

## LM POWERED DESCENT - TERRAIN PROFILE

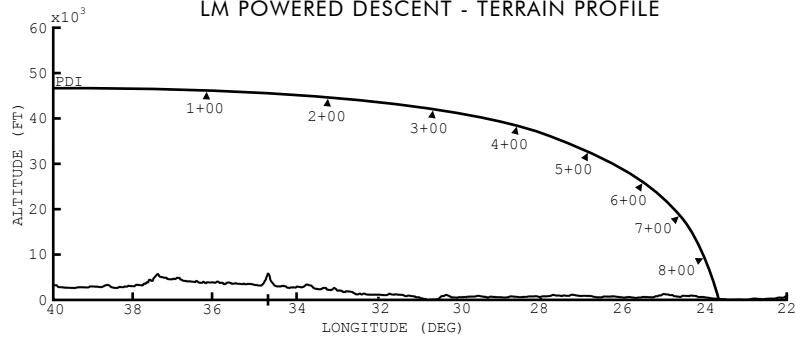

## LM POWERED DESCENT - HIGH GATE TO TD

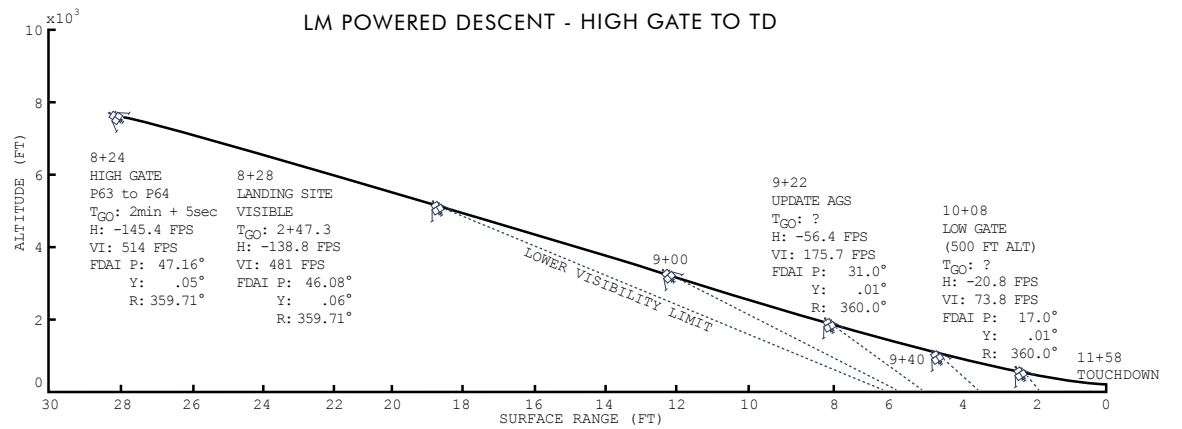

TABLE 1-1 CSM BURN SCHEDULE

BURN / MANEUVER	GETI BURN TIME ΔVC	ATTITUDE (DEG)		LIGHTING	ΔV (FPS)	ULLAGE	TVC MODE	REFSMAT	S/C WT. RESULTANT HA, HP	REMARKS
		LH/LV	INERTIAL							
S-IVB TLI	02:44:26 5 MIN 20 SEC			BURNOUT AT SUNRISE	ΔVX: -- ΔVY: -- ΔVZ: -- ΔV REQ: 10,451.2	----	----	PAD	WT: -- HP: -- HA: --	S-IVB BURN
CSM/LM S-IVB EVASIVE MNVR	04:39:44.9 2.8 SEC 15.6 FPS			DAYLIGHT	ΔVX: 5.1 ΔVY: 0.0 ΔVZ: 19.0 ΔV REQ: 19.7	NOT REQUIRED	G&N AUTO	PAD	WT: 96662.3 HP: 123.8 HA: 281953.9	SPS BURN
MIDCOURSE CORRECTIONS MCC <sub>1</sub> TO MCC <sub>4</sub>	11:45 26:45 53:55 70:55			----	ΔVX: NOMINALLY ΔVY: ZERO ΔVZ: ΔV REQ:	NOT REQUIRED	G&N AUTO	PAD PTC PTC LDG SITE	----	TLI +9 TLI +24 LOI -22 LOI -5
LOI <sub>1</sub>	75:54:28.4 5 MIN 58.9 SEC 2914.8 FPS			DAYLIGHT (SS -1 HR 7 MIN)	ΔVX: -2891.8 ΔVY: -433.1 ΔVZ: 20.4 ΔV REQ: 2924.1	NOT REQUIRED	G&N AUTO	LDG SITE	WT: 95207.4 HP: 59.2 HA: 169.8	SPS BURN
LOI <sub>2</sub>	80:09:29.7 16.4 SEC			DAYLIGHT (SR +9 MIN)	ΔVX: 138.3 ΔVY: 0.0 ΔVZ: 75.9 ΔV REQ: 157.8	2 JET 20 SEC	G&N AUTO	LDG SITE	WT: 71320.81bs HP: 53.6 HA: 65.6	SPS BURN
CSM/LM SEP	100:39:50.4 8 SEC			SUNLIGHT (SS -14 MIN)	ΔVX: 0.0 ΔVY: 0.0 ΔVZ: 2.5 ΔV REQ: 2.5	----	G&N AUTO	LDG SITE	WT: 36407.9 HP: 55.6 HA: 63.1	RCS BURN
*CSM PLANE CHANGE	107:05:33.4 0.8 SEC 5.7 FPS			DARKNESS (SS +17 MIN)	ΔVX: 0.0 ΔVY: 16.6 ΔVZ: 0.0 ΔV REQ: 16.6	2 JET 20 SEC	G&N AUTO	PLANE CHANGE	WT: 36325.4 HP: NO CHANGE HA: NO CHANGE	SPS BURN
LM JETTISON	131:53:04.7 3.1 SEC 0.8 FPS			DAYLIGHT (SR +36 MIN)	ΔVX: -1.0 ΔVY: -- ΔVZ: -- ΔV REQ: 1.0	----	G&N AUTO	LIFT OFF	WT: 36154.7 HP: 58.5 HA: 59.4	RCS BURN
TEI	135:24:33.8 2 MIN 29.4 SEC NOT AVAILABLE			DAYLIGHT (SR +10 MIN)	ΔVX: 3213.3 ΔVY: 705.0 ΔVZ: -138.8 ΔV REQ: 3292.7	2 JET 16 SEC	G&N AUTO	LIFT OFF	WT: 36111.4 HP: -- HA: --	SPS BURN
MIDCOURSE CORRECTIONS MCC <sub>5</sub> TO MCC <sub>7</sub>	150:24 172:00 192:06			----	ΔVX: ΔVY: NOMINALLY ΔVZ: ZERO ΔV REQ:	----	G&N AUTO	PTC PTC ENTRY	----	TEI +15 EI -23 EI -3

TABLE 1-2 LM BURN SCHEDULE

BURN / MANEUVER	GETI BURN TIME ΔVC	ATTITUDE (DEG)		LIGHTING	ΔV (FPS)	ULLAGE	TVC MODE	REFSMAT	S/C WT. RESULTANT HA, HP	REMARKS
		LH/LV	INERTIAL							
DOI	101:38:48 28:5 SEC			DARKNESS (SR -4 MIN)	ΔVX: 67.46 ΔVY: -28.68 ΔVZ: -12.51 ΔV REQ: 70	2 JET 7.5 SEC 1.3 FPS	PGNCS AUTO	LDG SITE	WT: 33,404 HP: 8.97 HA: 57.87 nM	DPS BURN
PDI	102:35:13 11 MIN 58 SEC			DAYLIGHT	ΔVX: - ΔVY: - ΔVZ: - ΔV REQ: 6766	2 JET 7.5 SEC 1.3 FPS	PGNCS AUTO	LDG SITE	WT: 16,569 HP: 0 HA: 0	DPS BURN
ASCENT	124:23:26 7 MIN 18 SEC			DAYLIGHT	ΔVX: - ΔVY: - ΔVZ: - ΔV REQ: 6060	----	PGNCS AUTO	LIFT OFF	WT: 5,894 AT INS HP: 60,000 ft HA: 45 nM	APS BURN
CSI	125:21:19.1 45:0 SEC			DARKNESS (SR -1 MIN)	ΔVX: 49.5 ΔVY: 0.0 ΔVZ: 0.0 ΔV REQ: 49.5	----	PGNCS AUTO	LIFT OFF	WT: 5875.0 HP: 44.9 HA: 45.0	RCS BURN
PLANE CHANGE	125:50:28 0			DAYLIGHT (SR +25 MIN)	ΔVX: 0.0 ΔVY: 0.0 ΔVZ: 0.0 ΔV REQ: 0.0	----	PGNCS AUTO	LIFT OFF	WT: - HP: - HA: -	RCS +Y 2 JET BURN NOMINALLY ZERO
CDH	126:19:37.0 1.9			DAYLIGHT (SS -19 MIN)	ΔVX: -1.1 ΔVY: 0.0 ΔVZ: 4.1 ΔV REQ: 4.3	----	PGNCS AUTO	LIFT OFF	WT: 5842.9 TIG HP: 43.8 HA: 45.3	RCS BURN
TPI	126:58:08.4 22.4 SEC			DARKNESS (SR -23 MIN)	ΔVX: 22.0 ΔVY: 0.0 ΔVZ: -11.1 ΔV REQ: 24.8	----	PGNCS AUTO	LIFT OFF	WT: 5840.1 HP: 43.3 HA: 61.7	RCS BURN
MCC <sub>1</sub>	127:13:08 0			DARKNESS (SR -8 MIN)	ΔVX: 0.0 ΔVY: 0.0 ΔVZ: 0.0 ΔV REQ: 0.0	----	PGNCS AUTO	LIFT OFF	WT: - HP: - HA: -	RCS +Z 2 JET BURN NOMINALLY ZERO
MCC <sub>2</sub>	127:28:08 0			DAYLIGHT (SR +7 MIN)	ΔVX: 0.0 ΔVY: 0.0 ΔVZ: 0.0 ΔV REQ: 0.0	----	PGNCS AUTO	LIFT OFF	WT: - HP: - HA: -	RCS +Z 2 JET BURN NOMINALLY ZERO
1st BRAKING MNVR	127:36:57 0			DAYLIGHT (SR +15 MIN)	ΔVX: 0.0 ΔVY: 0.0 ΔVZ: 0.0 ΔV REQ: 0.0	----		LIFT OFF	WT: - HP: - HA: -	RCS -Z 2 JET BURN NOMINALLY ZERO
2nd BRAKING MNVR	127:39:24.5 10.8 SEC			DAYLIGHT (SR +18 MIN)	ΔVX: - ΔVY: - ΔVZ: - ΔV REQ: 12.0	----	PGNCS AUTO	LIFT OFF	WT: 5824.1 HP: 49.0 HA: 60.7	RCS -Z 2 JET
3rd BRAKING MNVR	127:40:32.8 8.8 SEC			DAYLIGHT (SR +20 MIN)	ΔVX: - ΔVY: - ΔVZ: - ΔV REQ: 9.8	----	PGNCS AUTO	LIFT OFF	WT: 5816.4 HP: 53.7 HA: 60.3	RCS -Z 2 JET
4th BRAKING MNVR	127:42:16.1 4.3 SEC			DAYLIGHT (SR +21 MIN)	ΔVX: - ΔVY: - ΔVZ: - ΔV REQ: 4.6	----	PGNCS AUTO	LIFT OFF	WT: 5810.1 HP: 56.2 HA: 60.1	RCS -Z 2 JET
5th BRAKING MNVR	127:43:35.7 4.2 SEC			DAYLIGHT (SR +23 MIN)	ΔVX: - ΔVY: - ΔVZ: - ΔV REQ: 4.7	----	PGNCS AUTO	LIFT OFF	WT: 5807.0 HP: 69.9 HA: 58.9	RCS -Z 2 JET

TABLE 1-3 LUNAR LANDING SITE DATA

DAY	SITE DESIG	LATITUDE	LONGITUDE	<sup>1</sup> LAUNCH AZIMUTH/ SUN ELEVATION	<sup>2</sup> LAUNCH AZIMUTN/ SUN ELEVATION
JULY 16 0932 EDT	2(IIP6)	00°42'50"N 00.71388889°N (00.6914°N)	23°42'28"E 23.70777778°E (23.7169°E) <sup>3</sup>	72°/10.5°	108°/13.5°
JULY 18 1132 EDT	3(IIP8)	00°21'10"N 00.35277778°N	01°17'57"W 01.29916667°W	89.295°/11°	108°/13°
JULY 21 1209 EDT	5(IIP13)	01°40'41"N 01.67805556°N	41°53'57"W 41.89916667°W	94.6775°/9.7°	108°/11.7°

Data From TJ memo, Accuracy Estimates, Landing Site Landmarks, May 12, 1969, TJ-69-499.

<sup>1</sup>Sun Elevation Angles Are For Approximately 27 Hours After LOI, 1st Opportunity TLI.

<sup>2</sup>Includes 2nd Opportunity TLI.

<sup>3</sup>Data From MPAD memo, landing site coordinates for G, June 12, 1969, 69-FM41-181.

TABLE 1-4 LANDMARK TRACKING DATA  
July 16 Launch

LANDMARK DESIG.	LATITUDE	LONGITUDE	DELTA ALTITUDE (nm)	SUN EL
A1 (Pseudo)	2°N 2.000°N	65° 30'E 60.500°E	000.00	43°
IP(130)	1°53'N 1.885°N	28°42'E 28.726°E	000.00	--
130 (Prime LDG SITE 2)	01°15'56"N 01.26555556°N (01.24307°N)	23°40'44"E 23.67888889°E (23.6880°E) <sup>1</sup>	-001.68	8.5°
123 (Alternate LDG SITE 2)	00°30'19"N 00.50527778°N	24°53'20"E 24.88888889°E	-001.71	--
129 (Alternate LDG SITE 2)	01°17'06"N 01.28500000°N	23°44'37"E 23.74361111°E	-001.76	--
133 (Alternate LDG SITE 2)	00°47'14"N 00.78722222°N	23°30'55"E 23.51527778°E	-001.68	--

<sup>1</sup>Data from MPAD memo, landing site 2 position, June 20, 1969, 69-FM41-199.



TABLE 1-4 LANDMARK TRACKING DATA (CONT'D)  
July 18 Launch

LANDMARK DESIG.	LATITUDE	LONGITUDE	DELTA ALTITUDE (nm)	SUN EL
IP(G1)	0°16'N 0.267°N	32°19'E 32.317°E	--	--
G1(129)	01°17'06"N 01.28500000°N	23°44'37"E 23.74361111°E	-001.97	26°
IP(143)	00°18'N 00.300°N	3°23'E 3.383°E	--	--
143(Prime LDG SITE 3)	00°36'51"N 00.61416667°N	01°04'39"W 01.07750000°W	-001.01	9°
150(Alternate LDG SITE 3)	00°16'59"N 00.28305556°N	01°25'43"W 01.42861111°W	-001.01	--
147(Alternate LDG SITE 3)	00°03'42"N 00.06166667°N	01°16'36"W 01.27666667°W	-000.99	--

TABLE 1-4 LANDMARK TRACKING DATA (CONT'D)  
July 21 Launch

LANDMARK DESIG.	LATITUDE	LONGITUDE	DELTA ALTITUDE (nm)	SUN EL
IP(G1)	0°30'S 0.500°S	26°33'W 26.550°W	--	--
G1	1°42'N 1.696°N	32°10'W 32.162°W	-001.77	8°
IP(180)	0°36'N 0.608°N	36°34'W 36.567°W	--	--
180(PRIME LDG SITE 5)	01°30'37"N 01.51027778°N	41°49'05"W 41.81805556°W	-001.25	8.9°
171(Alternate LDG SITE 5)	01°20'04"N 01.33444444°N	40°47'34"W 40.79271778°W	-001.29	--
178(Alternate LDG SITE 5)	01°45'33"N 01.75916667°N	41°34'12"W 41.57000000°W	-001.22	--
184(Alternate LDG SITE 5)	02°03'10"N 02.05277778°N	42°13'41"W 42.22805556°W	-001.23	--



FLIGHT PLAN NOTES

A. Crew

1. Crew designations are as follows:

<u>Designation</u>	<u>Prime</u>	<u>Backup</u>
Commander (CDR)	Armstrong	Lovell
Command Module Pilot (CMP)	Collins	Anders
Lunar Module Pilot (LMP)	Aldrin	Haise

2. Crew positions during the mission are as follows:

	<u>CSM</u>			<u>LM</u>	
	<u>Left</u>	<u>Center</u>	<u>Right</u>	<u>Left</u>	<u>Right</u>
Launch thru TLI	CDR	LMP	CMP		
T&D thru Entry	CMP	CDR	LMP		
Manned LM				CDR	LMP

3. The crew will eat and sleep simultaneously throughout the mission. Eat periods will be normally 1-hour duration, with additional activities held to a minimum during this time frame. Sleep periods will normally be 8 to 10 hour duration with two 4 to 5 hour sleep periods while the LM is on the lunar surface.

4. Activity

PGA Configuration

Launch to insertion	PGA's with helmet & gloves (H&G)
Insertion to TLI	PGA's without H&G
TLI to evasive mnvr	PGA's with H&G
TLC & LOI 1&2	Constant wear garments
LM activation & checkout	PGA without H&G (CMP H&G donned for latch cocking & CDR/LMP H&G donned for pressure integrity check and cabin reg check)
Undocking through touchdown	PGA's with H&G except CMP without H&G after DOI
Touchdown through pre lift-off	PGA's without H&G except for CDR/LMP simulated count- down & EVA
Liftoff through LM jettison	PGA's with H&G (except H&G off after docking)
LM jettison through splashdown	Constant wear garmets

5. Two crew status reports via air-to-ground commmunications will be made by the flight crew during each activity day. The first report will be given after the first meal of the day and will concern the sleep obtained during the previous sleep period. The second report will be given following the final meal of the day and will concern the radiation dose received during the previous 24 hours and medication taken if any. The following information should be logged:

- a. Food Consumption
- b. Exercise
- c. Used fecal bags marked as to crewman and GET

6. Negative reporting will be used in reporting completion of each checklist.

7. Continuous CSM biomedical data are automatically transmitted to the ground.

8. LM biomedical switching is performed manually by the LMP from undocking to docking as scheduled in the timeline.

9. All onboard gage readings will be read directly from the gages. and will not be corrected by the appropriate calibration factors.

## B. Photography

Photographic requirements were derived from the following:

- a. Lunar Surface Operations Plan
- b. Photographic Operations Plan

## C. Procedures

### 1. CSM

Crew procedures called out in the flight plan may be found in the following documents:

- a. Apollo Operations Handbook - CSM-107 (AOH), Volume 1/2
- b. Crew Checklist
- c. CSM Rendezvous Procedure
- d. Abort Summary Document
- e. Apollo Entry Summary Document
- f. Photographic Operations Plan
- g. Descent Procedures Document
- h. Ascent Procedures Document
- i. Lunar Landmark Tracking Attitude Studies
- j. Lunar Orbit Attitude Sequence for Mission G
- k. Data Priority Documents

### 2. LM

Crew procedures called out in the flight plan may be found in the following documents:

- a. Apollo Operations Handbook LM-5 Volume 1/2
- b. Crew Checklist
- c. LM Rendezvous Procedures
- d. LM Descent/Ascent Summary Document
- e. Lunar Landing Phase Photographic Operations Plan
- f. Data Priority Documents
- g. EVA Procedures
- h. Apollo Lunar Surface Operations Plan

## D. Communications

### 1. General

- a. CSM and LM HBR data transmissions in lunar orbit will normally require the use of the high gain or steerable antennas
- b. During communications, the spacecraft will be referred to by name (Apollo 11) and MCC-H will be referred to as Houston.
- c. The preferred S-Band communications are:
  - (1) CSM
    - (a) Uplink Mode 6 (Voice, PRN, and Updata)
    - (b) Downlink Mode 2 (Voice, PRN, TLM-HBR)
  - (2) LM
    - (a) Uplink Mode 7 (Voice, Updata)
    - (b) Downlink Mode 1 (Voice, TLM-HBR)
- d. LM voice recorder has a maximum utilization of 10 hours. This recorder will be used during LM operations to record all LM voice data during undocked operations (27 hours 42 minutes). This recorder will be operated in the VOX mode.
- e. A small portable voice recorder will be carried in the CM to be used at the discretion of the crew as a voice recorder back-up. This recorder will not be transferred to the LM for use during undocked operations.
- f. The S-band "squelch" will be on during the sleep periods in order to prevent MSFN fade-out noise from disturbing the crew.

## 2. DSE Operation

- a. The DSE will normally be operated via ground command except for special cases where the operation is time limited. In these cases the crew may be asked to rewind the tape.
- b. During the earth orbit period when the CSM is not over a MSFN station, CSM TLM-LBR data will be recorded on the DSE and will be dumped during the pass over the US and over CRO prior to TLI if possible.
- c. DSE will be used for CSM HBR and voice recording during all CSM engine burns.
- d. DSE data and voice recordings will be made in CSM LBR mode whenever possible in order to minimize the DSE dump time.
- e. During PTC using the HGA REACQ communications mode the DSE will be used to record LBR data when the HGA is not in the MSFN field of view.
- f. During lunar orbit LM operations, the DSE will be used to record LM-TLM-LBR data during all docked LM activities that occur on the lunar farside. For undocked LM activities only DOI will be recorded as VHF ranging is required.
- g. DSE will be used to record all HBR entry data during the blackout region.

## 3. Launch - Earth Orbit Phase

- a. OMNI B and VHF LEFT will be selected for lift off. OMNI D will be selected by the crew during boost phase if the launch azimuth is less than 96° or OMNI C if the launch azimuth is greater than 96°. OMNI D will probably be the best antenna for earth orbit.
- b. VHF Duplex B will be used for launch, and Simplex A for earth orbit operations.
- c. VHF Simplex A will be used for entry to be compatible with recovery forces communications.

## 4. Translunar and Transearth Coast Phase

The translunar and transearth sleep communications mode will be as follows. The CSM x-axis will be placed normal to the ecliptic plane. The CSM will be rolled at a rate of approximately three revolution per hour. During the near earth sleep periods prior to 30 hours GET (range less than 120Knm) omni antennas B and D will be used. During the other sleep periods (beyond 120Knm) the high gain antenna may be required (in the REACQ mode). The REACQ configuration will provide approximately 210 degrees of HGA coverage per CSM/LM revolution or 35 minutes of MSFN coverage per hour. The REACQ configuration will also allow MCC-H to use real time control to select TLM HBR or LBR and to dump the DSE during each spacecraft revolution.

## 5. Lunar Exploration Phase

- a. Normal CSM communications between MSFN/LM will be by S-Band during the lunar exploration period.
- b. If additional communications capability is required the S-Band erectable antenna will be deployed by the EVA crewman and will be utilized for all LM/MSFN/CSM communications.
- c. During periods when both crewmen are EVA, the „AR“ position (Relay Mode) will be the normal communication mode on each of the Extravehicular Communication System (EVCS). The CDR will relay the LMP VHF voice and data to the LM which in turn will relay to MCC-H via S-Band.

## E. CSM Notes

### 1. Electrical Power System and Water Management

- a. Spacecraft lift-off switch positions are listed in the Apollo Operations Handbook (Volume 2) for CSM 107.
- b. The CSM will remain fully powered up throughout the mission (CMC, IMU and SCS in the „operate“ configuration and optics power-up as required).
- c. Fuel cell H<sub>2</sub> and O<sub>2</sub> purging is scheduled as follows H<sub>2</sub> approximately every 48 hours and O<sub>2</sub> approximately every 12 hours.

- d. The hydrogen and oxygen VAC ION pumps will be inactive throughout the mission.
- e. Potable water will be chlorinated once a day before each sleep period, starting with the First sleep period (GET 13:30). The POT H<sub>2</sub>O inlet valve will be opened prelaunch.
- f. FC purges and waste water dumps will not be scheduled within one hour prior to optical sightings.
- g. Waste H<sub>2</sub>O dumping will be managed to allow:
  - (1) Maximum QTY: 85-90%
  - (2) Minimum QTY: 25%
  - (3) At LOI: QTY = 75%
  - (4) At CM-SM SEP: QTY = 90% to 100%
  - (5) No dumping after MCC3 until after LOI
  - (6) Dumps will be performed (if required) within 2 hours preceding MCC maneuvers
  - (7) In lunar orbit if dumping is required, dumps will be performed immediately prior to sleep periods
  - (8) The water dump will not be operated in the automatic mode at anytime during the mission
- h. The cryogenic heaters will be in AUTO during the mission and the fans will be operated manually. The fans will be cycled for one minute before and after each sleep cycle.
- i. The batteries will be charged according to the following schedule:

<u>Time</u>	<u>Battery</u>
5:20:00	B
12:20:00	A
48:10:00	B
80:25:00	A
103:30:00	B
148:00:00	A
154:00:00	B

2. Environmental Control System and Cabin Pressurization

- a. One CO<sub>2</sub> odor absorber filter (LiOH canister) is changed approximately every 12 hours or if CO<sub>2</sub> partial pressure is greater than 7.6mm Hg. There are 20 filters (2 in the canisters onboard and 18 stowed).
- b. A Pre TLI/LOI ECS redundant component check including the secondary evaporator operation, is performed prior to TLI and LOI. The secondary evaporator water control valves will be turned „OFF“ after the check.
- c. The evaporator operation will be as follows:
  - (1) Launch - primary loop operation
  - (2) Earth Orbit - primary loop operation and secondary loop test plus redundant operation test prior to TLI.
  - (3) Post TLI - deactivate both evaporators
  - (4) Pre LOI-ECS pre TLI/LOI redundant component check and primary evaporator activation
  - (5) Post TEI - deactivate primary evaporator
  - (6) Entry interface minus 1 hour - activate primary and secondary evaporator.

### 3. Guidance and Navigation

- a. During lunar orbit, the CSM and LM will utilize the same landing site REFSMMAT such that the gimballed angles would be 0,0,0 at landing with the LM sitting face forward on landing site number two and the CSM over the landing site pitched up 90° from local horizontal „heads up“.
- b. During PTC the CSM/LM x-axis is pitched up 90° (North) for TLC and down 90° (South) for TEC with the Y-Z axes in the plane of the ecliptic. This change in x-axis pointing is to enable simultaneous viewing of the earth and moon through the side windows while maintaining a favorable high gain antenna position.
- c. The CSM tracking light will be on continuously from undocking to landing and from LM lift-off to docking.

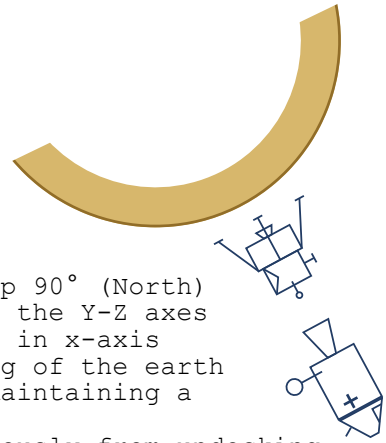

### 4. Landmark Tracking

- The following ground rules were used for landmark tracking.
- a. IMU to be realigned on the dark side preceding each tracking period.
  - b. MSFN is reacquired after each tracking period. The tracking data will be acquired by MSFN after all the marks have been made and while N49 ( $\Delta R, \Delta V$ ) is displayed. MSFN will give a GO when data acquisition has been verified.
  - c. The pseudo landmark tracking (A1) will be used to determine the altitude of an area in which the LM will be making altitude checks after DOI. The data will be processed during the sleep period after the trackings and relayed to the LM prior to undocking.
  - d. In the docked configuration the CSM/LM approaches the landmark in an inertial hold attitude. This inertial attitude places the spacecraft 2° below the local horizontal at the 35° elevation angle point. At 35° elevation angle a pitch down of 0.3°/sec is initiated. Five marks are then taken with the time between marks a minimum of 25 seconds. (See tracking profile)
  - e. In the undocked configuration the CSM approaches the landmark in ORB RATE and pitched down 22° from the local horizontal. At 35° elevation angle five marks are taken with the time between marks a minimum of 25 seconds. ORB RATE is continued throughout the marking period.
  - f. In the undocked COAS tracking the CSM will approach the LM in ORB RATE heads up and pitched down 40° from the local horizontal. When the LM is centered in the COAS the CSM will initiate a 40° variable pitch rate to keep the LM centered in the COAS.

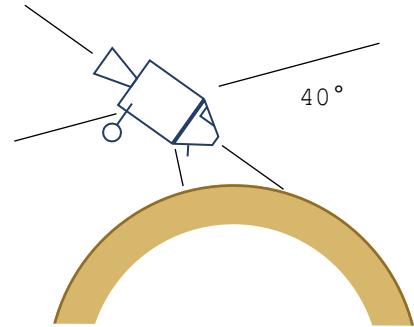
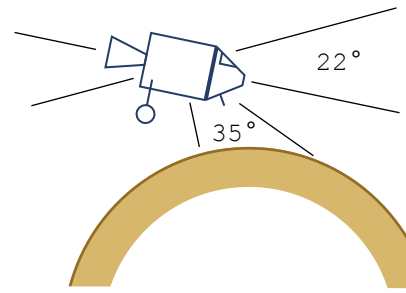
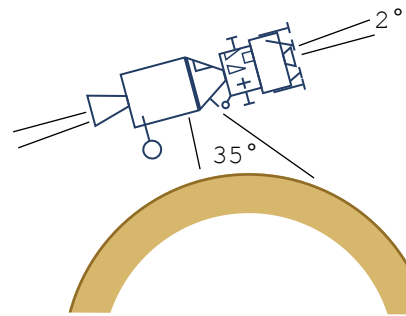

5. CSM/LM and CSM attitude maneuvers will normally be at a rate of  $0.2^\circ/\text{sec}$  or  $0.5^\circ/\text{sec}$ . Unless other rates are required.  
NOTE: At  $0.2^\circ/\text{sec}$ , 15 minutes is required to maneuver  $180^\circ$ .  
At  $0.5^\circ/\text{sec}$ , 6 minutes is required to maneuver  $180^\circ$ .
6. Passive thermal control mode will be initiated after MCC1 or as soon as MCC1 is scrubbed and maintained throughout the mission (except in lunar orbit) until at least three hours before entry except for interruptions for midcourse corrections, communications orientation (maximum interruption of three hours). PTC will not be initiated before approximately 7:00 GET.
7. Service Propulsion System All SPS burns will be initiated on Bank A except LOI1 which will be initiated on Bank B.

#### F. LM Notes

1. Entries into the LM
  - a. Three entries into the LM are scheduled in the timeline at 56:30, 81:30 and 95:52 GET respectively.
  - b. The first entry (56:30 GET) will be for LM familiarization and will be performed by the CDR and LMP in the constant wear garments. During this period there will be approximately 5 minutes of VHF-B LBR data which will be recorded by the DSE in the CSM. The LM will remain on CSM power during the crew familiarization period.
  - c. The second entry (81:30 GET) will be for LM housekeeping and will be performed by the LMP in constant wear garments. During this period the LM will go to internal power for the S-Band/VHF B voice activation.
  - d. The third entry into the LM (95:52 GET) will be performed by the LMP in LCG's to prepare the LM for undocking and descent to the lunar surface. During this period the LMP and CDR initially transfer to the LM in LCG's then return to the CSM for PGA donning.
2. Environmental Control System and Cabin Pressurization
  - a. The LM cabin will contain ambient air at lift off and will bleed down to zero pressure psi during the launch.
  - b. The LM will be pressurized for transposition and docking after which it will be isolated and the pressure periodically monitored.
  - c. The LM will be pressurized prior to the first entry (LM familiarization) after which it will be isolated again for the remainder of the TLC period.
  - d. Prior to the second entry (LM housekeeping) it will be pressurized again and will remain pressurized.
3. Guidance and Navigation
  - a. Two LGC erasable memory dumps and MCC-H verifications will be accomplished prior to DOI. If a significant number of errors are found, memory correction and re-verification will be performed before DOI.
  - b. The LM IMU will be manually aligned to the CSM IMU during the DOI Day LM activation and checkout. P52/AOT alignments will be performed as close to DOI as possible.
  - c. All translations during the undocked manned LM operations will be under PGNCS control.
  - d. The capability for MCC-H to update the LGC via uplink will normally be blocked by the LMP UP-DATA LINK switch (panel 12).
4. RCS Operation and Interface Constraints
  - a. During CSM/LM docked checkout operations, the LM steerable and/or RR antennas will not be powered down once they have been activated. The SM B3 and C4 thrusters will be deactivated before the LM steerable and/or RR antennas have been unstowed in order to prevent SM-RCS impingement on these antennas.



- b. The CSM roll jets and LM yaw jets will be disabled when the probe is preloaded (docking latches are cocked) and the tunnel is pressurized prior to undocking. The jets will be activated after tunnel venting.
- c. LM RCS two jet ullage (System B) will be used for unstaged ullage maneuvers in order to prevent asymmetrical RCS thrust caused by impingement on the descent stage.
- d. The RCS interconnect will be used during the APS lift-off and ascent, but will not be used during the rendezvous maneuvers.

5. Rendezvous

- a. The rendezvous radar will be pointed away from the sun and will be turned off when no functional use is required to prevent overheating of the antenna.
- b. The LM tracking light will be on continuously between separation and touchdown and between launch and docking except during PGNC/AOT alignments. During PGNC/AOT alignments (LM P52), the tracking light would interfere with the alignments. (dark adaption)

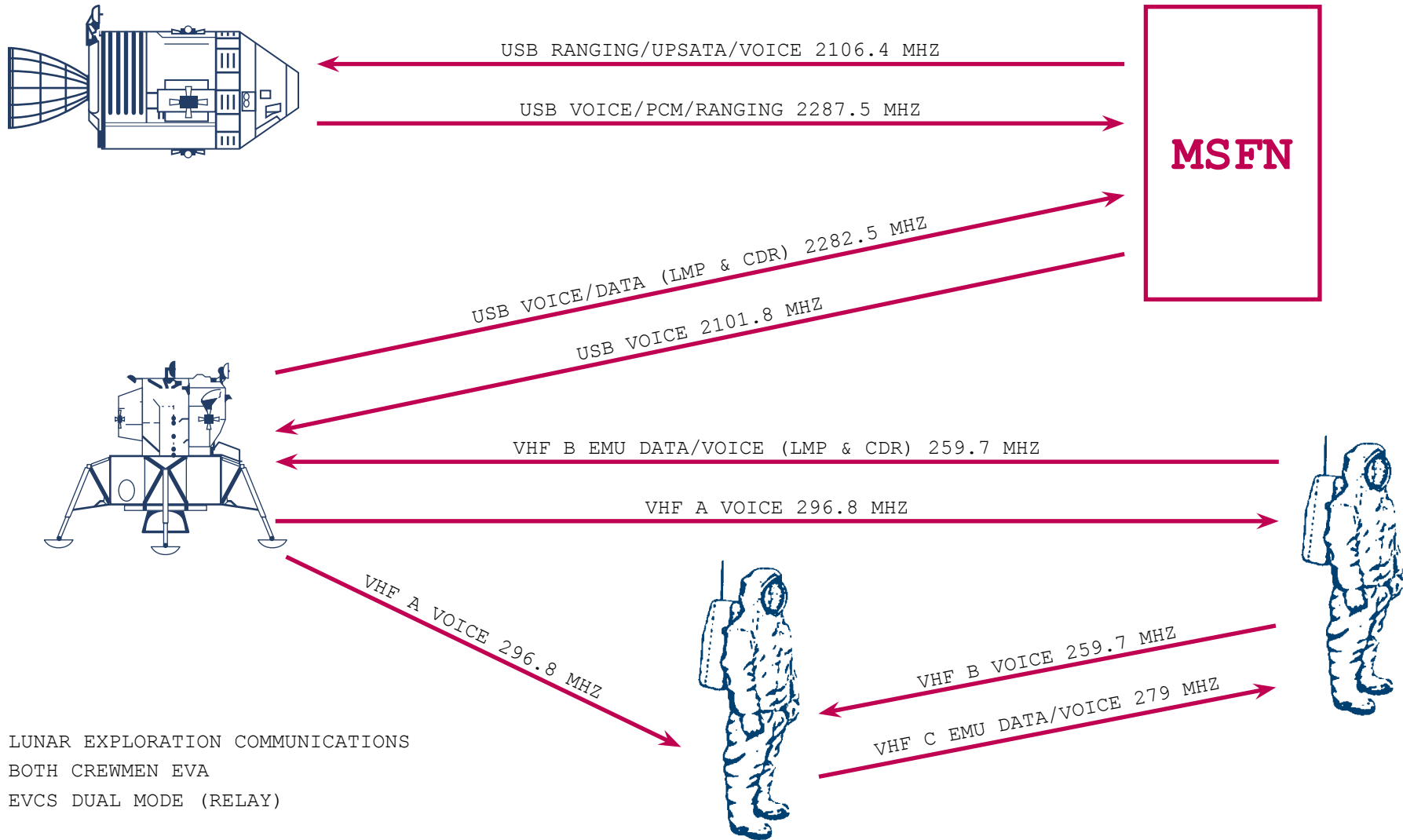

LUNAR EXPLORATION COMMUNICATIONS  
 BOTH CREWMEN EVA  
 EVCS DUAL MODE (RELAY)

FIGURE 1-4

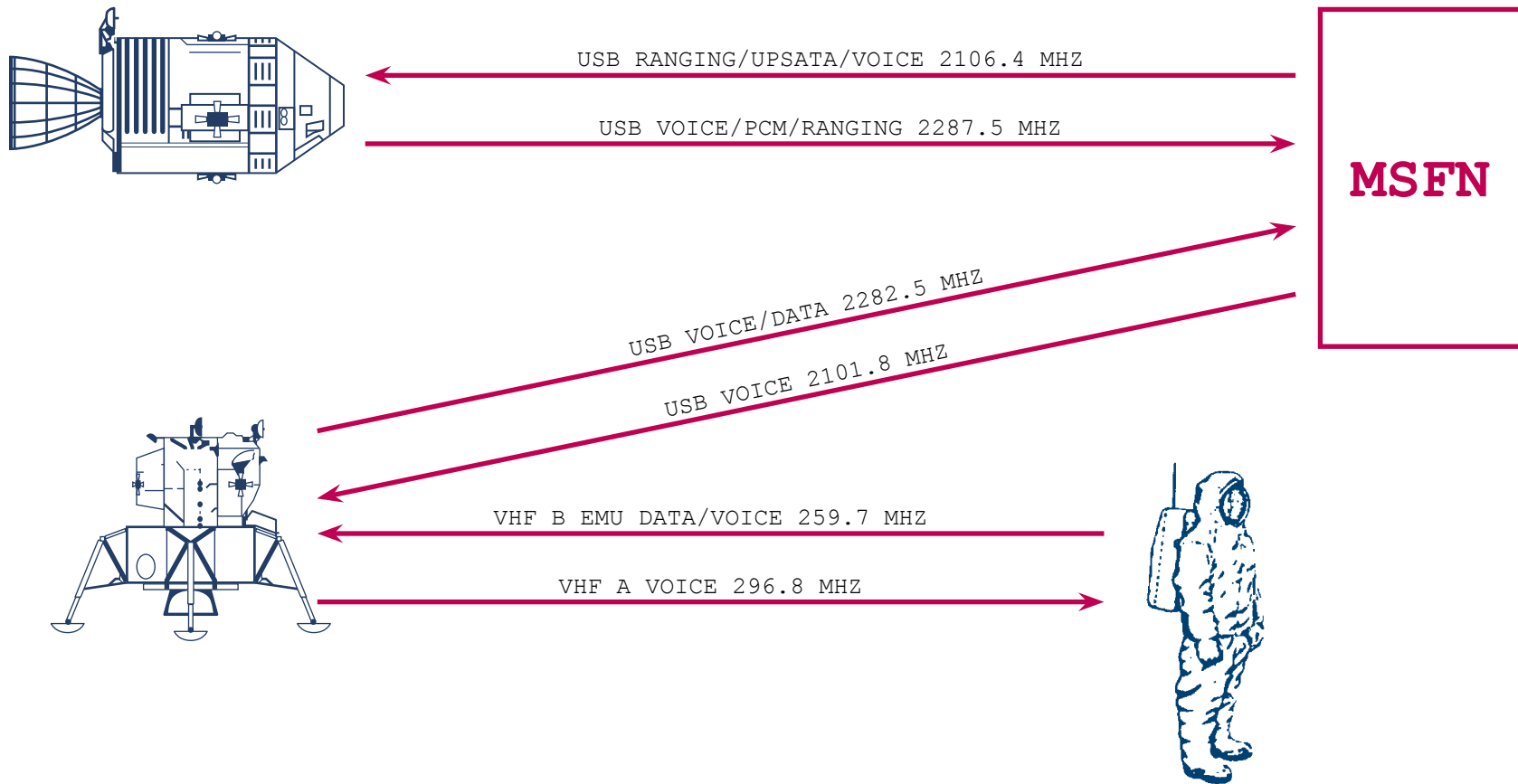

1 - 21

LUNAR EXPLORATION COMMUNICATIONS  
 ONE CREWMEN EVA  
 PRIMARY MODE

FIGURE 1-5



SECTION II

**UPDATE FORMS**



## UPDATE FORMS

This section contains the update pads which are in the Flight Data File onboard the spacecraft.

The CSM forms are as follows:

1. TLI Maneuver
2. P37 Block Data
3. P27 Update
4. P30 Maneuver (External  $\Delta V$ )
5. P76
6. CSM Rendezvous Rescue
7. Lunar Entry
8. Earth Orbit Entry
9. Earth Orbit Block Data

The LM forms are:

1. P27 Update
2. AGS State Vector Update
3. Phasing P30 LM Maneuver
4. P30 LM Maneuver
5. DOI Data
6. PDI Data
7. Lunar Surface
8. LM Ascent
9. CSI Data
10. CDH Data
11. TPI Data

TLI	TLI											TLI
	X	•		•		X	•		•		TB6p	
APRIL 1, 1969	X	X	X			X	X	X			R	TLI
	X	X	X			X	X	X			P	
	X	X	X			X	X	X			Y	
	X	X	X	•		X	X	X	•		BT	
					•					•	$\Delta VC'$	
											VI	
	X	X	X			X	X	X			R	SEP
	X	X	X			X	X	X			P	
	X	X	X			X	X	X			Y	
	X					X	X	X			R	EXTRACTION
	X					X	X	X			P	
	X					X	X	X			Y	



TLI PAD

TB 6p	X:XX:XX (HR:MIN:SEC)	PREDICTED TIME OF BEGINNING OF S-IVB RESTART PREPARATION FOR TLI (TB6 = TLI IGN -578.6 SEC)
R	XXX (DEG)	PREDICTED SPACECRAFT IMU GIMBAL
P	XXX (DEG)	ANGLES AT TLI IGNITION
Y	XXX (DEG)	
BT	X:XX (MIN:SEC)	DURATION OF TLI BURN
$\Delta$ VC	XXXX.X (FPS)	NOMINAL TLI $\Delta$ V SET INTO EMS $\Delta$ V COUNTER
VI	+XXXXXX (FPS)	NOMINAL INERTIAL VELOCITY DISPLAYED ON DSKY AT TLI CUTOFF
R SEP	XXX (DEG)	PREDICTED SPACECRAFT IMU GIMBAL
P SEP	XXX (DEG)	ANGLES AT COMPLETION OF S-IVB
Y SEP	XXX (DEG)	MNVR TO CSM/S-IVB SEP ATTITUDE
R EXT	XXX (DEG)	PREDICTED SPACECRAFT IMU
P EXT	XXX (DEG)	GIMBAL ANGLES AT TIME OF CSM
Y EXT	XXX (DEG)	EXTRACTION OF LM FROM S-IVB

		P37 BLOCK DATA													
				•				•					GETI		
		X						X					$\Delta$ VT		
		X	<input type="checkbox"/>					X	<input type="checkbox"/>						LONG
				•				•							GET <sub>400K</sub>
				•				•							GETI
		X						X							$\Delta$ VT
		X	<input type="checkbox"/>					X	<input type="checkbox"/>						LONG
				•				•							GET <sub>400K</sub>
				•				•							GETI
		X						X							$\Delta$ VT
		X	<input type="checkbox"/>					X	<input type="checkbox"/>						LONG
				•				•							GET <sub>400K</sub>
P37				•				•					GETI	P37	
		X						X					$\Delta$ VT		
		X	<input type="checkbox"/>					X	<input type="checkbox"/>						LONG
				•				•							GET <sub>400K</sub>
				•				•							GETI
		X						X							$\Delta$ VT
		X	<input type="checkbox"/>					X	<input type="checkbox"/>						LONG
				•				•							GET <sub>400K</sub>
				•				•							GETI
		X						X							$\Delta$ VT
		X	<input type="checkbox"/>					X	<input type="checkbox"/>						LONG
				•				•							GET <sub>400K</sub>
APRIL 1, 1969				•				•					GETI		
		X						X					$\Delta$ VT		
		X	<input type="checkbox"/>					X	<input type="checkbox"/>						LONG
				•				•							GET <sub>400K</sub>
				•				•							GETI
		X						X							$\Delta$ VT
		X	<input type="checkbox"/>					X	<input type="checkbox"/>						LONG
				•				•							GET <sub>400K</sub>
				•				•							GETI
		X						X							$\Delta$ VT
		X	<input type="checkbox"/>					X	<input type="checkbox"/>						LONG
				•				•							GET <sub>400K</sub>

P37 BLOCK DATA

GETI	XXX:XX (HR:MIN)	DESIRED TIME OF IGNITION
$\Delta$ VT	XXXX (FPS)	TOTAL VELOCITY OF MNVR
LONG	$\pm$ XXX (DEG)	LONGITUDE OF THE LANDING POINT FOR ENTRY GUIDANCE
GET 400K	XXX:XX (HR:MIN)	TIME OF ENTRY INTERFACE



P27 UPDATE - CSM

PURP	XXX	TYPE OF DATA TO BE RECEIVED (SUCH AS: CMC TIME)
V	XX (VERB)	TYPE OF COMMAND LOAD (70-71-72-73)
GET	XXX:XX:XX (HR:MIN:SEC)	TIME DATA RECORDED
304 01	XX (OCTAL)	INDEX NO. OF COMMAND WORDS IN LOAD
02-24	XX (OCTAL)	CORRECTION IDENTIFIERS
N34 NAV CHECK	XXX:XX:XX.XX (HR:MIN:SEC)	TIME FOR CONFIRMATION OF GROUNDTRACK
N43		
LAT	XX.XX (DEG)	LATITUDE FOR GROUND TRACK CONFIRMATION
LONG	XXX.XX (DEG)	LONGITUDE FOR GROUND TRACK CONFIRMATION
ALT	XXX.X (DEG)	ALTITUDE FOR GROUND TRACK CONFIRMATION

		P30 MANEUVER						
								PURPOSE
	SET STARS			/				PROP/GUID
		+						WT N47
P30	RALIGN _____		0	0		•		P <sub>TRIM</sub> N48
	PALIGN _____		0	0		•		Y <sub>TRIM</sub>
	YALIGN _____	+	0	0				HRS GETI
		+	0	0	0			MIN N33
		+	0			•		SEC
	ULLAGE _____					•		$\Delta V_X$ N81
	_____					•		$\Delta V_Y$
	_____					•		$\Delta V_Z$
	_____	X	X	X				R
	_____	X	X	X				P
	_____	X	X	X				Y
		+				•		H <sub>A</sub> N42
						•		H <sub>P</sub>
		+				•		$\Delta VT$
	HORIZON/WINDOW _____	X	X	X		•		BT
	_____	X				•		$\Delta VC$
	_____	X	X	X	X			SXTS
	_____	+				•	0	SFT
		+			•	0	0	TRN
		X	X	X				BSS
		X	X			•		SPA
		X	X	X		•		SXP
	OTHER _____		0			•		LAT N61
	_____					•		LONG
	_____	+				•		RTGO EMS
		+						VIO
				•		•		GET 0.05G

P30 MANEUVER

PURPOSE	XXXXX	TYPE OF MNVR TO BE PERFORMED
PROP/GUID	XXX/XXX	PROPULSION SYSTEM (SPS/RCS) GUIDANCE (SCS/G&N)
WT	+XXXXX (lbs)	PREMANEUVER VEHICLE WEIGHT
P TRIM	±X.XX (DEG)	SPS PITCH GIMBAL OFFSET TO PLACE THRUST THROUGH THE CG
Y TRIM	±X.XX (DEG)	SPS YAW GIMBAL OFFSET TO PLACE THRUST THROUGH THE CG
GETI	XX:XX:XX.XX (HRS:MIN:SEC)	TIME OF MNVR IGNITION
$\Delta V_X$	±XXXX.X (FPS)	P30 VELOCITY TO BE GAINED COMPONENTS IN LOCAL VERTICAL COORDINATES
$\Delta V_Y$	±XXXX.X (FPS)	
$\Delta V_Z$	±XXXX.X (FPS)	
R	XXX (DEG)	IMU GIMBAL ANGLES OF MANEUVER ATTITUDE
P	XXX (DEG)	
Y	XXX (DEG)	
HA	XXXX.X (NM)	PREDICTED APOGEE ALTITUDE AFTER MANEUVER
HP	±XXXX.X (NM)	PREDICTED PERIGEE ALTITUDE AFTER MANEUVER
$\Delta VT$	+XXXX.X (FPS)	TOTAL VELOCITY OF MANEUVER
BT	X:XX (MIN:SEC)	MANEUVER DURATION
$\Delta VC$	XXXX.X (FPS)	PREMANEUVER $\Delta V$ SETTING IN EMS $\Delta V$ COUNTER
SXTS	XX (OCTAL)	SEXTANT STAR FOR MANEUVER ATTITUDE CK
SFT	+XXX.X (DEG)	SEXTANT SHAFT SETTING FOR MANEUVER ATTITUDE CK
TRN	+XX.X (DEG)	SEXTANT TRUNNION SETTING FOR MANEUVER ATTITUDE CK
BSS	XX (OCTAL)	BORESIGHT STAR FOR MANEUVER ATTITUDE CK USING THE COAS
SPA	±XX.X (DEG)	BSS PITCH ANGLE ON COAS FOR MANEUVER ATTITUDE CK

SXP	±X.X (DEG)	BSS X POSITION ON COAS FOR MANEUVER ATTITUDE CK
LAT LONG	±XX.XX (DEG) ±XXX.XX (DEG)	LATITUDE AND LONGITUDE OF THE LANDING POINT FOR ENTRY GUIDANCE
RTGO	+XXXX.X (NM)	RANGE TO GO FOR EMS INITIALIZATION
VI0	+XXXXX (FPS)	INERTIAL VELOCITY AT .05G FOR EMS INITIALIZATION
GET (.05G)	XXX:XX:XX.XX (HRS:MIN:SEC)	TIME OF .05G
SET STARS	XX (OCTAL) XX (OCTAL)	STARS FOR BACKUP GDC ALIGN
R, P, Y (ALIGN)	XXX (DEG) XXX (DEG) XXX (DEG)	ATTITUDE TO BE SET IN ATTITUDE SET TW FOR BACKUP GDC ALIGN
ULLAGE	X (JETS) XX.X (SEC)	NO. OF SM RCS JETS USED AND LENGTH OF TIME OF ULLAGE
HORIZON/WINDOW	XX.X (DEG)	WINDOW MARKING AT WHICH HORIZON IS PLACED AT A SPECIFIED TIG (ATT CK)
OTHER		ADDITIONAL REMARKS VOICED UP BY MCC-H



THIS PAGE INTENTIONALLY LEFT BLANK.

P76 UPDATE PAD															
P76												PURPOSE			
		+	0	0					+	0	0	HR	N33		
		+	0	0	0				+	0	0	0	MIN	TIG	
		+	0			•			+	0			•	SEC	
							•						•	$\Delta$ VX	N84
							•						•	$\Delta$ VY	
							•						•	$\Delta$ VZ	
														PURPOSE	
		+	0	0					+	0	0			HR	N33
		+	0	0	0				+	0	0	0		MIN	TIG
		+	0			•			+	0			•	SEC	
	APRIL 5, 1969						•						•	$\Delta$ VX	N84
						•						•	$\Delta$ VY		
						•						•	$\Delta$ VZ		
														PURPOSE	
		+	0	0					+	0	0			HR	N33
		+	0	0	0				+	0	0	0		MIN	TIG
		+	0			•			+	0			•	SEC	
							•						•	$\Delta$ VX	N84
							•						•	$\Delta$ VY	
							•						•	$\Delta$ VZ	
														PURPOSE	
		+	0	0					+	0	0			HR	N33
	+	0	0	0				+	0	0	0		MIN	TIG	
	+	0			•			+	0			•	SEC		
						•						•	$\Delta$ VX	N84	
						•						•	$\Delta$ VY		
						•						•	$\Delta$ VZ		
													PURPOSE		
	+	0	0					+	0	0			HR	N33	
	+	0	0	0				+	0	0	0		MIN	TIG	
	+	0			•			+	0			•	SEC		
						•						•	$\Delta$ VX	N84	
						•						•	$\Delta$ VY		
						•						•	$\Delta$ VZ		
													PURPOSE		

P76 UPDATE PAD

PURPOSE  
N33 TIG

XXXXX  
XX:XX:XX.XX  
(HR:MIN:SEC)

PURPOSE OF MANEUVER  
TIME OF IGNITION

N84  
 $\Delta V_X$   
 $\Delta V_Y$   
 $\Delta V_Z$

XXXX.X (FPS)  
XXXX.X (FPS)  
XXXX.X (FPS)

COMPONENTS OF  $\Delta V$  APPLIED ALONG  
LOCAL VERTICAL AXIS AT TIG (LM)

### CSM RENDEVOUS RESCUE PADS

CSM SEP PAD

31	00	000	0.
81	+ 0000.0	+ 0000.0	- 0002.5
22	XXX	XXX	XXX

DOI PAD

84	.	.	.
33	.	.	.

PDI<sub>1</sub> +12 ABORT PAD

84	.	.	.
33	.	.	.

„CSM RESCUE“ PAD

PHAS	33	00	000	0.
TPI (PDI < 10)	37	00	000	0.
TPI (PDI > 10)	37	00	000	0.

„CSM RESCUE UPDATE“ PAD

PHAS	33	00	000	0.
TPI (PDI < 14.5)	37	00	000	0.
TPI (T <sub>2</sub> )	37	00	000	0.

RESCUE TWO PAD

47	+	.	+	0000.0	
48		.		.	
33	00	000	0.		
81	.	.	.		
22	XXX	XXX	XXX		
$\Delta V_C$	X	.			
11	00	000	0.		
37	00	000	0.		
N					

CSI ONE

11		000	0.
81	.	.	.
N			

P22 PAD

T1	.	.	.	(HOR)
T2	.	.	.	(LMK)
	.	NM (N OR S)		
89	.	.	.	
	LAT	LONG/2	ALT	

NOMINAL LM IGNITION TIMES

CSI	11	00	000	0.
PC	33	00	000	0.
TPI	37	00	000	0.

CSI TWO

11	00	000	0.
81	.	.	.
N			

CSI THREE

11	00	000	0.
81	.	.	.
N			

CSI FOUR

11	00	000	0.
81	.	.	.
N			

CDH

13	00	000	0.
81	.	.	.

TPI

13	00	000	0.
81	.	.	.
59	.	.	.
LOS BT	XX	XX	XX

CSM SEP PAD

33	GETI	XXX:XX:XX.XX (HRS:MIN:SEC)	GET OF CSM/LM SEPARATION BURN
81	DELTA VX DELTA VY DELTA VZ	+XXXX.X (FPS) +XXXX.X (FPS) +XXXX.X (FPS)	LOCAL VERTICAL VELOCITY COMPONENTS OF SEP BURN
22	R P Y	XXX (DEG) XXX (DEG) XXX (DEG)	SEPARATION BURN INERTIAL GIMBAL ANGLES

DOI PAD

84	DELTA VX DELTA VY DELTA VZ	XXXX.X (FPS) XXXX.X (FPS) XXXX.X (FPS)	LM LOCAL VERTICAL VELOCITY COMPONENTS FOR DOI BURN
33	GETI	XXX:XX:XX.XX (HRS:MIN:SEC)	GET OF DOI BURN

PDI +12 ABORT PAD

84	DELTA VX DELTA VY DELTA VZ	XXXX.X (FPS) XXXX.X (FPS) XXXX.X (FPS)	LM LOCAL VERTICAL VELOCITY COMPONENTS FOR FIRST OPPORTUNITY PDI PLUS 12 MIN ABORT
33	GETI	XXX:XX:XX.XX (HRS:MIN:SEC)	GET OF PDI +12 MIN ABORT BURN

„CSM RESCUE“ PAD

PHAS	33	GETI	XXX:XX:XX.XX (HRS:MIN:SEC)	GET OF CSM ABORT PHASING BURN
TPI (PDI 10)	37	GETI	XXX:XX:XX.XX (HRS:MIN:SEC)	GET OF TPI FOR LM ABORTS BETWEEN PDI AND PDI +10 MIN
TPI (PDI 10)	37	GETI	XXX:XX:XX.XX (HRS:MIN:SEC)	GET OF TPI FOR LM ABORTS AFTER PDI +10 MIN

„CSM RESCUE UPDATE“ PAD

PHAS	33	GETI	XXX:XX:XX.XX (HRS:MIN:SEC)	GET OF CSM ABORT PHASING BURN FOR 2ND OPPORTUNITY (1 REV DELAY)
TPI (PDI 14.5)	37	GETI	XXX:XX:XX.XX (HRS:MIN:SEC)	GET OF TPI FOR LM ABORTS BETWEEN PDI AND PDI +14.5 MIN FOR 2ND OPPORTUNITY
TPI (T2)	37	GETI	XXX:XX:XX.XX (HRS:MIN:SEC)	GET OF PREFERRED LM LIFTOFF TIME

RESCUE TWO PAD

47	WT	XXXX.X (lbs)	PREMANEUVER CSM WEIGHT
48	P TRIM Y TRIM	X.XX (DEG) X.XX (DEG)	SPS PITCH & YAW GIMBAL OFFSET TO PLACE THRUST THROUGH THE CG
33	GETI	XXX:XX:XX.XX (HRS:MIN:SEC)	GET OF RESCUE BURN
81	DELTA VX DELTA VY DELTA VZ	XXXX.X (FPS) XXXX.X (FPS) XXXX.X (FPS)	LOCAL VERTICAL VELOCITY COMPONENTS OF RESCUE BURN
22	R P Y	XXX (DEG) XXX (DEG) XXX (DEG)	RESCUE BURN GIMBAL ANGLES
$\Delta V_c$	$\Delta V_c$	XX.X (FPS)	VELOCITY TO BE SET IN EMS COUNTER FOR RESCUE BURN
11	GETI	XXX:XX:XX.XX (HRS:MIN:SEC)	GET OF CSI BURN BASED ON RESCUE BURN
37	GETI	XXX:XX:XX.XX (HRS:MIN:SEC)	GET OF TPI BURN BASED ON RESCUE BURN
N		X	THE FUTURE APSIDAL CROSSING (APOLUNE OR PERILUNE) OF THE ACTIVE VEHICLE AT WHICH CDH SHOULD OCCUR

CSI ONE

11	GETI	XXX:XX:XX.XX (HRS:MIN:SEC)	GET OF CSI ONE BURN
81	DELTA VX DELTA VY DELTA VZ	XXXX.X (FPS) XXXX.X (FPS) XXXX.X (FPS)	LOCAL VERTICAL VELOCITY COMPONENTS OF CSI ONE BURN
N		X	THE FUTURE APSIDAL CROSSING (APOLUNE OR PERILUNE) OF THE ACTIVE VEHICLE AT WHICH CDH SHOULD OCCUR

CSI TWO, THREE, FOUR

SAME AS ABOVE EXCEPT CSI TWO, THREE, FOUR

CDH

13	GETI	XXX:XX:XX.XX (HRS:MIN:SEC)	GET OF CDH BURN
81	DELTA VX DELTA VY DELTA VZ	XXXX.X (FPS) XXXX.X (FPS) XXXX.X (FPS)	LOCAL VERTICAL VELOCITY COMPONENTS OF CDH BURN

TPI

37	GETI	XXX:XX:XX.XX (HRS:MIN:SEC)	GET OF LM TPI BURN
81	DELTA VX DELTA VY DELTA VZ	XXXX (FPS) XXXX (FPS) XXXX (FPS)	LOCAL VERTICAL VELOCITY COMPONENTS OF TPI BURN
59	ΔV (LOS)	XXXX (FPS)	VELOCITY COMPONENTS ALONG THE LINE OF SIGHT TO TARGET
LOS BT		X:XX MIN:SEC	BURN DURATION ALONG THE LINE OF SIGHT

P22 PAD

T1		XXX:XX:XX.XX (HRS:MIN:SEC)	GET AT WHICH LANDMARK APPEARS ON HORIZON
T2		XXX:XX:XX.XX (HRS:MIN:SEC)	GET AT WHICH LANDMARK LOS IS 35° ABOVE LOCAL HORIZONTAL
NM (N OR S)		XX.X (NM)	DISTANCE OF LANDMARK NORTH OR SOUTH OF ORBITAL TRACK
89	LAT LONG ALT	±XX.X (DEG) ±XX (DEG)	LATITUDE OF LANDMARK LONGITUDE OF LANDMARK ALTITUDE OF LANDMARK ABOVE OR BELOW MEAN LUNAR RADIUS

NOMINAL LM IGNITION TIMES

CSI 11	GETI	XXX:XX:XX.XX (HRS:MIN:SEC)	NOMINAL GET OF LM CSI BURN
PC 33	GETI	XXX:XX:XX.XX (HRS:MIN:SEC)	NOMINAL GET OF LM PLANE CHANGE BURN
TPI 37	GETI	XXX:XX:XX.XX (HRS:MIN:SEC)	NOMINAL GET OF LM TPI BURN



THIS PAGE INTENTIONALLY LEFT BLANK.

		LUNAR ENTRY																		
																				AREA
		X	X	X										X	X	X				R 0.05G
		X	X	X										X	X	X				P 0.05G
		X	X	X										X	X	X				Y 0.05G
				•		•										•		•		GET HOR
		X	X	X										X	X	X				P CK
			0			•									0			•		LAT N61
						•												•		LONG
		X	X	X									•	X	X	X			•	MAX G
		+												+						V <sub>400K</sub> N60
		-	0	0										-	0	0			•	γ 400K
		+											•	+					•	RTGO EMS
		+												+						VIO
				•		•										•		•		RRT
X	X			•								X	X			•		RET 0.05G		
+	0	0		•								+	0	0		•		D <sub>L</sub> MAX N69		
+	0	0		•								+	0	0		•		D <sub>L</sub> MIN		
+												+						V <sub>L</sub> MAX		
+												+						V <sub>L</sub> MIN		
X	X	X		•								X	X	X		•		DO		
X	X			•								X	X			•		RET V <sub>CIRC</sub>		
X	X			•								X	X			•		RETBBO		
X	X			•								X	X			•		RETEBO		
X	X			•								X	X			•		RETDRO		
X	X	X	X									X	X	X	X			SXTS		
+				•							0	+				•		SFT		
+			•		0	0						+			•		0	TRN		
X	X	X										X	X	X				BSS		
X	X										•	X	X				•	SPA		
X	X	X									•	X	X	X			•	SXP		
X	X	X	X									X	X	X	X			LIFT VECTOR		

LUNAR ENTRY

APRIL 5, 1969

LUNAR ENTRY

LUNAR ENTRY PAD

AREA	XXXXX	SPLASHDOWN AREA DEFINED BY TARGET LINE
R .05G	XXX (DEG)	SPACECRAFT IMU GIMBAL ANGLES
P .05G	XXX (DEG)	REQUIRED FOR AERODYNAMIC TRIM
Y .05G	XXX (DEG)	AT .05G
GET (HOR CK)	XXX:XX:XX (HRS:MIN:SEC)	TIME OF ENTRY ATTITUDE HORIZ CHECK AT EI -17 MIN.
P (HOR CK)	XXX (DEG)	PITCH ATTITUDE FOR HORIZON CHECK AT EI -17 MIN.
LAT	±XX.XX (DEG)	LATITUDE OF TARGET POINT
LONG	±XXX.XX (DEG)	LONGITUDE OF TARGET POINT
MAX G	XX.X (G`s)	PREDICTED MAXIMUM REENTRY ACCELERATION
V400K	+XXXXX (FPS)	INERTIAL VELOCITY AT ENTRY INTERFACE
γ400K	-X.XX (DEG)	INERTIAL FLIGHT PATH ANGLE AT ENTRY INTERFACE
RTGO	+XXXX.X (NM)	RANGE TO GO FROM .05G TO TARGET FOR EMS INITIALIZATION
VI0	+XXXXX (fps)	INERTIAL VELOCITY AT .05G FOR EMS INITIALIZATION
RRT	XXX:XX:XX (HRS:MIN:SEC)	REENTRY REFERENCE TIME BASED ON GET OF PREDICTED 400K (GET START)
RET .05G	XX:XX (MIN:SEC)	TIME OF .05G FROM 400K (RRT)
DL MAX	+X.XX (G`s)	MAXIMUM ACCEPTABLE VALUE OF PREDICTED DRAG LEVEL (FROM CMC)
DL MIN	+X.XX (G`s)	MINIMUM ACCEPTABLE VALUE OF PREDICTED DRAG LEVEL (FROM CMC)
VL MAX	+XXXXX (FPS)	MAXIMUM ACCEPTABLE VALUE OF EXIT VELOCITY (FROM CMC)
VL MIN	+XXXXX (FPS)	MINIMUM ACCEPTABLE VALUE OF EXIT VELOCITY (FROM CMC)
DO	X.XX (G`s)	PLANNED DRAG LEVEL DURING CONSTANT G
RET VCIRC	XX:XX (MIN:SEC)	TIME FROM EI THAT S/C VELOCITY BECOMES CIRCULAR
RETBBO	XX:XX (MIN:SEC)	TIME FROM EI TO THE BEGINNING OF BLACKOUT
RETEBO	XX:XX (MIN:SEC)	TIME FROM EI TO THE END OF BLACKOUT

RETDRO	XX:XX (MIN:SEC)	TIME FROM EI TO DROGUE DEPLOY
SXTS	XX (OCTAL)	SEXTANT STAR FOR ENTRY ATTITUDE CHECK
SFT	+XXX. X (DEG)	SEXTANT SHAFT SETTING FOR ENTRY ATTITUDE CHECK
TRN	+XX. X (DEG)	SEXTANT TRUNNION SETTING FOR ENTRY ATTITUDE CHECK
BSS	XXX (OCTAL)	BORESIGHT STAR FOR ENTRY ATTITUDE CHECK USING THE COAS
SPA	±XX.X (DEG)	BSS PITCH ANGLE ON COAS FOR ENTRY ATTITUDE CHECK
SXP	±X.X (DEG)	BSS X POSITION ON COAS FOR ENTRY ATTITUDE CHECK
LIFT VECTOR	XX (UP/DN)	LIFT VECTOR DESIRED AT .05G's BASED ON ENTRY CORRIDOR

THIS PAGE INTENTIONALLY LEFT BLANK.

EARTH ORBIT ENTRY UPDATE											
APRIL 16, 1969	X			-		X			-		AREA
	X	X	-		•	X	X	-		•	ΔV TO
	X	X	X			X	X	X			R 0.05G EMS
	X	X	X			X	X	X			P 0.05G
	X	X	X			X	X	X			Y 0.05G
	+				•	+				•	RTGO EMS
	+					+					VIO
	X	X		•		X	X		•		RET 0.05G
		0		•			0		•		LAT N61
				•					•		LONG
	X	X		•		X	X		•		RET 0.2G
				•					•		DRE (55°) N66
	R	R		/		R	R		/		BANK AN
	X	X		•		X	X		•		RET RB
	X	X		•		X	X		•		RETBBO
	X	X		•		X	X		•		RETEBO
	X	X		•		X	X		•		RETDROG
	X	X	X			X	X	X			(90°/fps) CHART
	X	X				X	X				DRE (90°) UPDATE
	POST BURN										
X	X	X			X	X	X			P 0.05G	
+				•	+				•	RTGO EMS	
+					+					VIO	
X	X		•		X	X		•		RET 0.05G	
X	X		•		X	X		•		RET 0.2G	
			•					•		DRE ±100nm N66	
R	R		/		R	R		/		BANK AN	
X	X		•		X	X		•		RETRB	
X	X		•		X	X		•		RETBBO	
X	X		•		X	X		•		RETEBO	
X	X		•		X	X		•		RETDROG TO MAIN	
E.O. ENTRY											E.O. ENTRY

EARTH ORBIT ENTRY UPDATE

AREA	XXX-X	RECOVERY AREA - FIRST 3 DIGITS DENOTES REV IN WHICH LANDING OCCURS. LAST DIGIT DENOTES RECOVERY AREA AND SUPPORT CAPABILITIES.
$\Delta V$ TO	XX.X (FPS)	$\Delta V$ DUE TO ENGINE TAILOFF
EMS		
R 0.05G	XXX (DEG)	SPACECRAFT IMU GIMBAL ANGLES REQUIRED FOR AERODYNAMIC TRIM AT 0.05G.
P 0.05G	XXX (DEG)	
Y 0.05G	XXX (DEG)	
EMS		
RTGO	XXXX.X (NM)	RANGE TO GO FROM .05G TO TARGET
VI0	XXXXX (FPS)	INERTIAL VELOCITY AT .05G FOR EMS INITIALIZATION
RET 0.05G	XX:XX (MIN:SEC)	TIME FROM RETROFIRE TO .05G
N61		
LAT	$\pm$ XX.XX (DEG)	LATITUDE OF IMPACT LANDING POINT
LONG	$\pm$ XXX.XX (DEG)	LONGITUDE OF IMPACT LANDING POINT
N66		
RET .2G	XX:XX (MIN:SEC)	TIME FROM RETROFIRE TO .2G
DRE (55°)	$\pm$ XXXX.X (NM)	DOWNRANGE ERROR AT .2G
BANK AN	XX/XX (DEG/DEG)	BACKUP BANK ANGLE FOR SCS ENTRY: ROLL RIGHT/ROLL LEFT
RETRB	XX:XX (MIN:SEC)	TIME FROM RETROFIRE TO REVERSE BACKUP BANK ANGLE
RETBBO	XX:XX (MIN:SEC)	TIME FROM RETROFIRE TO BEGINNING OF COMMUNICATIONS BLACKOUT
RETEBO	XX:XX (MIN:SEC)	TIME FROM RETROFIRE TO END OF COMMUNICATIONS BLACKOUT
RETDROG	XX:XX (MIN:SEC)	TIME FROM RETROFIRE TO DROGUE CHUTE DEPLOYMENT
CHART UPDATE		
90°/FPS	$\pm$ XX	VALUES USED TO RE-PLOT BACKUP ENTRY CHART - $\Delta V$ AND DOWNRANGE ERROR (DRE) @ 90° BANK ANGLE
DRE (90°)	$\pm$ XXX	

POST BURN

P 0.05G	XXX (DEG)	PITCH ANGLE @ ENTRY INTERFACE
EMS		
RTGO	+XXXX.X (NM)	RANGE TO GO FROM 0.05G TO TARGET FOR EMS COUNTER
VI0	+XXXXX (FPS)	INERTIAL VELOCITY @ 0.05G
RET 0.05G	XX:XX (MIN:SEC)	TIME FROM RETROFIRE TO 0.05G
RET 0.2G	XX:XX (MIN:SEC)	TIME FROM RETROFIRE TO 0.2G
DRE	±XXXX.X (NM)	DOWN RANGE ERROR
BANK AN	XX/XX (DEG/DEG)	BACKUP BANK ANGLE FOR SCS ENTRY: ROLL RIGHT/ROLL LEFT
RETRB	XX:XX (MIN:SEC)	TIME FROM RETROFIRE TO REVERSE BACKUP BANK ANGLE
RETBBO	XX:XX (MIN:SEC)	TIME FROM RETROFIRE TO BEGINNING OF COMMUNICATIONS BLACKOUT
RETEBO	XX:XX (MIN:SEC)	TIME FROM RETROFIRE TO END OF COMMUNICATIONS BLACKOUT
RETDROG	XX:XX (MIN:SEC)	TIME FROM RETROFIRE TO DROGUE CHUTE DEPLOYMENT





		EARTH ORBIT BLOCK DATA												
		X	X			-		X	X					-
APRIL 1, 1969	E.O. BLOCK	X	X					X	X					AREA
		X	X	X			•	X	X	X			•	LAT
		X	X				•	X	X				•	LONG
				•		•				•		•		GETI
		X	X	X			•	X	X	X			•	$\Delta V_C$
		X	X				-	X	X				-	AREA
		X	X	X			•	X	X	X			•	LAT
		X	X				•	X	X				•	LONG
				•		•				•		•		GETI
		X	X	X			•	X	X	X			•	$\Delta V_C$
		X	X				-	X	X				-	AREA
		X	X	X			•	X	X	X			•	LAT
		X	X				•	X	X				•	LONG
				•		•				•		•		GETI
		X	X	X			•	X	X	X			•	$\Delta V_C$
		X	X				-	X	X				-	AREA
X	X	X			•	X	X	X			•	LAT		
X	X				•	X	X				•	LONG		
		•		•				•		•		GETI		
X	X	X			•	X	X	X			•	$\Delta V_C$		
X	X				-	X	X				-	AREA		
X	X	X			•	X	X	X			•	LAT		
X	X				•	X	X				•	LONG		
		•		•				•		•		GETI		
X	X	X			•	X	X	X			•	$\Delta V_C$		
REMARKS:														

EARTH ORBIT BLOCK DATA

AREA	XXX-X	RECOVERY AREA FIRST 3 DIGITS - LANDING REVOLUTION LAST DIGIT - RECOVERY AREA AND SUPPORT CAPABILITIES
LAT LONG	±XX.XX (DEG) ±XXX.XX (DEG)	COORDINATES OF THE DESIRED LANDING AREA
GETI	XXX:XX:XX.XX (HR:MIN:SEC)	DEORBIT IGNITION TIME FOR THE DESIRED LANDING AREA
ΔVC	XXX. X (FPS)	DEORBIT MANEUVER ΔV TO BE LOADED INTO THE EMS COUNTER.

		LM P27 UPDATE															
PURP		V				V				V							
GET		•		•		•		•		•		•					
APRIL 16, 1969	P27	1174 01	INDEX				INDEX				INDEX				P27		
		02															
		03															
		04															
		05															
		06															
		07															
		10															
		11															
		12															
		13															
		14															
		15															
		16															
		17															
		20															
		21															
		22															
		23															
		24															
		N34		HRS	X	X	X					X	X	X			
				MIN	X	X	X	X				X	X	X		X	
		NAV CHECK SEC			X	X											
N43		LAT		0						0							
		LONG															
		ALT	+	0					+	0							

P27 UPDATE-LM

PURP	XXX	TYPE OF DATA TO BE RECEIVED (SUCH AS: LDG TIME)
V	XX (VERB)	TYPE OF COMMAND LOAD (70-71-72-73)
GET	XXX:XX:XX (HR:MIN:SEC)	TIME DATA RECORDED
1174 01	XX (OCTAL)	INDEX NO. OF COMMAND WORDS IN LOAD
02-24	XX (OCTAL)	CORRECTION WORD IDENTIFIERS
N34 NAV CHECK TIME	XXX:XX:XX.XX (HR:MIN:SEC)	TIME FOR CONFIRMATION OF GROUNDTRACK
N43		
LAT	XX.XX (DEG)	LATITUDE FOR GROUND TRACK CONFIRMATION
LONG	XXX.XX (DEG)	LONGITUDE FOR GROUND TRACK CONFIRMATION
ALT	XXX.X (NM)	ALTITUDE FOR GROUND TRACK CONFIRMATION

		AGS STATE VECTOR UPDATE															
												PURP					
APRIL 5, 1969															240		
															241		
															242		
															260		
															261		
															262		
		+												+	254		
															244		
															245		
															246		
															264		
															265		
															266		
		+												+	272		
		REMARKS:															
	AS SV																AGS SV

AGS STATE VECTOR UPDATE

PURP		PURPOSE FOR AGS STATE VECTOR UPDATE
240	±XXXXXX (100 FT)	LM STATE VECTOR-POSITION COMPONENTS
241	±XXXXXX (100 FT)	
242	±XXXXXX (100 FT)	
260	±XXXX.X (FPS)	LM STATE VECTOR-VELOCITY COMPONENTS
261	±XXXX.X (FPS)	
262	±XXXX.X (FPS)	
254	+XXXX.X (MIN)	LM TIME FOR WHICH THE STATE VECTOR IS ACCURATE
244	±XXXXXX (100 FT)	CSM STATE VECTOR-POSITION COMPONENTS
245	±XXXXXX (100 FT)	
246	±XXXXXX (100 FT)	
264	±XXXX.X (FPS)	CSM STATE VECTOR-VELOCITY COMPONENTS
265	±XXXX.X (FPS)	
266	±XXXX.X (FPS)	
272	+XXXX.X (MIN)	CSM TIME FOR WHICH THE STATE VECTOR IS ACCURATE

JUNE 18, 1969

		PHASING				P30 LM MANEUVER			
HR	N33	+	0	0		+	0	0	
MIN	TIG	+	0	0	0	+	0	0	0
SEC		+	0			+	0		
$\Delta V_X$	N81				•				•
$\Delta V_Y$	LOCAL				•				•
$\Delta V_Z$	VERT				•				•
H <sub>A</sub>	N42	+			•	+			•
H <sub>p</sub>					•				•
$\Delta V_R$		+			•	+			•
BT		X	X	X	•	X	X	X	•
R	FDAI	X	X	X		X	X	X	
P	INER	X	X	X		X	X	X	
$\Delta V_X$	AGS N86				•				•
$\Delta V_Y$	AGS				•				•
$\Delta V_Z$	AGS				•				•
BSS		X	X	X		X	X	X	
SPA		X	X		•	X	X		•
SXP		X	X	X	•	X	X	X	•



PHASING

N33 PHASING TIG                    XXX:XX:XX.XX                    IGNITION TIME OF LM MANEUVER  
(HR:MIN:SEC)

N81 LOCAL VERTICAL  $\Delta V$

$\Delta V_X$                      $\pm XXXX.X$  (FPS)                    LOCAL VERTICAL  $\Delta V$  COMPONENTS  
 $\Delta V_Y$                      $\pm XXXX.X$  (FPS)                    OF THE MANEUVER  
 $\Delta V_Z$                      $\pm XXXX.X$  (FPS)

N42 ORBITAL PARAMETERS

HA                    +XXXX.X (NM)                    PREDICTED APOGEE RESULTING  
FROM MANEUVER  
HP                     $\pm XXXX.X$  (NM)                    PREDICTED PERIGEE RESULTING  
FROM MANEUVER  
 $\Delta V_R$                     +XXXX.X (FPS)                    TOTAL  $\Delta V$  REQUIRED FOR THE  
MANEUVER  
BT                    X:XX (MIN:SEC)                    DURATION OF THE MANEUVER

FDAI

R                    XXX (DEG)                    INERTIAL FDAI ANGLES AT THE  
P                    XXX (DEG)                    BURN ATTITUDE

AGS  $\Delta V$

$\Delta V_X$  AGS                     $\pm XXXX.X$  (FPS)                    LOCAL VERTICAL  $\Delta V$  COMPONENTS OF  
 $\Delta V_Y$  AGS                     $\pm XXXX.X$  (FPS)                    THE MANEUVER TO TARGET THE AGS  
 $\Delta V_Z$  AGS                     $\pm XXXX.X$  (FPS)  
BSS                    XX (OCTAL)                    BSS STAR FOR MANEUVER  
ATTITUDE CHECK  
SPA                     $\pm XX.X$  (DEG)                    BSS PITCH ANGLE ON COAS, &  
SXP                     $\pm XX.X$  (DEG)                    BSS X POSITION ON COAS FOR  
MANEUVER ATTITUDE CHECK

P30	P30 LM Maneuver												PURPOSE	P30										
	+	0	0										+	0	0								HR	N33
	+	0	0	0									+	0	0	0							MIN	TIG
	+	0			•								+	0							•		SEC	
						•																•	$\Delta V_X$	N81
							•															•	$\Delta V_Y$	LOCAL
								•														•	$\Delta V_Z$	VERT
	+						•						+									•	H $\alpha$	N42
								•														•	H $\rho$	
	+								•				+									•	$\Delta V_R$	
	X	X	X			•							X	X	X							•	BT	
	X	X	X										X	X	X								R	FDAI
	X	X	X										X	X	X								P	INER
							•															•	$\Delta V_X$ AGS	N86
								•														•	$\Delta V_Y$ AGS	
									•													•	$\Delta V_Z$ AGS	
	X	X	X										X	X	X								BSS	
	X	X					•						X	X								•	SPA	
	X	X	X										X	X	X							•	SXP	
REMARKS:																								

P30 LM MANEUVER

PURPOSE	XXXXX	PURPOSE OF MANEUVER (SUCH AS DOI TARGETING)
N33 TIG OF MANEUVER	XXX:XX:XX.XX (HR:MIN:SEC)	IGNITION TIME FOR THE MANEUVER

N81 LOCAL VERTICAL  $\Delta V$

$\Delta V_X$	$\pm XXXX.X$ (FPS)	LOCAL VERTICAL $\Delta V$ COMPONENTS OF THE MANEUVER
$\Delta V_Y$	$\pm XXXX.X$ (FPS)	
$\Delta V_Z$	$\pm XXXX.X$ (FPS)	

N42 ORBITAL PARAMETERS

HA	+XXXX.X (NM)	PREDICTED APOGEE AND PERIGEE RESULTING FROM MANEUVER
HP	$\pm XXXX.X$ (NM)	
$\Delta V_R$	+XXXX.X (FPS)	TOTAL $\Delta V$ REQUIRED FOR THE MANEUVER
BT	X:XX (MIN:SEC)	DURATION OF THE MANEUVER

FDAI

R	XXX (DEG)	INERTIAL FDAI ANGLES AT THE BURN ATTITUDE
P	XXX (DEG)	

N86 AGS  $\Delta V$

$\Delta V_X$ AGS	$\pm XXXX.X$ (FPS)	LOCAL VERTICAL $\Delta V$ COMPONENTS OF THE MANEUVER USED TO TARGET THE AGS
$\Delta V_Y$ AGS	$\pm XXXX.X$ (FPS)	
$\Delta V_Z$ AGS	$\pm XXXX.X$ (FPS)	
BSS	XX (OCTAL)	BSS STAR FOR BURN ATTITUDE CHECK
SPA	$\pm XX.X$ (DEG)	BSS PITCH ANGLE ON COAS, & BSS X POSITION ON COAS FOR MANEUVER ATTITUDE CHECK
SXP	$\pm XX.X$ (DEG)	

DOI DATA CARD

		P30														
HR	N33	+	0	0					+	0	0					
MIN	TIG	+	0	0	0				+	0	0	0				
SEC		+	0						+	0						
ΔVX	N81															
ΔVY	LOCAL															
ΔVZ	VERT															
H <sub>A</sub>	N42	+							+							
H <sub>p</sub>																
ΔVR		+							+							
BT		X	X	X					X	X	X					
R	FDAI	X	X	X					X	X	X					
P	INER	X	X	X					X	X	X					
ΔVX AGS	N86															
ΔVY AGS																
ΔVZ AGS																
BSS		X	X	X					X	X	X					
SPA		X	X						X	X						
SXP		X	X	X					X	X	X					

LR SELF TEST

H TM (+7994±30) \_\_\_\_\_

Ḣ TM (-480±6) \_\_\_\_\_

N66 SLANTRNG (+08275.±5.0) \_\_\_\_\_

N67 VX (-00494. ±2.0) \_\_\_\_\_

VY (+01858. ±2.0) \_\_\_\_\_

VZ (+01329. ±2.0) \_\_\_\_\_

RR / TM / VHF

R<sub>1</sub>
R<sub>2</sub>
Ṙ

N73 \_\_\_\_\_

TM \_\_\_\_\_

CMC \_\_\_\_\_

VHF \_\_\_\_\_

P52 STAR 1 \_\_\_\_\_ 2 \_\_\_\_\_ 3 \_\_\_\_\_

N05 (STAR ≠ DIFF) \_\_\_\_\_

N93 (TORQUING ≠) X \_\_\_\_\_

Y \_\_\_\_\_

Z \_\_\_\_\_

GET \_\_\_\_ : \_\_\_\_ : \_\_\_\_

RESIDUALS

		PGNS				AGS			
ΔVX						500			
ΔVY	N85					501			
ΔVZ						502			

OR

MANUAL SHUT-DOWN

A. ΔVG NEGATIVE (PGNS)

B. VT: 2 SECONDS OVER BURN  
- AND -  
AGS VGX 2 FPS OVER

---

MANUAL TAKEOVER

ATT ±5° RATE ±5°/sec





PDI DATA CARD

PDI PAD

TIG PDI	XXX:XX:XX.XX (HR:MIN:SEC)	PDI IGNITION TIME
TGO	XX:XX (MIN:SEC)	TIME TO HIGH GATE
CROSSRANGE	±XXXX.X (NM)	OUT-OF-PLANE DISTANCE BETWEEN THE INITIAL LM ORBITAL PLANE AND THE LANDING SITE (POSITIVE INDICATES LANDING SITE IS NORTH OF ORBITAL PLANE)
FDAI AT TIG		
R	XXX (DEG)	INERTIAL FDAI ANGLES AT IGNITION
P	XXX (DEG)	
Y	XXX (DEG)	
DEDA 231 (IF REQ'D)	XXXXX (100 FT)	LUNAR RADIUS AT THE LANDING SITE

PDI ABORT <10 MIN

TPI TIG	XXX:XX:XX.XX (HR:MIN:SEC)	TPI IGNITION TIME
---------	------------------------------	-------------------

PDI ABORT >10 MIN

PHASING TIG	XXX:XX:XX.XX (HR:MIN:SEC)	TIME OF IGNITION OF LM PHASING MANEUVER
TPI TIG	XXX:XX:XX.XX (HR:MIN:SEC)	TPI IGNITION TIME





THIS PAGE INTENTIONALLY LEFT BLANK.

LUNAR SURFACE DATA CARD

T 2 ABORT										
HRS	T2	+	0	0			+	0	0	
MIN	TIG	+	0	0	0		+	0	0	0
SEC		+	0		.		+	0		.
HRS	N33	+	0	0			+	0	0	
MIN	PHASING	+	0	0	0		+	0	0	0
SEC	TIG	+	0		.		+	0		.
HRS	N11	+	0	0			+	0	0	
MIN	CSI <sub>1</sub>	+	0	0	0		+	0	0	0
SEC		+	0		.		+	0		.
HRS	N37	+	0	0			+	0	0	
MIN	TPI	+	0	0	0		+	0	0	0
SEC		+	0		.		+	0		.

P68

N43 \_\_\_\_\_ . \_\_\_\_\_ LAT  
 \_\_\_\_\_ . \_\_\_\_\_ LONG  
 \_\_\_\_\_ . \_\_\_\_\_ ALT

P12

N76 \_\_\_\_\_ . \_\_\_\_\_ V (HOR) (5515.2)  
 \_\_\_\_\_ . \_\_\_\_\_ V (VERT) ( 19.6)  
 \_\_\_\_\_ . \_\_\_\_\_ CROSSRANGE ( 0.0)

NOTE: IF CROSSRANGE >8 N.M., LOAD 8 N.M.

N74 \_\_\_\_\_ . \_\_\_\_\_ YAW  
 \_\_\_\_\_ . \_\_\_\_\_ PITCH

T 3 ABORT										
HRS	T3	+	0	0			+	0	0	
MIN	TIG	+	0	0	0		+	0	0	0
SEC		+	0		.		+	0		.
HRS	CSM	+	0	0			+	0	0	
MIN	PERIOD	+	0	0	0		+	0	0	0
SEC		+	0		.		+	0		.
HRS		+	0	0			+	0	0	
MIN	P+ΔT	+	0	0	0		+	0	0	0
SEC		+	0		.		+	0		.
HRS	N11	+	0	0			+	0	0	
MIN	CSI TIG	+	0	0	0		+	0	0	0
SEC		+	0		.		+	0		.
HRS	N37	+	0	0			+	0	0	
MIN	TPI	+	0	0	0		+	0	0	0
SEC		+	0		.		+	0		.

P12

N76 \_\_\_\_\_ . \_\_\_\_\_ V (HOR) (5535.6)  
 \_\_\_\_\_ . \_\_\_\_\_ V (VERT) ( 32.0)  
 \_\_\_\_\_ . \_\_\_\_\_ CROSSRANGE ( 0.0)

NOTE: IF CROSSRANGE >8 N.M., LOAD 8 N.M.

N74 \_\_\_\_\_ . \_\_\_\_\_ YAW  
 \_\_\_\_\_ . \_\_\_\_\_ PITCH

LUNAR SURFACE DATA CARD

T2 ABORT

T2 TIG	XXX:XX:XX.XX (HR:MIN:SEC)	LIFTOFF TIME - SECOND PREFERRED TIME AFTER TOUCHDOWN (~T.D. +12 MIN.)
N33 PHASING TIG	XXX:XX:XX.XX (HR:MIN:SEC)	TIME OF IGNITION FOR PHASING BURN
N11 CSI TIG	XXX:XX:XX.XX (HR:MIN:SEC)	TIME OF IGNITION FOR CSI BURN
N37 TPI TIG	XXX:XX:XX.XX (HR:MIN:SEC)	TIME OF IGNITION FOR TPI BURN

T3 ABORT

T3 TIG	XXX:XX:XX.XX (HR:MIN:SEC)	LIFT OFF TIME AFTER FIRST CSM REVOLUTION
CSM PERIOD	XXX:XX:XX.XX (HR:MIN:SEC)	CSM ORBITAL PERIOD
P + $\Delta T$	XXX:XX:XX.XX (HR:MIN:SEC)	CSM PERIOD PLUS THE TIME INTERVAL BETWEEN CLOSEST APPROACH AND LIFTOFF TIMES
N11 CSI TIG	XXX:XX:XX.XX (HR:MIN:SEC)	TIME OF IGNITION FOR CSI BURN
N37 TPI TIG	XXX:XX:XX.XX (HR:MIN:SEC)	TIME OF IGNITION FOR TPI BURN

LM ASCENT PAD

+	0	0				+	0	0				HR	
+	0	0	0			+	0	0	0			MIN	TIG
+	0			•		+	0			•		SEC	
+					•	+					•	V (HOR)	
+					•	+					•	V (VERT) N76	
	0				•		0				•	*CROSSRANGE	
												DEDA 047	
												DEDA 053	
												DEDA 225/226	
												DEDA 231	

\*NOTE: LOAD 8 NM IF CROSSRANGE IS GREATER THAN 8 NM  
 COMMENTS:

LM ASCENT PAD

ASCENT TIG	XXX:XX:XX.XX (HR:MIN:SEC)	TIME OF APS IGNITION FOR LM ASCENT
N76 INSERTION TARGET		
V (HOR)	XXXX.X (FPS)	HORIZONTAL VELOCITY AT ORBIT INSERTION
V (VERT)	XXXX.X (FPS)	VERTICAL VELOCITY AT ORBIT INSERTION
CROSSRANGE	±XXXX.X (NM)	CROSSRANGE DISTANCE AT ORBITAL INSERTION
DEDA 047	XXXXXX (OCTAL)	SINE OF LANDING AZIMUTH ANGLE
DEDA 053	XXXXXX (OCTAL)	COSINE OF LANDING AZIMUTH ANGLE
DEDA 225	XXXXXX (100 FT)	LOWER LIMIT OF $\alpha$ AT ORBIT INSERTION
DEDA 226	XXXXXX (100 FT)	UPPER LIMIT OF $\alpha$ AT ORBIT INSERTION
DEDA 231	XXXXXX (100 FT)	RADIAL DISTANCE OF LAUNCH SITE FROM CENTER OF MOON



CSI DATA CARD (P32 LM MANEUVER)

N11 CSI TIG	XXX:XX:XX.XX (HR:MIN:SEC)	CSI IGNITION TIME
N37 TPI TIG	XXX:XX:XX.XX (HR:MIN:SEC)	TPI IGNITION TIME
N81		
$\Delta$ VX	XXX.X (FPS)	LOCAL VERTICAL $\Delta$ V COMPONENTS OF
$\Delta$ VY	XXX.X (FPS)	THE CSI MANEUVER
FDAI PITCH	XXX (DEG)	FDAI INERTIAL PITCH ANGLE AT THE CSI BURN ATTITUDE
DEDA 373	XXXX.X (MIN)	AGS IGNITION TIME OF NEXT MANEUVER
DEDA 275	XXXX.X (MIN)	DESIRED TPI TIG (FOR CSI CALCULATION ONLY)
N86 AGS $\Delta$ V		
$\Delta$ VX AGS	XX.XX (FPS)	LOCAL VERTICAL $\Delta$ V COMPONENTS OF
$\Delta$ VY AGS	XX.XX (FPS)	CSI USED TO TARGET AGS EXT $\Delta$ V
$\Delta$ VZ AGS	XX.XX (FPS)	

CDH PAD

CDH DATA CARD

June 19, 1969

HRS	N13	+	0	0			+	0	0		
MIN	TIG	+	0	0	0		+	0	0	0	
SEC	CDH	+	0			.	+	0			.
$\Delta V_X$			0			.		0			.
$\Delta V_Y$	N81		0			.		0			.
$\Delta V_Z$			0			.		0			.
PLM	FDAI	X	X	X			X	X	X		
373 (+0379.6)		+				.	+				.
$\Delta V_X$	N86		0			.		0			.
$\Delta V_Y$	AGS		0			.		0			.
$\Delta V_Z$			0			.		0			.

PLANE CHANGE P30, V90, 410+5	
TIG	CDH _____ : _____ : _____ . _____
	_____ : 3 0 : 0 0 . 0 0
TIG	PC _____ : _____ : _____ . _____

YDOT		
CSM	N90	PGNS N90
AGS	263	
(-) _____ .	(-) _____ .	(-) _____ .
(-) _____ .	(-) _____ .	(-) _____ .

RESIDUALS		
	PGNS	AGS
$\Delta V_X$	N85 _____ .	500 _____ .
$\Delta V_Y$	_____ .	501 _____ .
$\Delta V_Z$	_____ .	502 _____ .

RESIDUALS		
	PGNS	AGS
$\Delta V_X$	N85 _____ .	500 _____ .
$\Delta V_Y$	_____ .	501 _____ .
$\Delta V_Z$	_____ .	502 _____ .

2 - 46

<b>P G N C S</b>	N75			N81			<b>P G N C S</b>
	$\Delta H$ (15.0)	$\Delta T$ TPI/CDH (37:31)	TPI SLIP (0:00)	$\Delta V_X$ (-1.1)	YDOT N90 CDH (+0.0)	$\Delta V_Z$ (+4.1)	
	_____ .	_____ .	_____ .	_____ .	(-) _____ .	_____ .	
	_____ .	_____ .	_____ .	_____ .	(-) _____ .	_____ .	
<b>A G S</b>	$\frac{402}{\Delta H}$	$\frac{450}{\Delta V_X}$	$\frac{452}{\Delta V_Z}$	$\Delta V_X$	CSM SOLUTION $\Delta V_Y$	$\Delta V_Z$	<b>A G S</b>
	_____ .	_____ .	_____ .	_____ .	_____ .	_____ .	
	_____ .	_____ .	_____ .	_____ .	_____ .	_____ .	
			N86 (AGS)				
			$\Delta V_X$	$\Delta V_Y$	$\Delta V_Z$		
			_____ .	_____ .	_____ .		





HRS	N37	+	0	0			+	0	0		
MIN	TIG	+	0	0	0		+	0	0	0	
SEC	TPI	+	0				+	0			
N55		(BLANK)	(+026.60)	(+130.00)							
$\Delta V X$	N81		0					0			
$\Delta V Y$			0					0			
$\Delta V Z$			0					0			
$\Delta V R$	N42	+	0	0			+	0	0		
RLM		X	X	X			X	X	X		
PLM		X	X	X			X	X	X		
R TPI	N54	+	0				+	0			
R TPI	TIG -5		0					0			
F/A (+/-)	N59		0	0				0	0		
R/L (+/-)	$\Delta V$		0	0				0	0		
D/U (+/-)	LOS		0	0				0	0		
BT		X	X				X	X			
307+043.00, 314+0											

		RESIDUALS					
		PGNS			AGS		
$\Delta V X$					500		
$\Delta V Y$	N85				501		
$\Delta V Z$					502		

2 - 48

P G N S	N58			N81						P G N S
	HP ( )	$\Delta V$ TPI ( )	$\Delta V$ TPF ( )	$\Delta V X$ ( )	$\Delta V Y$ ( )	$\Delta V Z$ ( )	$\Delta V$ F/A- ( )	$\Delta V$ R/L- ( )	$\Delta V$ D/U- ( )	
	.	.	.	.	.	.	.	.	.	
	.	.	.	.	N90	.	.	.	.	
	.	.	.	.	.	.	.	.	.	
	.	.	.	.	.	.	.	.	.	
A G S		<u>267</u> $\Delta V$ TPI	<u>371</u> $\Delta V$ TPI+TPF	CSM SOLUTION						A G S
				$\Delta V X$	$\Delta V Y$	$\Delta V Z$				
				$\Delta V X$	N86 (AGS) $\Delta V Y$	$\Delta V Z$				
				.	.	.				

TPI DATA CARD

N37 TPI TIG	XXX:XX:XX.XX (HR:MIN:SEC)	IGNITION TIME FOR THE TPI MANEUVER
N81 LOCAL VERTICAL $\Delta V$		
$\Delta V_X$	$\pm XX.X$ (FPS)	LOCAL VERTICAL $\Delta V$ COMPONENTS OF THE TPI MANEUVER
$\Delta V_Y$	$\pm XX.X$ (FPS)	
$\Delta V_Z$	$\pm XX.X$ (FPS)	
N42 $\Delta V_R$	$+XX.X$ (FPS)	TOTAL $\Delta V$ REQUIRED FOR THE MANEUVER
RLM	XXX (DEG)	ROLL AND PITCH FDAI ANGLES AT TPI BURN ATTITUDE
PLM	XXX (DEG)	
N54 TIG -5		
R TPI	XX.XX (FT)	RANGE AT TPI TIG -5 MIN
R TPI	$\pm XXX.X$ (FPS)	RANGE RATE AT TPI TIG -5 MIN
N59 $\Delta V$ LOS		
F/A	$\pm XX.X$ (FPS)	LINE-OF-SIGHT $\Delta V$ COMPONENTS OF THE TPI MANEUVER
R/L	$\pm XX.X$ (FPS)	
D/U	$\pm XX.X$ (FPS)	
BT	XX:XX (MIN:SEC)	DURATION OF THE MANEUVER



SECTION III

**DETAILED TIMELINE**



TIME	EVENT	REMARKS		
-00:09	LCC: <u>REPORT</u> IGNITION	FIRST OPPORTUNITY LIFT-OFF JULY 16, 0932 EDT, 72° LA, TARGETED FOR LANDING SITE 2. LIFT-OFF: 1332 GMT		
00:00	LCC: CDR: <u>REPORT</u> LIFT-OFF			
00:02	CDR: <u>REPORT</u> YAW MNVR			
00:10	LCC: <u>REPORT</u> CLEAR OF TOWER			
00:15	CDR: <u>REPORT</u> ROLL AND PITCH PROGRAM INITIATE			
00:32	CDR: <u>REPORT</u> ROLL COMPLETE			
00:42	MCC: <u>REPORT</u> MARK MODE IB			
00:51	LMP: <u>REPORT</u> CABIN PRESS DECREASING			
01:21	MAX Q			
01:56	MCC: <u>REPORT</u> MARK MODE IC			
02:00	MCC: CDR: <u>REPORT</u> GO/NO GO FOR STAGING			
02:15	CDR: <u>REPORT</u> INBOARD OUT			
02:41	CDR: <u>REPORT</u> OUTBOARD OUT			
02:42	CDR: <u>REPORT</u> STAGING / S-II IGNITION			
03:12	CDR:        S-II SEP LIGHT OUT			
03:17	CDR: <u>REPORT</u> TWR JETT AND MODE II			
03:21	CDR: <u>REPORT</u> GUIDANCE			
<b>MISSION G</b>			<b>EDITION FINAL</b>	<b>DATE JULY 1, 1969</b>

TIME	EVENT	REMARKS		
04:00	MCC: <u>REPORT</u> TRAJECTORY AND GUIDANCE GO/NO GO			
04:00	CDR: <u>REPORT</u> S/C GO/NO GO			
05:00	CDR: <u>REPORT</u> S/C GO/NO GO			
05:25	MCC: <u>REPORT</u> S-IVB TO ORBIT CAPABILITY			
06:00	CDR: <u>REPORT</u> S/C GO/NO GO			
07:00	CDR: <u>REPORT</u> S/C GO/NO GO			
08:00	CDR: <u>REPORT</u> S/C GO/NO GO			
08:30	MCC: CDR: <u>REPORT</u> GO/NO GO FOR STAGING			
08:57	MCC: <u>REPORT</u> MODE IV			
	CDR: <u>REPORT</u> S/C GO/NO GO			
	MCC: <u>REPORT</u> TRAJECTORY AND GUIDANCE GO/NO GO			
09:11	CDR: <u>REPORT</u> S-II CUTOFF			
09:15	CDR: <u>REPORT</u> S-IVB IGNITION			
10:00	MCC: CDR: <u>REPORT</u> GO/NO GO FOR ORBIT			
	MCC: <u>REPORT</u> PREDICTED SECO			
11:40	CDR: <u>REPORT</u> SECO TB <sub>5</sub> = 0  S-IVB MAINTAINS COMMANDED CUTOFF INTERTIAL ATTITUDE	IMU GIMBAL ANGELS @INSERTION R 180° P 340° Y 0°  H pad 103.3 NM		
<b>MISSION G</b>		<b>EDITION FINAL</b>	<b>DATE JULY 1, 1969</b>	<b>PAGE 3-ii</b>



MCC-H

0930 EDT

00:00

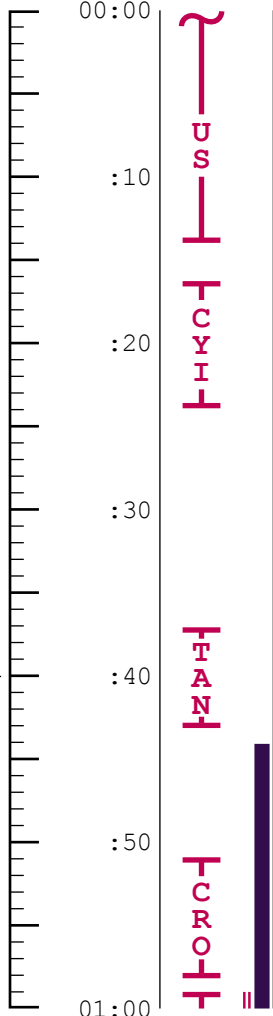

# FLIGHT PLAN

NOTES

LIFTOFF

### SECO-INSERTION CHECKLIST

- LMP - SM RCS MON CK, CM RCS MON CK, C&W OPERATIONAL CK
- REMOVE AND STOW HELMETS AND GLOVES
- UNSTOW CAMERAS
- CMP - TRANS TO LEB - O<sub>2</sub> MAIN REG CK
- CMP/LMP - SEC RAD LEAK CK
- CDR/CMP - ECS POST INSERTION CONFIG
- LMP - FUEL CELL PURGE CK; EPS MON CK, FUEL CELL POWER PLANT CK, DC VOLT - AMP CK, ECS MON CK, SPS MON CK
- GDC ALIGN TO IMU - RECORD DRIFT
- CDR - UNSTOW SEQ CAMERA BRACKET AND ORDEAL
- INSTALL ORDEAL & COAS
- MOUNT AND INITIALIZE ORDEAL
- CMP - ECS REDUNDANT COMPONENT CHECK
- JETTISON OPTICS COVER (DIRECT, HIGH, SHAFT RIGHT)
- RECORD ΔAZ CORRECTION

### SET UP CAMERA EQUIP (T&D)

16mm/18/CEX-BRKT-MIR  
 (f8, 250, 7) 6 FPS  
 1 MAG (FOR T&D)  
 EL/80/CEX  
 (f8, 250, INF)

IMU REALIGN - P52  
 (OPTION 3 - REFSMMAT)  
 (OPTIONAL)

S-BAND VOL - UP FOR HSK

TWO-WAY USB VOICE CK

LIFTOFF CREW POSITIONS  
 LEFT COUCH - CDR  
 CENTER COUCH - LMP  
 RIGHT COUCH - CMP  
 INSERTION IMU GIMBAL ANGLES  
 P 340 R 180 Y 0  
 AT SECO +20 SEC, SIV-B MNVRS  
 TO LH AND INITIALIZES ORB  
 RATE (HEADS DOWN)

COOLANT CONTROL ATTENUATION PANEL NOT OPENED

### REPORT

P52 - (PAD REFSMMAT)

N71: \_ \_ , \_ \_

N05: \_ \_ . \_ \_

N93:

X \_ \_ . \_ \_

Y \_ \_ . \_ \_

Z \_ \_ . \_ \_

GET \_ \_ : \_ \_ : \_ \_

UPDATE

ΔAZ CORRECTION

MISSION	EDITION	DATE	TIME	DAY / REV	PAGE
APOLLO 11	FINAL	JULY 1, 1969	00:00 - 01:00	1 / 1	3-1

MCC-H

1030 EDT

01:00

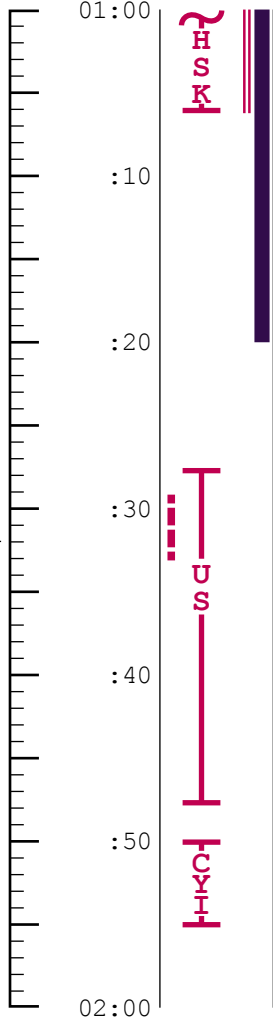

UPLINK CMC

CSM STATE VECTOR

UPDATE

PAD DATA

GO/NO GO

# FLIGHT PLAN

P52 - CONT'D

GDC ALIGN TO IMU  
STOW OPTICS

SCS ATT REF COMPARISON CK  
EXTEND DOCKING PROBE

V66 - TRANS CSM STATE VECTOR TO LM SLOT  
RECORD PAD DATA  
(TLI, TLI +90 MIN ABORT, AND P37 - TLI +4 HR ABORT)  
SM RCS HOT FIRE  
(MIN IMPULSE - ALL JETS)

GO/NO GO FOR PYRO ARM  
BEGIN TLI PREPARATION (CHECKLIST PG L-2-19)  
DON HELMETS & GLOVES - ALL

EMS ΔV TEST

NOTES

AS A GENERAL RULE MSFN WILL ALWAYS UPLINK THE STATE VECTOR TO THE CSM SLOT AND THE CREW WILL TRANSFER IT VIA V66 TO THE LM SLOT

MISSION	EDITION	DATE	TIME	DAY / REV	PAGE
APOLLO 11	FINAL	JULY 1, 1969	01:00 - 02:00	1 / 1	3-2

THIS PAGE INTENTIONALLY LEFT BLANK.

TLI  
BURN CHART

	P OR Y RATES	ATT DEVIATION	SHUTDOWN TIME	RESIDUALS
TLI	10°/SEC SHUTDOWN	±45° SHUTDOWN	BT +6 SEC & VI = PAD VALUE	DO NOT TRIM

MCC-H

# FLIGHT PLAN

NOTES

1130 EDT

02:00

:10

:20

:30

:40

:50

03:00

GO/NO GO

FINAL

FORC

PEM

NSM

GDC ALIGN TO IMU  
PYRO LOGIC ARM  
CMP - TRANS TO COUCH

SET ORDEAL TO ORB RATE

GO/NO GO FOR TLI

TB-6 (02:34:48)

THRUST MON - P47

P00 - CMC IDLING  
V66 - TRANS CSM SV TO LM SLOT  
TLI BURN STATUS REPORT  
CDR - TRANS TO CENTER COUCH, CMP - LEFT COUCH, LMP - RIGHT COUCH

TLI

GETI = 02:44:26  
BT = 5:20  
 $\Delta V_T = 10,451.2$  FPS  
POSIGRADE

REPORT  
TLI BURN STATUS  
VI \_\_\_\_\_  
 $\Delta VC$  \_\_\_\_\_

AT SECO: SIV-B INERTIAL  
AT SECO +20 SEC: SIV-B TO  
LOCAL HORIZONTAL ORB RATE,  
GEADS DOWN

MISSION	EDITION	DATE	TIME	DAY / REV	PAGE
APOLLO 11	FINAL	JULY 1, 1969	02:00 - 03:00	1 / 2	3-3

MCC-H

1230 EDT

# FLIGHT PLAN

NOTES

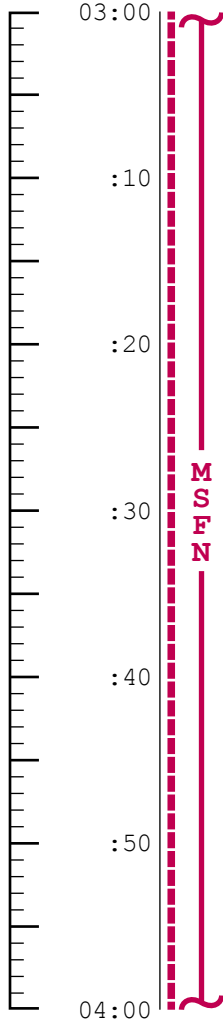

WASTE STOWAGE VENT VLV - CLOSED  
 PRESS CABIN TO 5.7 PSIA  
 GDC ALIGN TO IMU  
 VERIFY AND ACTIVATE RCS DAP  
 R1=11103, R2=01111

CSM SEP PREPARATION  
 LOAD DOCKING GIMBAL ANGLES

**CSM/SIV-B SEP**  
 GET = 03:15  
 DOCKING PHOTOGRAPHY

**DOCK** GET = 03:25  
 POST DOCKING  
 S-BAND HGA ANGLES = P \_\_\_ Y \_\_\_

CMP - INITIATE CM/LM PRESS EQUALIZATION

CONFIGURE FOR EXTRACTION  
 CHECK LM PRESS STABILIZATION  
 REMOVE AND TEMP STOW TUNNEL HATCH  
 CHECK DOCKING LATCHES  
 VENT DOCKING PROBE  
 CONNECT UMBILICALS - VERIFY PWR TO LM  
 REINSTALL HATCH  
 LM/CM ΔP VALVE - LM/CM ΔP  
 VERIFY TUNNEL EQUALIZATION - CLOSED  
 WASTE STOWAGE VENT VALVE - OPEN (FOR 8 HOURS)

START 16mm CAMERA  
 T&D MNVR  
 +X 0.8 FPS  
 AFTER 15 SEC, -X 0.3 FPS  
 AUTO MNVR TO DOCKING ATT  
 NULL TRANSLATION & RATES  
 +X TO CLOST AT .25 TO .5 FPS  
 STOP 16mm CAMERA

DAP LOAD FOR SEPARATION CSM,  
 0.5°DB, 2.0°/SEC, B/D ROLL,  
 4 JETS

EL PHOTOS AS CONVENIENT

DECISION TO END CM CABIN  
 PURGE WILL BE MADE REAL TIME  
 BASED ON LM LEAK RATE

MISSION	EDITION	DATE	TIME	DAY / REV	PAGE
APOLLO 11	FINAL	JULY 1, 1969	03:00 - 04:00	1 / TLC	3-4

THIS PAGE INTENTIONALLY LEFT BLANK.

EVASIVE MANEUVER  
BURN CHART

	P OR Y RATES	ATT DEVIATION	SHUTDOWN TIME	RESIDUALS
EVASIVE MNVR	10°/SEC TAKEOVER	±10° TAKEOVER	BT +1 SEC	DO NOT TRIM



**MCC-H**

UPDATE

EVASIVE MNVR  
GO/NO-GO

TLI CUT OFF  
+ 1 HR 50 MIN

1330 EDT

04:00

:10

:20

:30

:40

:50

05:00

M  
S  
F  
N

# FLIGHT PLAN

RECORD EVASIVE MNVR PAD  
GO/NO-GO FOR PYRO ARM & LM EJECTION  
DAP - R1 = 21101, R2 = 11111  
PYRO LOGIC ARM  
THRUST MONITOR - P47

DAP CONFIGURATION FOR  
LM EJECTION: CSM & LM  
0.5° DB, .5°/SEC, A/C  
ROLL, 4 JETS

LM EJECTION

GETI = 04:09:45  
BT = 3 SEC  
 $\Delta V_T =$

EXT  $\Delta V = P30$   
DAP - R1 = 21111, R2 = 11111  
DAP CONFIGURATION AFTER  
LM EJECTION SAME AS ABOVE  
EXCEPT CHANGE TO 5° DB

NOTE:  
WITH RT TLM, ONLY  
ITEMS NORMALLY  
REQUIRED IN BURN  
STATUS REPORT ARE  
%VC, FUEL, OX, AND  
UNBAL

SPS THRUST - P40  
PITCH DOWN 75° WRT LOCAL HORIZONTAL  
ROLL TO VISUALLY ACQ SIV-B

SM RCS MON CK  
GDC ALIGN TO IMU

EVASIVE MNVR

GETI = 04:39:45  
NO ULLAGE  
BT = 2.8 SEC  
 $\Delta V_T = 19.7$   
IN PLANE

SM RCS MON CK  
SPS MON CK  
BURN STATUS REPORT  
V66 - TRANS CSM STATE VECTOR TO LM SLOT  
MANEUVER TO OBSERVE SLINGSHOT

**NOTES**

FOR LM EJECTION  
RELATIVE  $\Delta V$  FROM  
SPRINGS = 1 FPS

BURN STATUS REPORT			
X	X	:	$\Delta TIG$
X	X	:	BT
		.	$V_{gx}$
TRIM			
X	X	X	R
X	X	X	P
X	X	X	Y
		.	$V_{gx}$
		.	$V_{gy}$
		.	$V_{gz}$
		.	$\Delta V_C$
X	X	X	FUEL
X	X	X	OX
X	X	X	UNBAL

FIRST SPS BURN WILL ALWAYS  
START ON BANK A AND  
BANK B WILL BE ACTIVATED IF  
THE BURN >5 SEC

MISSION	EDITION	DATE	TIME	DAY / REV	PAGE
APOLLO 11	FINAL	JULY 1, 1969	04:00 - 05:00	1 / TLC	3-5

MCC-H

# FLIGHT PLAN

NOTES

1430 EDT

05:00

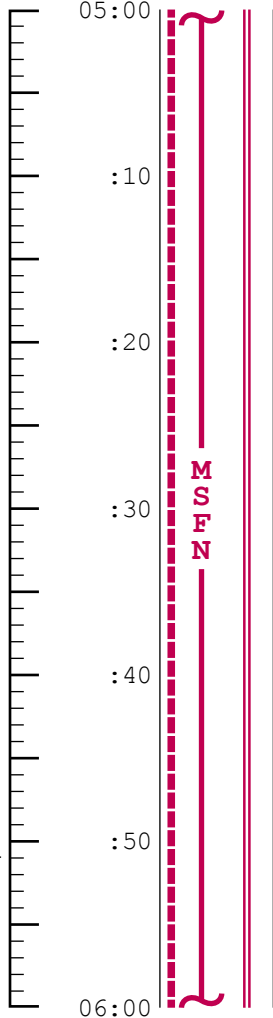

SIV-B SLINGSHOT

REPORT LM/CM ΔP

DOFF & STOW  
HELMET, GLOVES  
AND PGA'S

BATTERY CHARGE, BATTERY B

IMU REALIGN - P52  
OPTION 3 - REFSMMAT

GDC ALIGN TO IMU  
RECORD BLOCK DATA  
(P37 - TLI +11 HRS ABORT)  
MNRV TO SIGHTING ATT

REPORT

P52 - (PAD REFSMMAT)

N71: \_ \_ , \_ \_

N05: \_ \_ . \_ \_

N93:

X \_ \_ . \_ \_

Y \_ \_ . \_ \_

Z \_ \_ . \_ \_

GET \_ \_ : \_ \_ : \_ \_

UPDATE

BLOCK DATA

06:00

MISSION	EDITION	DATE	TIME	DAY / REV	PAGE
APOLLO 11	FINAL	JULY 1, 1969	05:00 - 06:00	1 / TLC	3-6

**MCC-H**

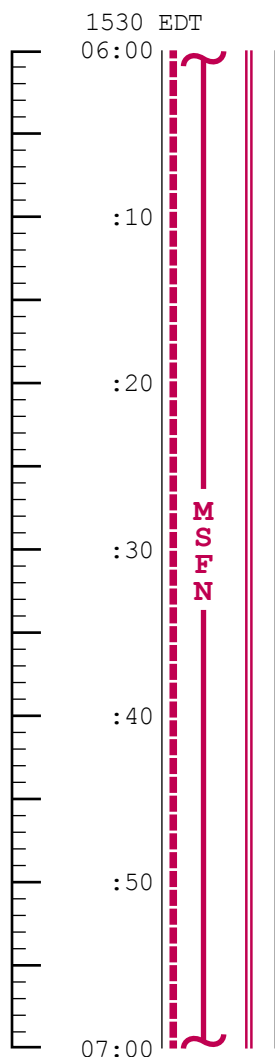

# FLIGHT PLAN

CISLUNAR NAVIGATION - P23

OPTICS CALIBRATION

1. STAR 02 ENH (R3=00110)
  
2. STAR 40 ENH (R3=00120)
  
3. STAR 44 ENH (R3=00110)
  
4. STAR 44 ENH (R3=00110)
  
5. STAR 45 ENH (R3=00110)

## NOTES

3 MARKS ON EACH STAR  
  
INCORPORATE P23 MARK  
DATA AND UPDATE  
ONBOARD STATE VECTOR  
  
TRN BIAS CALIBRATION  
REPEATED UNTIL 2 CKS  
AGREE TO WITHIN 0.003°  
REPEAT CKS EVERY 30 MIN  
DURING P23

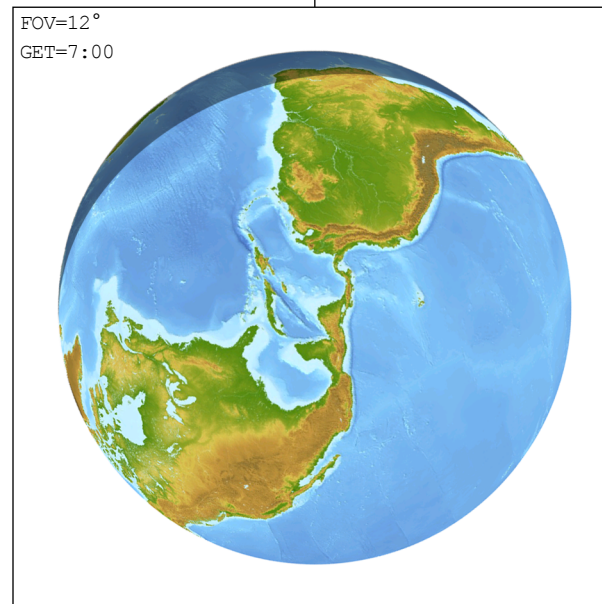

MISSION	EDITION	DATE	TIME	DAY / REV	PAGE
APOLLO 11	FINAL	JULY 1, 1969	06:00 - 07:00	1 / TLC	3-7

**MCC-H**

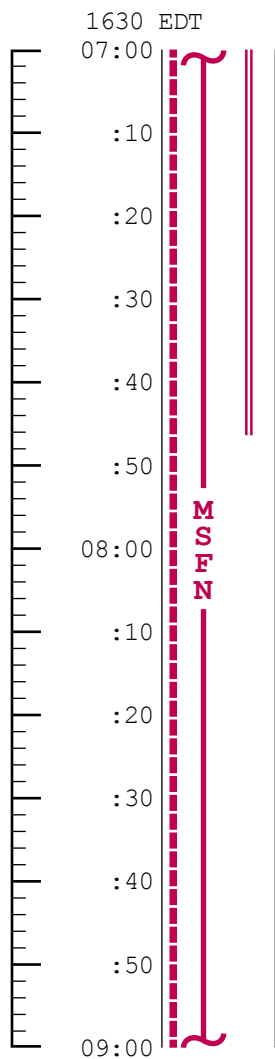

# FLIGHT PLAN

DEACTIVATE PRIMARY & SECONDARY EVAPORATORS  
MNVR TO PTS ATT P 90 Y 0 (SEE NOTES)  
SELECT NORMAL LUNAR COMM CONFIGURATION  
EXCEPT: S-BD AUX TAPE - OFF (CTR)  
                  TAPE RCDR FWD - OFF (CTR)  
POWER DOWN VHF

EAT PERIOD - ALL

**PTC**

**NOTES**

PTC WILL BE INITIATED  
AFTER MCC1, OR AFTER  
MCC1 IS SCRUBBED

PHOTOS OF EARTH AS  
CONVENIENT  
EL/250/CEX-RING  
(f11, 250)

LUNAR  
EL/250/CEX-RING  
(f5.6, 250, INF)

MISSION	EDITION	DATE	TIME	DAY / REV	PAGE
APOLLO 11	FINAL	JULY 1, 1969	07:00 - 09:00	1 / TLC	3-8

**MCC-H**

1830 EDT

09:00

:10

:20

:30

:40

:50

10:00

:10

:20

:30

:40

:50

11:00

UPLINK CMC

EARTH HORIZON  
BIAS ( $\Delta H$ )  
(IF REQUIRED)  
CSM STATE VECTOR  
MCC1 TGT LOAD

UPDATE

MCC1 MNVR PAD

M  
S  
F  
N

# FLIGHT PLAN

CO<sub>2</sub> FILTER CHANGE NO.1  
(3 INTO A, STORE 1 IN B5)

V66 - TRANS CSM STATE VECTOR TO LM SLOT

O2 FUEL CELL PURGE

RECORD MCC1 MNVR PAD

CONTINUE PTC IF MCC1 IS SCRUBBED

IMU REALIGN - P52  
OPTION 3 - REFSMMAT  
(OPTIONAL)

PTC

**NOTES**

THE EARTH HORIZON BIAS  
( $\Delta H$ ) WILL BE UPDATED  
TO THE CMC IF  
THE DIFFERENCE BETWEEN  
THE SIGHTING  $\Delta H$  & THE  
E-MEMORY  $\Delta H$  IS  $\geq 8.3$ KM

REPORT

P52 - (PAD REFSMMAT)

N71: \_ \_ \_ , \_ \_ \_

N05: \_ \_ \_ . \_ \_ \_

N93:

X \_ \_ . \_ \_ \_ \_

Y \_ \_ . \_ \_ \_ \_

Z \_ \_ . \_ \_ \_ \_

GET \_ \_ \_ : \_ \_ : \_ \_

MISSION	EDITION	DATE	TIME	DAY / REV	PAGE
APOLLO 11	FINAL	JULY 1, 1969	09:00 - 11:00	1 / TLC	3-9

MCC  
BURN CHART

	P OR Y RATES	ATT DEVIATION	SHUTDOWN TIME	RESIDUALS
MCC1	10°/SEC TAKEOVER	±10° TAKEOVER	BT +1 SEC	TRIM X AXIS ONLY (UNLESS X > 2 FPS)

**MCC-H**

2030 EDT

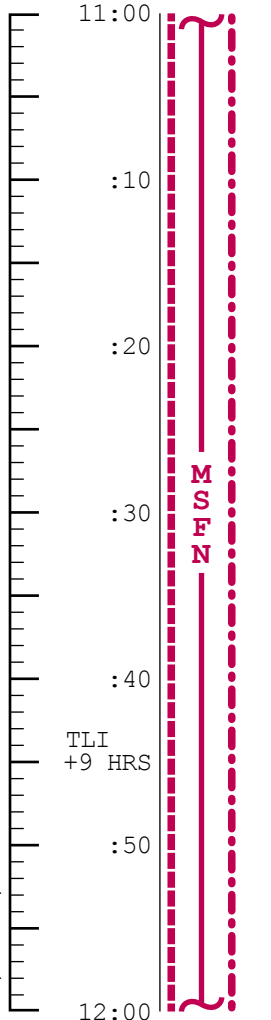

# FLIGHT PLAN

**NOTES**

EXT ΔV

SPS/RCS THRUST - P40/41

MNVR TO BURN ATT

SXT STAR CK

EMS ΔV TEST

SM RCS MON CK

GDC ALIGN TO IMU

MCC1 ΔV = NOMINALLY ZERO

SM RCS MON CK

SPS MON CK

MCC1 BURN STATUS REPORT

V66 - TRANS CSM STATE VECTOR TO LM SLOT

RECORD BLOCK DATA  
(P37 - TLI +25, +35, +44, AND +53 HR ABORTS)

BURN STATUS REPORT			
X	X	<input type="checkbox"/>	•
X	X	<input type="checkbox"/>	•
<input type="checkbox"/>	<input type="checkbox"/>	<input type="checkbox"/>	•
TRIM			
X	X	X	
X	X	X	
X	X	X	
<input type="checkbox"/>	<input type="checkbox"/>	<input type="checkbox"/>	•
<input type="checkbox"/>	<input type="checkbox"/>	<input type="checkbox"/>	•
<input type="checkbox"/>	<input type="checkbox"/>	<input type="checkbox"/>	•
<input type="checkbox"/>	<input type="checkbox"/>	<input type="checkbox"/>	•
X	X	X	
X	X	X	
X	X	X	

ΔTIG

BT

$V_{gx}$

R

P

Y

$V_{gx}$

$V_{gy}$

$V_{gz}$

$\Delta V_c$

FUEL

OX

UNBAL

MCC1 WILL BE PERFORMED  
IF ΔV WOULD EXCEED  
25 FPS IF DELAYED TO  
MCC3 (LOI -22 HRS)

UPLINK CMC

DESIRED ORIENTATION (PTC) UPDATE

BLOCK DATA

MISSION	EDITION	DATE	TIME	DAY / REV	PAGE
APOLLO 11	FINAL	JULY 1, 1969	11:00 - 12:00	1 / TLC	3-10

MCC-H

# FLIGHT PLAN

NOTES

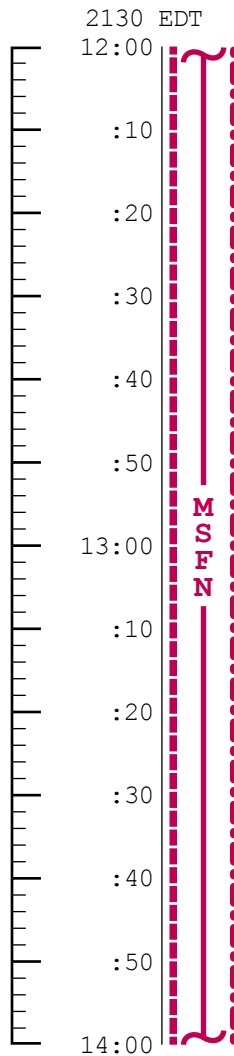

IMU REALIGN - P52  
(OPTION 1 - PREFERRED)  
& STAR CHECK  
(IF MCC1 WAS PERFORMED)

REPORT LM/CM ΔP  
BATTERY CHARGE, BATTERY A

WASTE STOWAGE VENT VLV - CLOSED

VENT BATTS UNTIL SYSTEM TEST  
METER (4A) = 0

START PTC  
P 90° Y 0°

P52 - PULSE TORQUE  
TO PTC REFSSMAT.  
ALIGNMENT CHECKED  
WITH OPTICS  
PTC ESTABLISHED IN  
G&N P, Y ±30°DB,  
R RATE OF 0.3°/SEC

EAT PERIOD - ALL

PRE SLEEP CHECKLIST

CREW STATUS REPORT (RADIATION, MEDICATION)

CYCLE O<sub>2</sub> & H<sub>2</sub> FANS  
CHLORINATE POTABLE WATER  
SELECT NORMAL LUNAR CONFIGURATION

EXCEPT:

- S-BD NORMAL MODE VOICE - OFF
- S-BD SQUELCH - ENABLE
- S-BD AUX TAPE - OFF
- S-BD ANT - OMNI
- S-BD ANT OMNI - B
- TAPE RCDR FWD - OFF

VERIFY:

- WASTE MNGT OVBD DRAIN - OFF
- WASTE STOW VENT VLV - CLOSED
- EMERG CABIN PRESS VLV - BOTH
- SURGE TK O<sub>2</sub> VLV - ON
- REPRESS PACK O<sub>2</sub> VLV - ON
- LM TUNNEL VENT VLV - LM/CM ΔP
- POT H<sub>2</sub>O HTR - OFF
- AUTO RCS JET SELECT (16) - OFF

ONBOARD READOUT

BAT C \_\_\_\_\_

PYRO BAT A \_\_\_\_\_

PYRO BAT B \_\_\_\_\_

RCS A \_\_\_\_\_

B \_\_\_\_\_

C \_\_\_\_\_

D \_\_\_\_\_

DC IND SEL TO MNA OR MNB

DURING REST PERIOD,  
2 CREWMEN IN REST  
STATION, 1 IN LEFT  
COUCH

REST PERIOD  
(9 HOURS)

MISSION	EDITION	DATE	TIME	DAY / REV	PAGE
APOLLO 11	FINAL	JULY 1, 1969	12:00 - 14:00	1 / TLC	3-11



**MCC-H**

# FLIGHT PLAN

**NOTES**

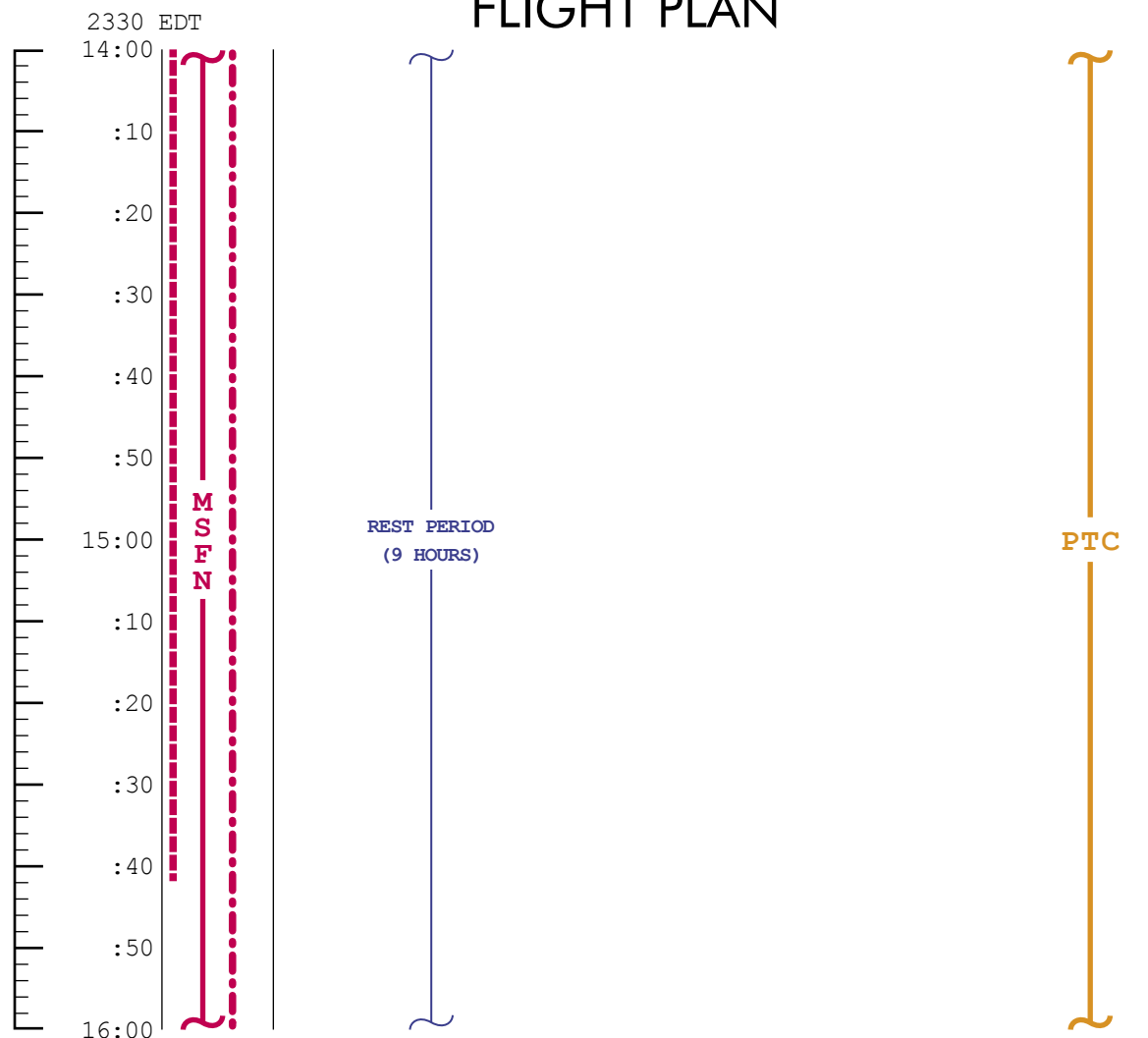

MISSION	EDITION	DATE	TIME	DAY / REV	PAGE
APOLLO 11	FINAL	JULY 1, 1969	14:00 - 16:00	1 / TLC	3-12

MCC-H

# FLIGHT PLAN

NOTES

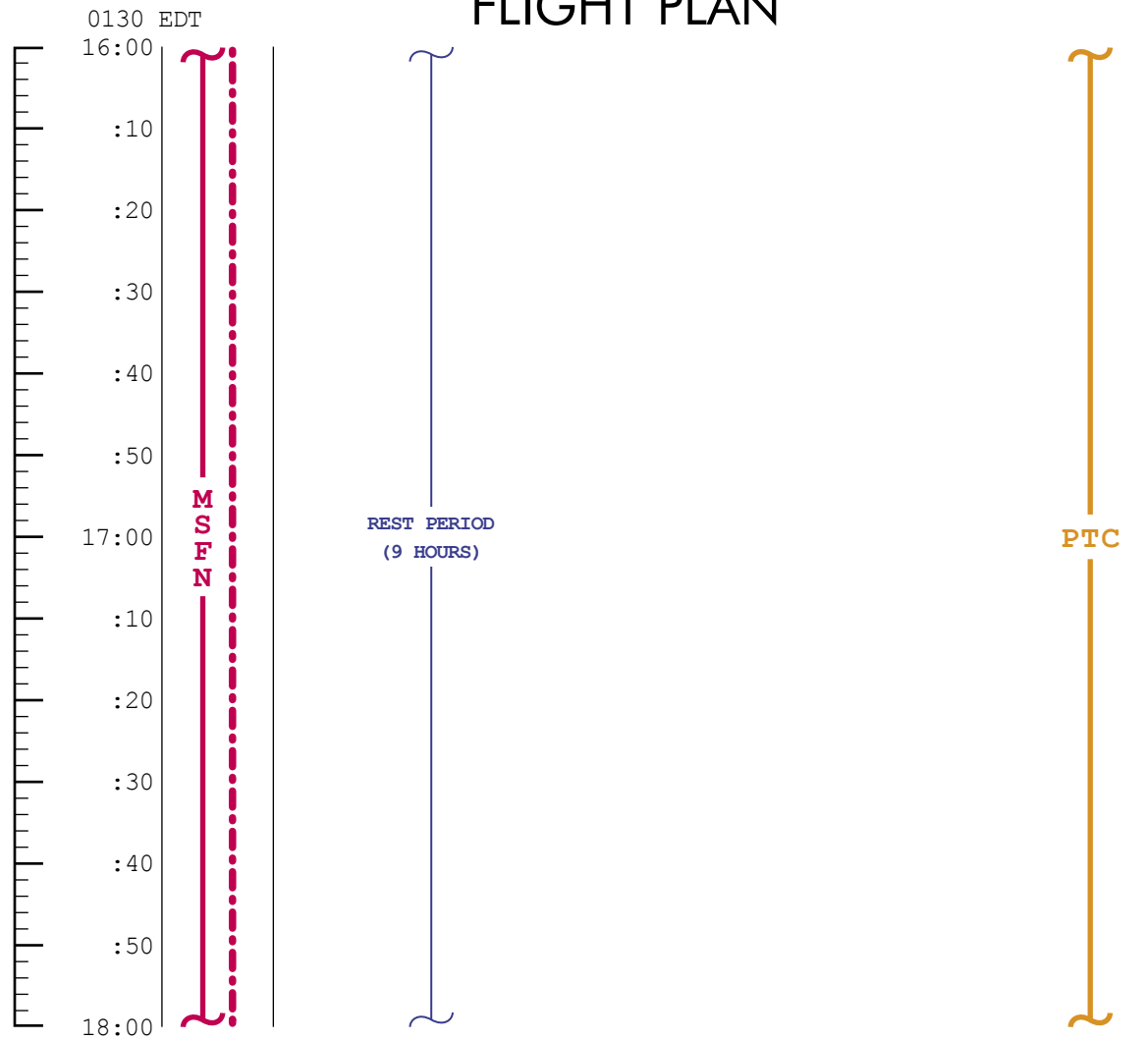

MISSION	EDITION	DATE	TIME	DAY / REV	PAGE
APOLLO 11	FINAL	JULY 1, 1969	16:00 - 18:00	1 / TLC	3-13

**MCC-H**

# FLIGHT PLAN

**NOTES**

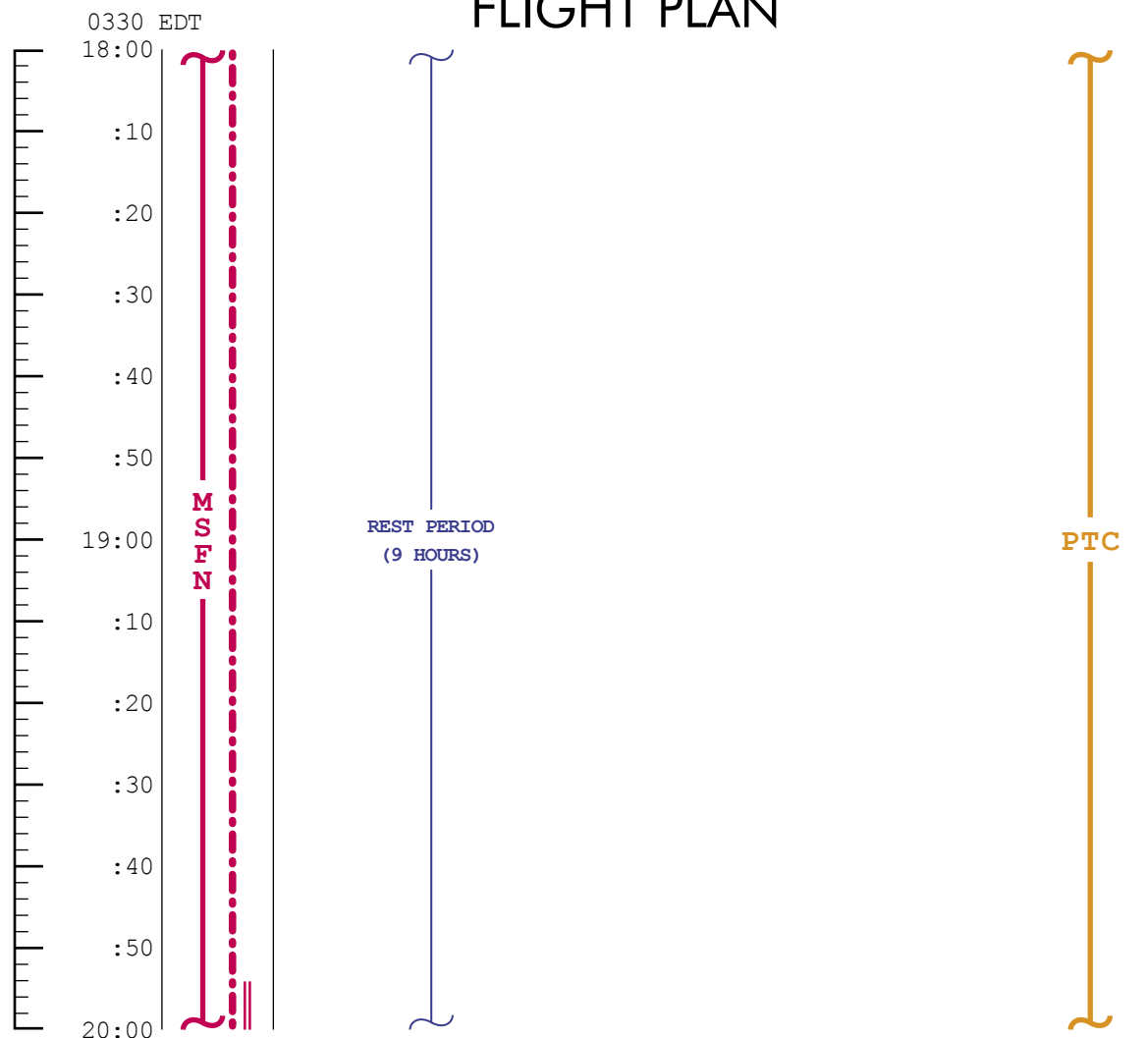

MISSION	EDITION	DATE	TIME	DAY / REV	PAGE
APOLLO 11	FINAL	JULY 1, 1969	18:00 - 20:00	1 / TLC	3-14

MCC-H

# FLIGHT PLAN

NOTES

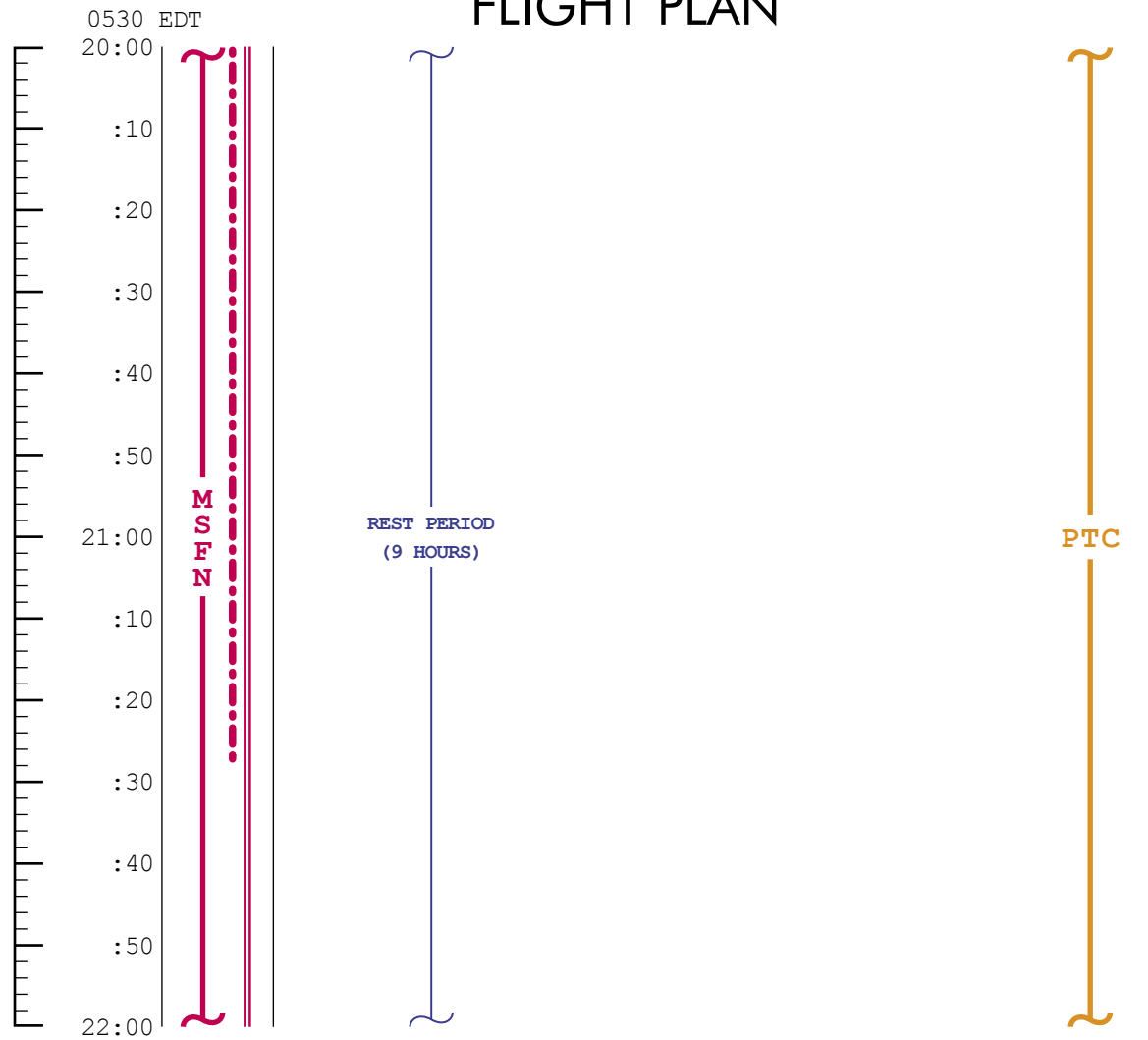

MISSION	EDITION	DATE	TIME	DAY / REV	PAGE
APOLLO 11	FINAL	JULY 1, 1969	20:00 - 22:00	1 / TLC	3-15

**MCC-H**

# FLIGHT PLAN

**NOTES**

0730 EDT

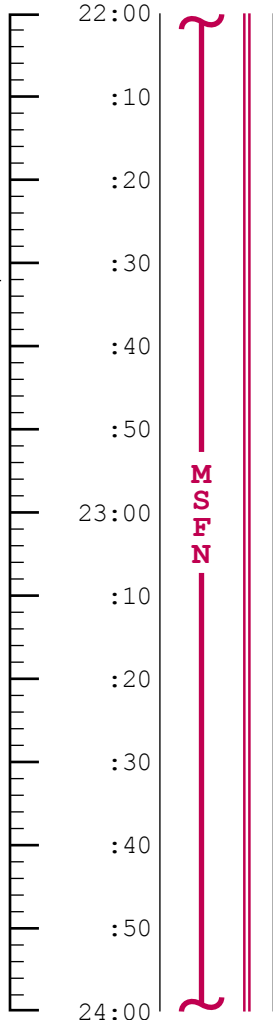

UPDATE  
CONSUMABLES

REST PERIOD  
(9 HOURS)

CO<sub>2</sub> FILTER CHANGE NO.2  
(4 INTO B, STORE 2 IN B5)

EAT PERIOD

POST SLEEP CHECKLIST

CREW STATUS REPORT (SLEEP)  
 CYCLE O<sub>2</sub> & H<sub>2</sub> FANS  
 GDC ALIGN TO IMU  
 REPORT LM/CM ΔP  
 CONSUMABLES UPDATE  
 SELECT NORMAL LUNAR CONFIGURATION  
 EXCEPT:  
 S-BD AUX TAPE - OFF  
 TAPE RCDR FWD - OFF  
 POT H<sub>2</sub>O HTR - ON  
 AUTO RCS JET SELECT (16) - ON

PTC

CONSUMABLE UPDATE  
(Δ FROM NOMINAL)

GET: \_\_\_\_\_  
 RCS TOT \_\_\_\_\_  
 A \_\_\_\_\_  
 B \_\_\_\_\_  
 C \_\_\_\_\_  
 D \_\_\_\_\_  
 H<sub>2</sub> TOT \_\_\_\_\_  
 O<sub>2</sub> TOT \_\_\_\_\_

MISSION	EDITION	DATE	TIME	DAY / REV	PAGE
APOLLO 11	FINAL	JULY 1, 1969	22:00 - 24:00	2 / TLC	3-16

MCC-H

0930 EDT

# FLIGHT PLAN

NOTES

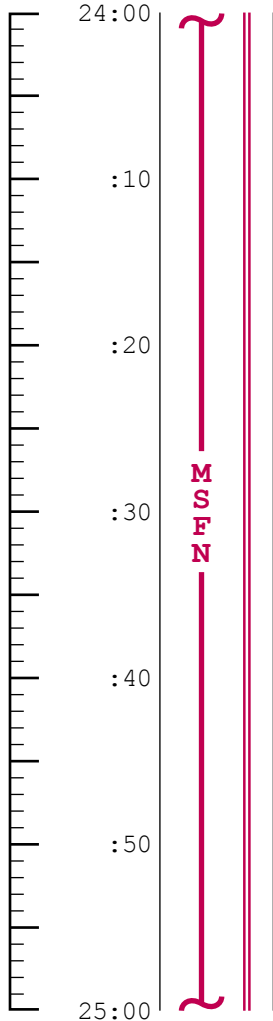

O<sub>2</sub> FUEL CELL PURGE

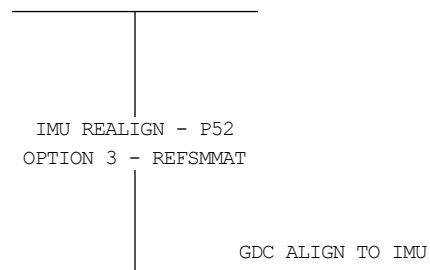

MNVR TO SIGHTING ATT  
 CISELUNAR NAVIGATION P23  
 OPTICS CALIBRATION

1. STAR 01 ENH (R3=00110)

2. STAR 02 ENH (R3=00110)

PTC

REPORT

P52 - (PAD REFSMMAT)

N71: \_ \_ / \_ \_

N05: \_ \_ . \_ \_

N93:

X \_ \_ . \_ \_

Y \_ \_ . \_ \_

Z \_ \_ . \_ \_

GET \_ \_ : \_ \_ : \_ \_

3 MARKS ON EACH STAR  
 INCORPORATE P23 MARK  
 DATA AND UPDATE  
 ONBOARD STATE VECTOR  
 TRN BIAS CALIBRATION  
 REPEATED UNTIL 2 CKS  
 AGREE TO WITHIN 0.003°  
 REPEAT CKS EVERY 30 MIN  
 DURING P23's

MISSION	EDITION	DATE	TIME	DAY / REV	PAGE
APOLLO 11	FINAL	JULY 1, 1969	24:00 - 25:00	2 / TLC	3-17

**MCC-H**

1030 EDT

25:00

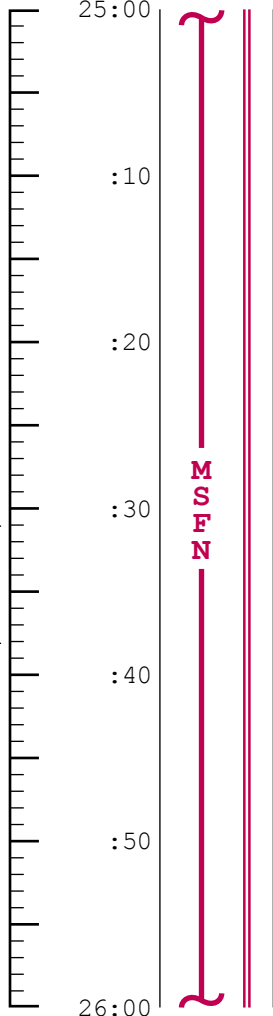

UPLINK CMC

CSM STATE VECTOR  
MCC2 TGT LOAD

UPDATE

MCC2 PAD DATA

# FLIGHT PLAN

3. STAR 44 EFH (R3=00120)

4. STAR 44 EFH (R3=00120)

5. STAR 45 EFH (R3=00120)

V66 - TRANS CSM STATE VECTOR TO LM SLOT

RECORD MCC2 MNVR PAD

**NOTES**

FOV=4°  
GET=26:00

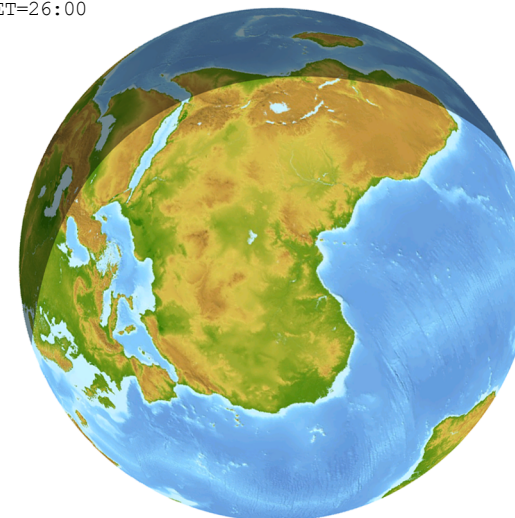

MISSION	EDITION	DATE	TIME	DAY / REV	PAGE
APOLLO 11	FINAL	JULY 1, 1969	25:00 - 26:00	2 / TLC	3-18

MCC  
BURN CHART

	P OR Y RATES	ATT DEVIATION	SHUTDOWN TIME	RESIDUALS
MCC2	10°/SEC TAKEOVER	±10° TAKEOVER	BT +1 SEC	TRIM X AXIS ONLY (UNLESS X > 2 FPS)



**MCC-H**

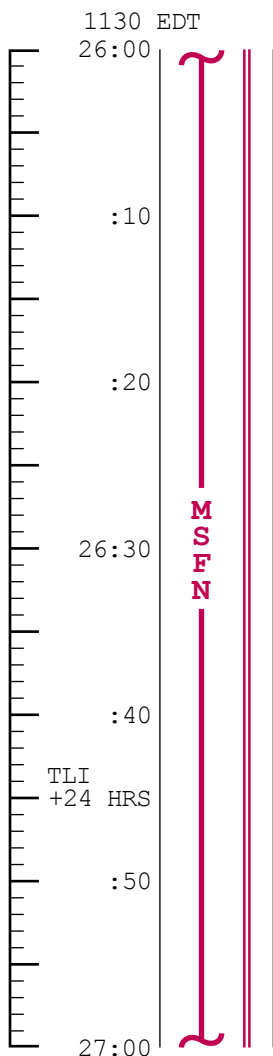

# FLIGHT PLAN

EXT ΔV - P30

SPS/RCS THRUST - P40/41

MNVR TO BURN ATT

SXT STAR CK

EMS ΔV TEST

SM RCS MON CK

GDC ALIGN TO IMU

MCC2 ΔV=NOMINALLY ZERO

SM RCS MON

SPS MON CK

MCC2 BURN STATUS REPORT

V66 - TRANS CSM STATE VECTOR TO LM SLOT

## NOTES

BURN STATUS REPORT				
X	X	<input type="checkbox"/>	•	ATIG
X	X		•	BT
<input type="checkbox"/>			•	V <sub>gx</sub>
TRIM				
X	X	X		R
X	X	X		P
X	X	X		Y
<input type="checkbox"/>			•	V <sub>gx</sub>
<input type="checkbox"/>			•	V <sub>gy</sub>
<input type="checkbox"/>			•	V <sub>gz</sub>
<input type="checkbox"/>			•	ΔV <sub>c</sub>
X	X	X		FUEL
X	X	X		OX
X	X	X		UNBAL

MCC2 WILL BE PERFORMED  
IF 5V WOULD EXCEED  
25 FPS IF DELAYED TO  
MCC3 (LOI -22 HRS)

MISSION	EDITION	DATE	TIME	DAY / REV	PAGE
APOLLO 11	FINAL	JULY 1, 1969	26:00 - 27:00	2 / TLC	3-19

**MCC-H**

UPLINK  
 EARTH HORIZON  
 BIAS ( $\Delta H$ )  
 (IF REQUIRED)

1230 EDT

27:00

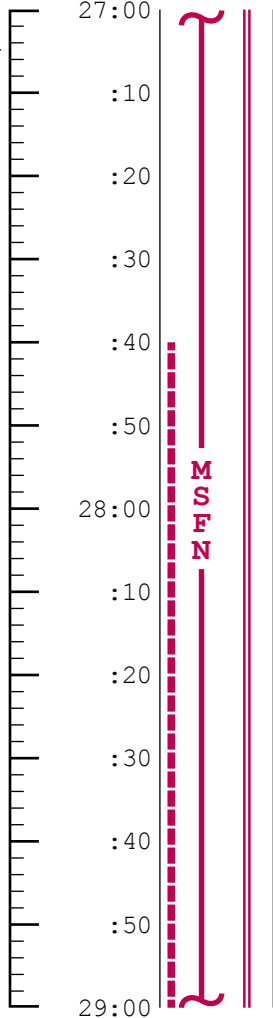

# FLIGHT PLAN

**NOTES**

START PTC  
 P 90° Y 0°

PTC

THE EARTH HORIZON  
 BIAS WILL BE UPDATED  
 TO THE CMC IF THE  
 DIFFERENCE BETWEEN  
 THE SIGHTING  $\Delta H$   
 IS  $\geq 8.3$  KM

PTC ESTABLISHED  
 IN G&N P, Y  
 $\pm 30^\circ$  DB, R RATE  
 OF  $0.3^\circ/\text{SEC}$

MISSION	EDITION	DATE	TIME	DAY / REV	PAGE
APOLLO 11	FINAL	JULY 1, 1969	27:00 - 29:00	2 / TLC	3-20

**MCC-H**

# FLIGHT PLAN

**NOTES**

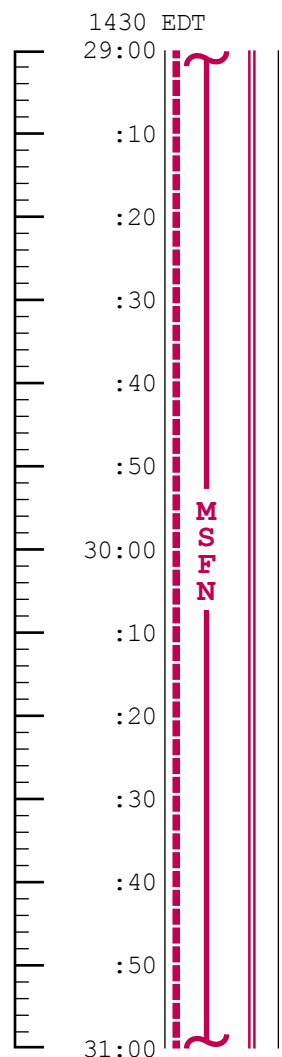

MISSION	EDITION	DATE	TIME	DAY / REV	PAGE
APOLLO 11	FINAL	JULY 1, 1969	29:00 - 31:00	2 / TLC	3-21

**MCC-H**

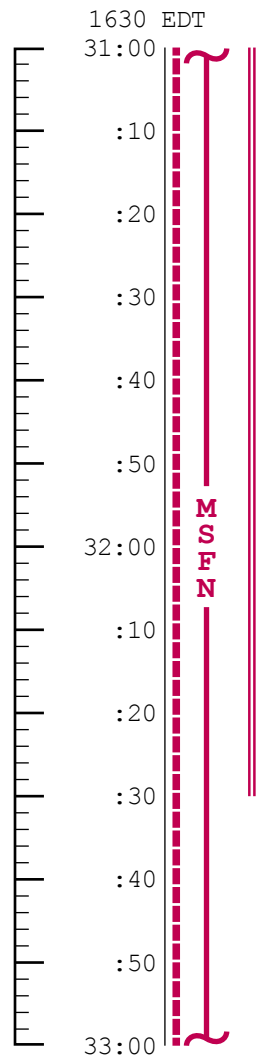

# FLIGHT PLAN

**NOTES**



MISSION	EDITION	DATE	TIME	DAY / REV	PAGE
APOLLO 11	FINAL	JULY 1, 1969	31:00 - 33:00	2 / TLC	3-22

MCC-H

# FLIGHT PLAN

NOTES

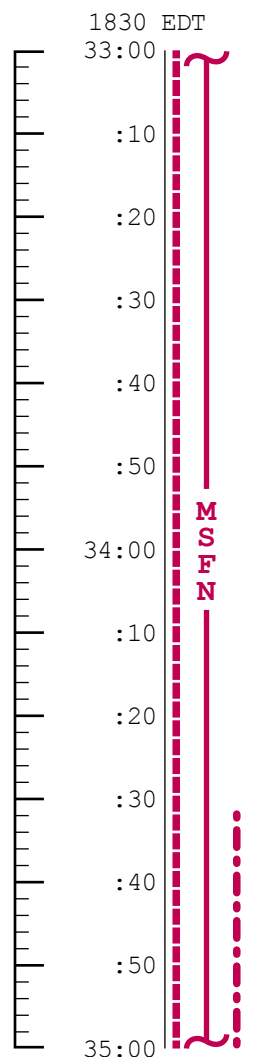

O<sub>2</sub> FUEL CELL PURGE

CO<sub>2</sub> FILTER CHANGE NO.3  
(5 INTO A, STORE 3 IN B5)

MISSION	EDITION	DATE	TIME	DAY / REV	PAGE
APOLLO 11	FINAL	JULY 1, 1969	33:00 - 35:00	2 / TLC	3-23

**MCC-H**

UPDATE

BLOCK DATA

2030 EDT

35:00

:10

:20

:30

:40

:50

36:00

:10

:20

:30

:40

:50

37:00

M  
S  
F  
N

# FLIGHT PLAN

**NOTES**

RECORD BLOCK DATA-  
LOI -5 FLYBY TO  
PRIME CLA

\_\_\_\_\_

EAT PERIOD - ALL

REPORT LM/CM ΔP  
REINITIATE CSM PURGE  
(IF REQUIRED)

NOTE:  
THE LENGTH OF THE SECOND CSM CABIN PURGE  
WILL BE DETERMINED REAL TIME BASED ON THE  
LM LEAK RATE ENSURING LM O<sub>2</sub> PURITY  
REQUIREMENTS ON THE LUNAR SURFACE

PRE SLEEP CHECKLIST

CREW STATUS REPORT (RADIATION, MEDICATION)  
CYCLES O<sub>2</sub> & H<sub>2</sub> FANS  
CHLORINATE POTABLE WATER  
SELECT NORMAL LUNAR CONFIGURATION  
EXCEPT:  
S-BD NORMAL MODE VOICE - OFF  
S-BD AUX TAPE - OFF  
TAPE RCDR FWD - OFF  
GO TO HGA OR CONTINUE OMNI  
OPS PER MSFN  
OMNI OPS  
S-BD ANT OMNI - OMNI  
S-BD ANT OMNI - B  
HI GAIN OPS  
HI GAIN ANT BEAM - NARROW  
HI GAIN ANT TRACK - REACQ  
S-BD ANT - HI GAIN  
VERIFY:  
WASTE MNGT OVBD DRAIN - OFF  
WASTE STOW VENT VLV - CLOSED  
EMERG CABIN PRESS VLV - BOTH  
SURGE TK O<sub>2</sub> VLV - ON  
REPRESS PACK O<sub>2</sub> VLV - ON  
LM TUNNEL VENT VLV - LM/CM ΔP  
POT H<sub>2</sub>O HTR - OFF  
AUTO RCS JET SELECT (16) - OFF

ONBOARD READOUT

BAT C \_\_\_\_\_  
PYRO BAT A \_\_\_\_\_  
PYRO BAT B \_\_\_\_\_  
RCS A \_\_\_\_\_  
B \_\_\_\_\_  
C \_\_\_\_\_  
D \_\_\_\_\_  
DC IND SEL TO MNA OR MNB

MISSION	EDITION	DATE	TIME	DAY / REV	PAGE
APOLLO 11	FINAL	JULY 1, 1969	35:00 - 37:00	2 / TLC	3-24

**MCC-H**

# FLIGHT PLAN

**NOTES**

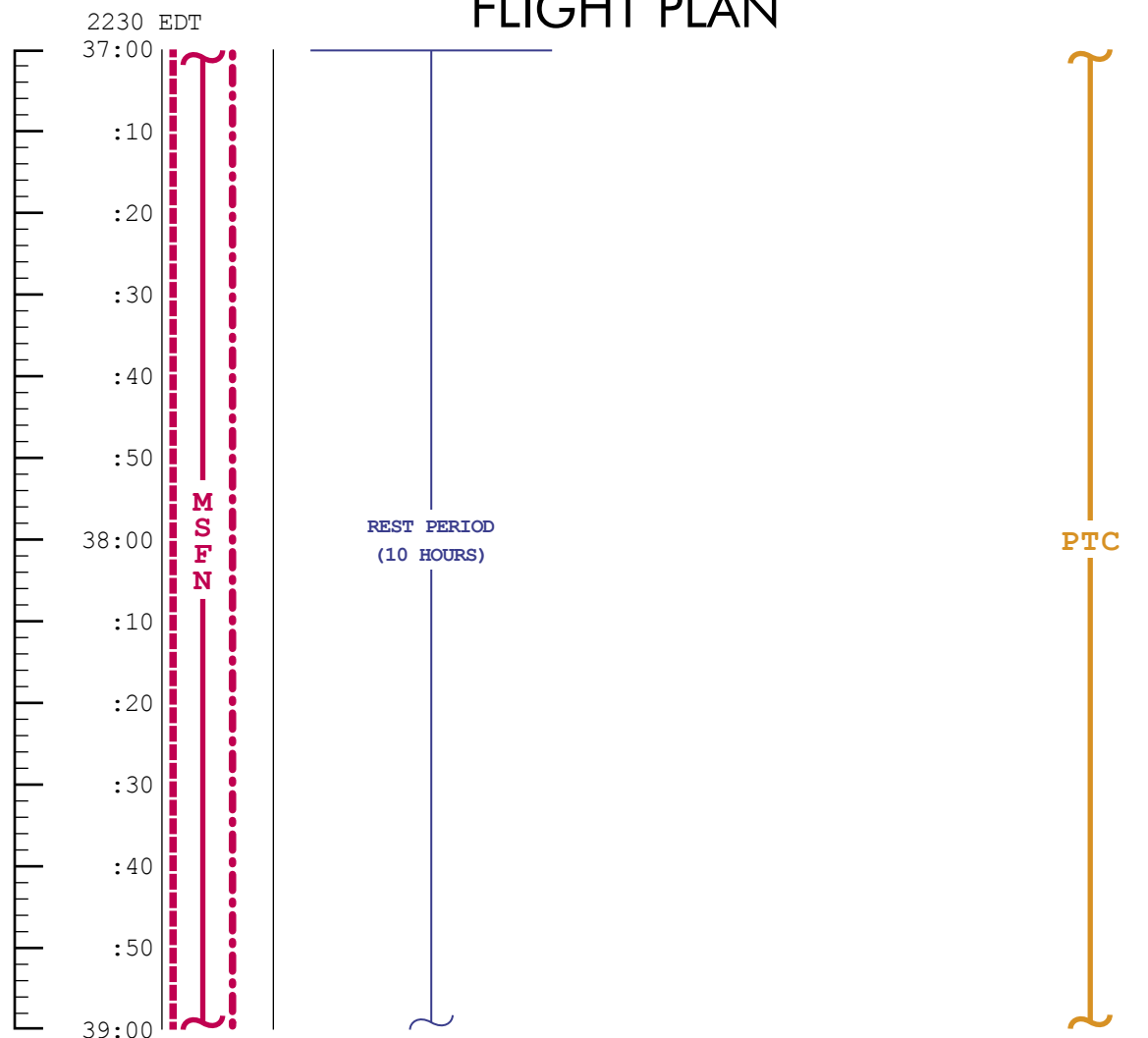

DURING REST PERIOD  
2 CREWMEN IN REST  
STATION, 1 IN LEFT  
COUCH

MISSION	EDITION	DATE	TIME	DAY / REV	PAGE
APOLLO 11	FINAL	JULY 1, 1969	37:00 - 39:00	2 / TLC	3-25

MCC-H

# FLIGHT PLAN

NOTES

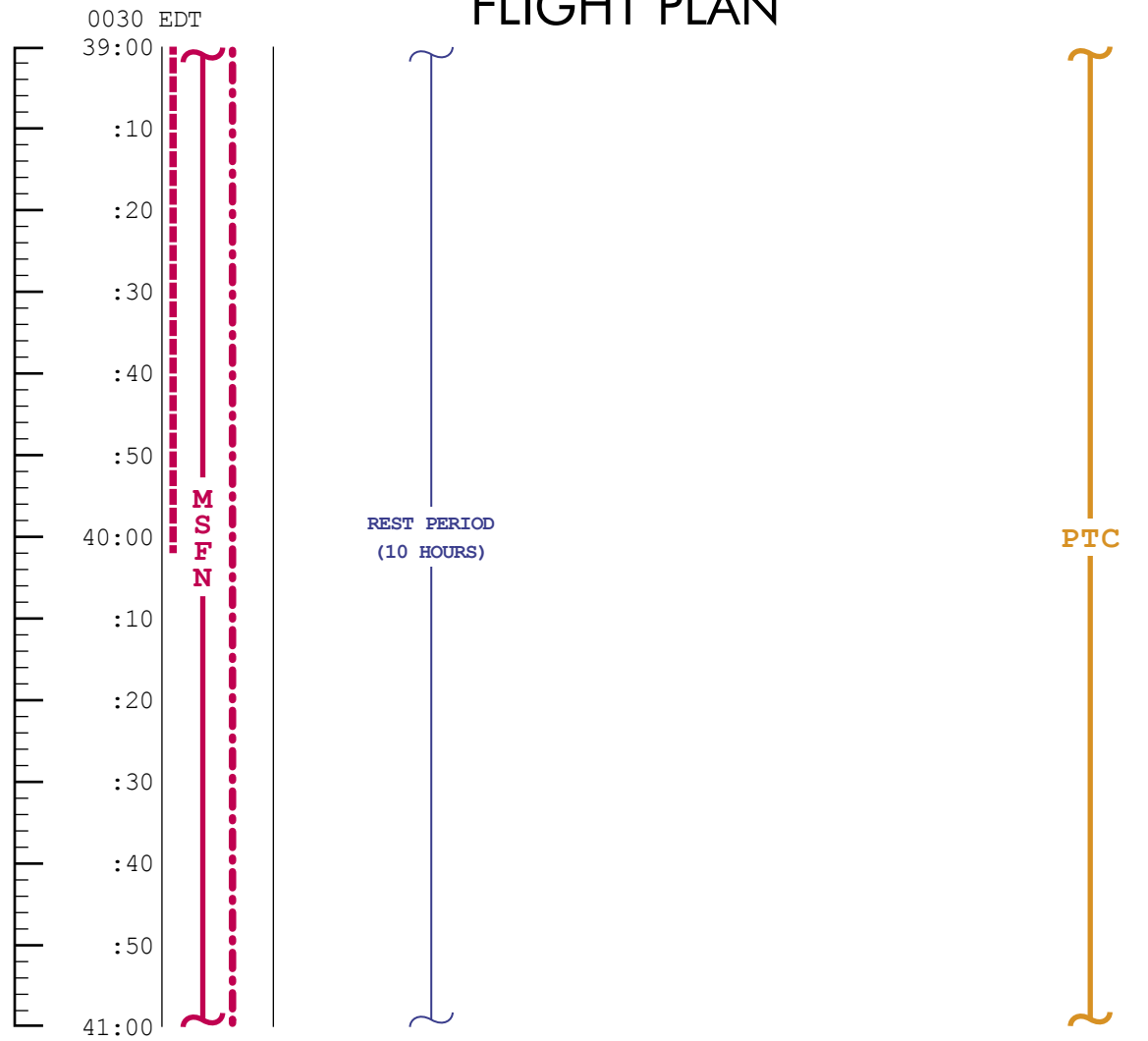

MISSION	EDITION	DATE	TIME	DAY / REV	PAGE
APOLLO 11	FINAL	JULY 1, 1969	39:00 - 41:00	2 / TLC	3-26



**MCC-H**

# FLIGHT PLAN

**NOTES**

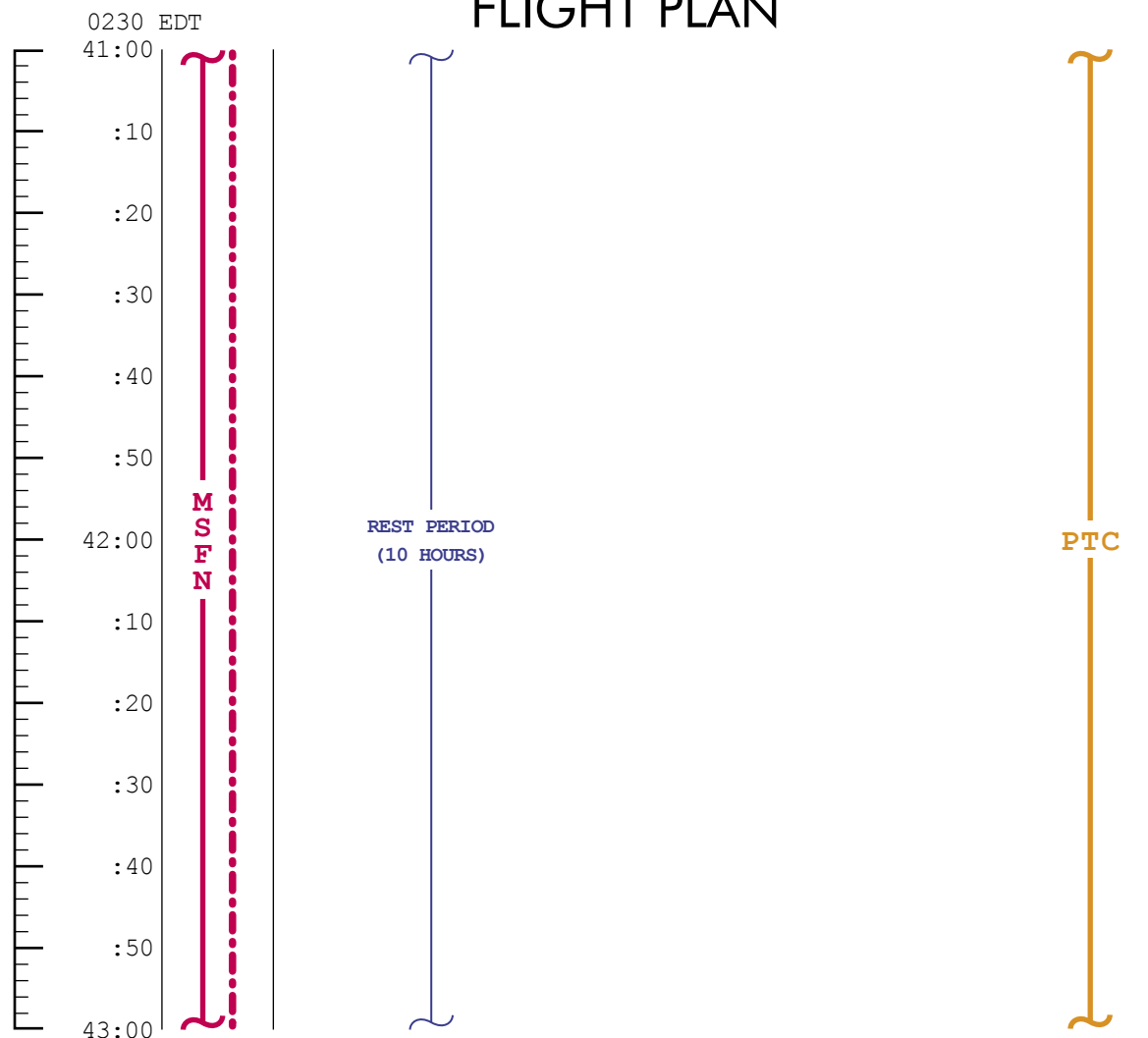

MISSION	EDITION	DATE	TIME	DAY / REV	PAGE
APOLLO 11	FINAL	JULY 1, 1969	41:00 - 43:00	2 / TLC	3-27

MCC-H

# FLIGHT PLAN

NOTES

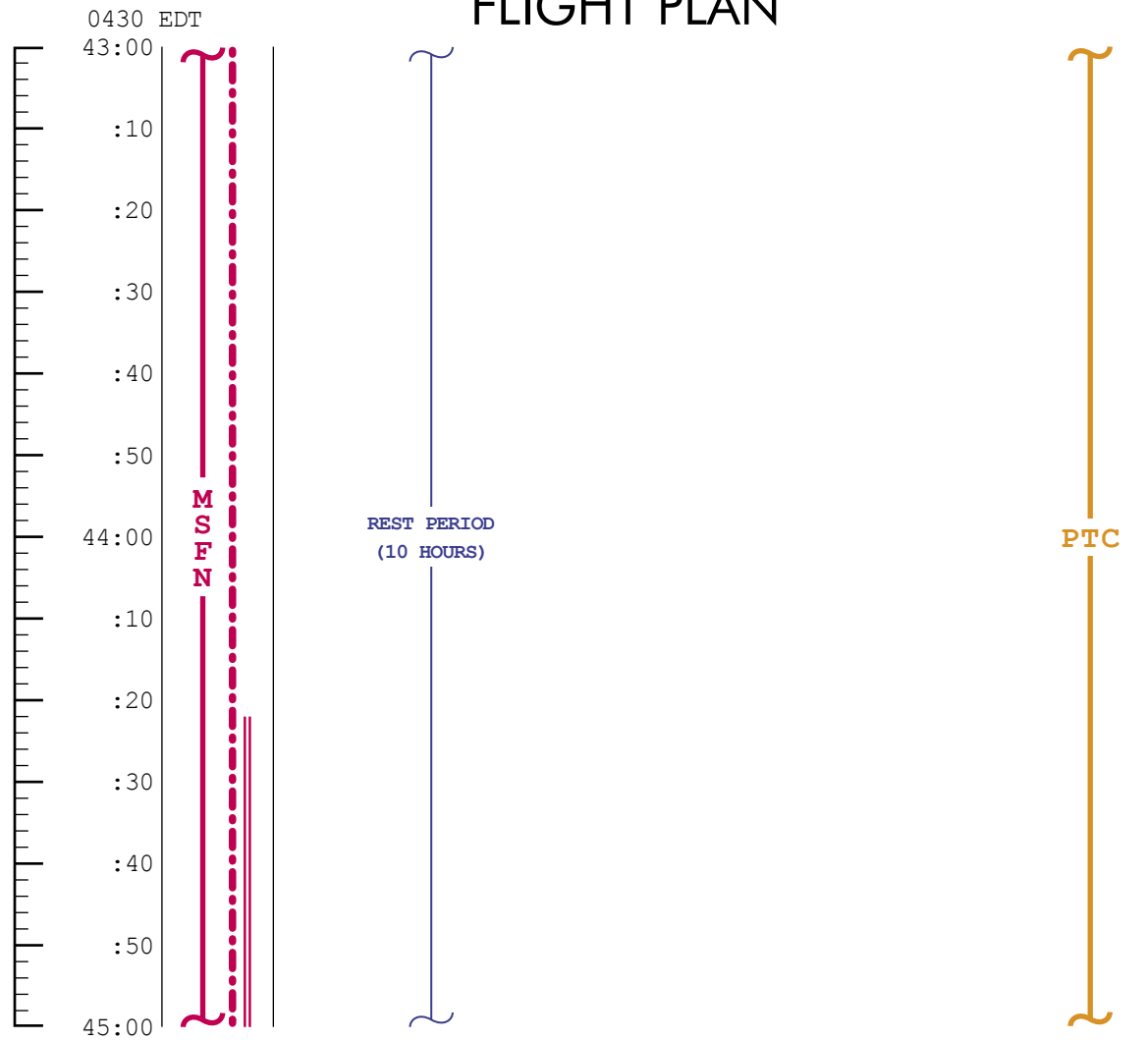

MISSION	EDITION	DATE	TIME	DAY / REV	PAGE
APOLLO 11	FINAL	JULY 1, 1969	43:00 - 45:00	2 / TLC	3-28

**MCC-H**

# FLIGHT PLAN

**NOTES**

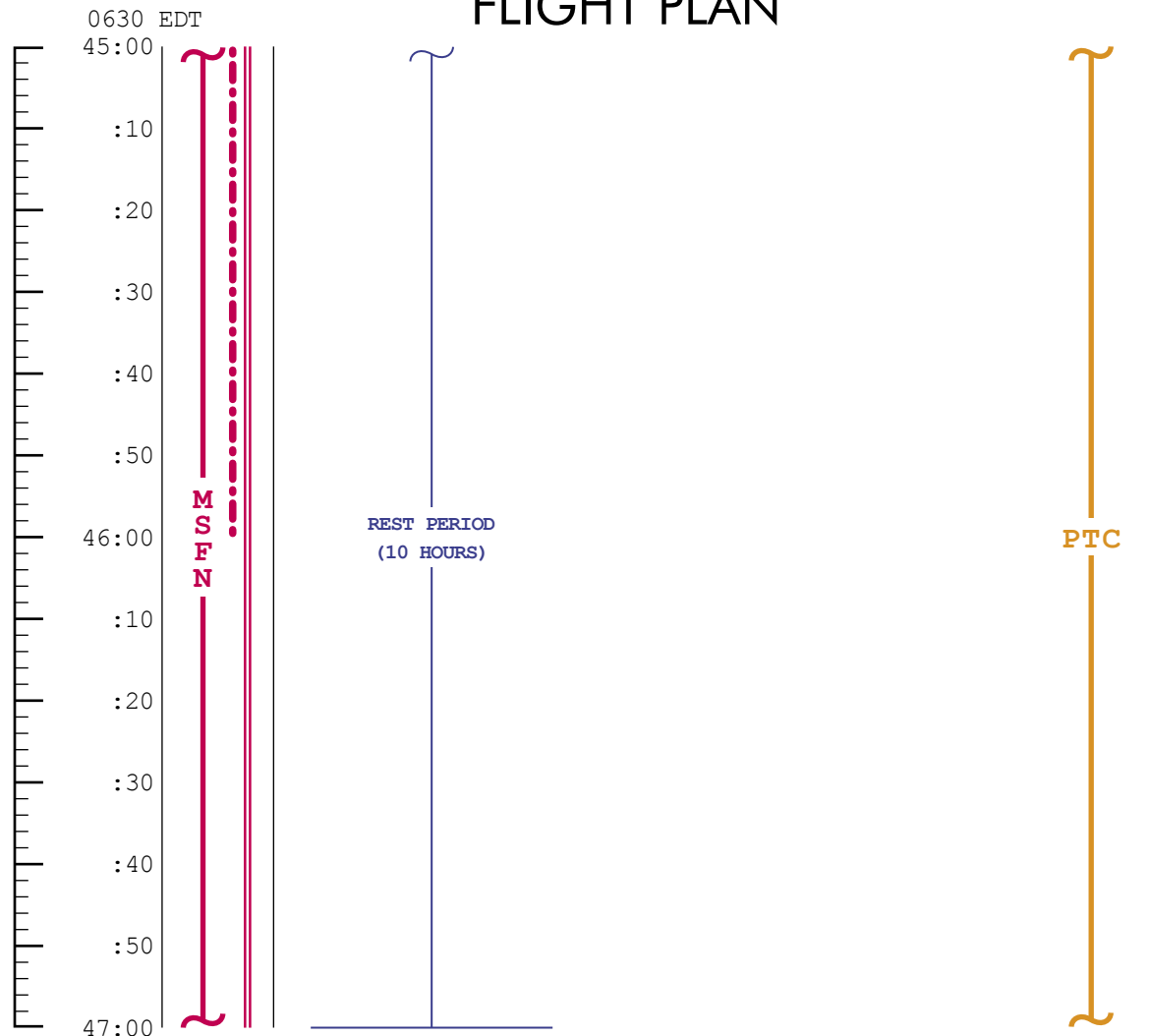

MISSION	EDITION	DATE	TIME	DAY / REV	PAGE
APOLLO 11	FINAL	JULY 1, 1969	45:00 - 47:00	2 / TLC	3-29

MCC-H

# FLIGHT PLAN

NOTES

0830 EDT

47:00

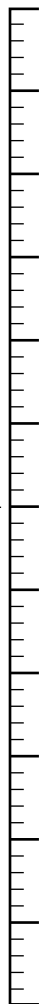

M  
S  
F  
N

EAT PERIOD - ALL

CO<sub>2</sub> FILTER CHANGE NO.4  
(6 INTO B, STORE 4 IN B5)

POST SLEEP CHECKLIST

CREW STATUS REPORT (SLEEP)  
 CYCLE O<sub>2</sub> & H<sub>2</sub> FANS  
 GDC ALIGN TO IMU  
 CONSUMABLES UPDATE  
 SELECT NORMAL LUNAR CONFIGURATION  
 EXCEPT:  
 S-BD AUX TAPE - OFF  
 TAPE RCDR FWD - OFF  
 POT H<sub>2</sub>O HTR - ON  
 AUTO RCS JET SELECT (16) - ON

BATTERY CHARGE, BATTERY B

PTC

UPDATE

CONSUMABLES

48:00

:10

:20

:30

:40

:50

49:00

CONSUMABLE UPDATE  
(Δ FROM NOMINAL)

GET: \_\_\_\_\_

RCS TOT \_\_\_\_\_

A \_\_\_\_\_

B \_\_\_\_\_

C \_\_\_\_\_

D \_\_\_\_\_

H<sub>2</sub> TOT \_\_\_\_\_

O<sub>2</sub> TOT \_\_\_\_\_

MISSION	EDITION	DATE	TIME	DAY / REV	PAGE
APOLLO 11	FINAL	JULY 1, 1969	47:00 - 49:00	3 / TLC	3-30

**MCC-H**

# FLIGHT PLAN

**NOTES**

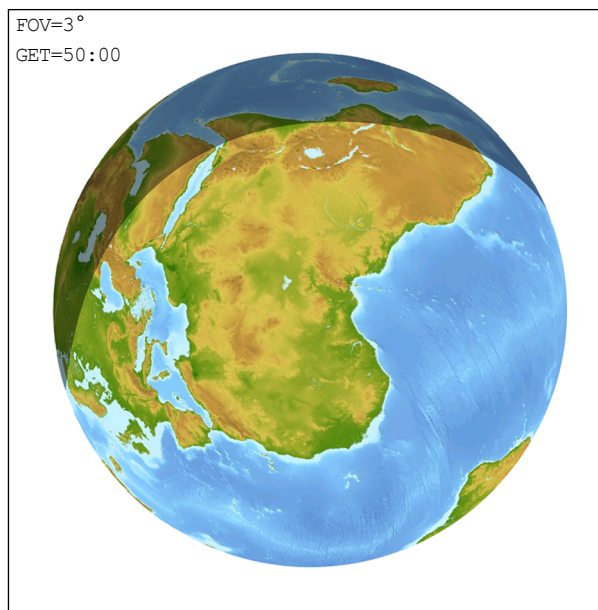
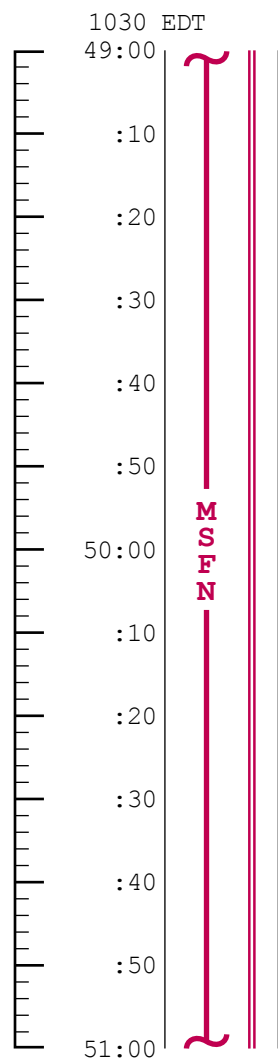

MISSION	EDITION	DATE	TIME	DAY / REV	PAGE
APOLLO 11	FINAL	JULY 1, 1969	49:00 - 51:00	3 / TLC	3-31

**MCC-H**

1230 EDT

# FLIGHT PLAN

**NOTES**

UPLINK

CSM STATE VECTOR  
MCC3 TGT LOAD

UPDATE

MCC3 MNVR PAD

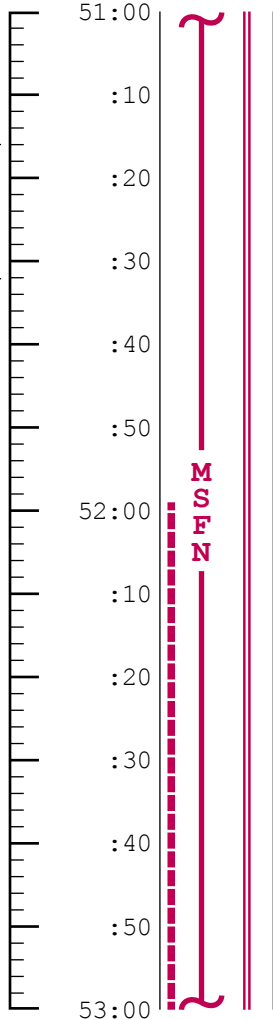

V66 - TRANSFER CSM STATE VECTOR TO LM SLOT

RECORD MCC3 MNVR PAD  
H<sub>2</sub> PURGE LINE HTRS-ON

O<sub>2</sub> & H<sub>2</sub> FUEL CELL PURGE

EAT PERIOD - ALL

**PTC**

MISSION	EDITION	DATE	TIME	DAY / REV	PAGE
APOLLO 11	FINAL	JULY 1, 1969	51:00 - 53:00	3 / TLC	3-32

THIS PAGE INTENTIONALLY LEFT BLANK.

MCC  
BURN CHART

	P OR Y RATES	ATT DEVIATION	SHUTDOWN TIME	RESIDUALS
MCC3	10°/SEC TAKEOVER	±10° TAKEOVER	BT +1 SEC	TRIM X AXIS ONLY (UNLESS X > 2 FPS)



MCC-H

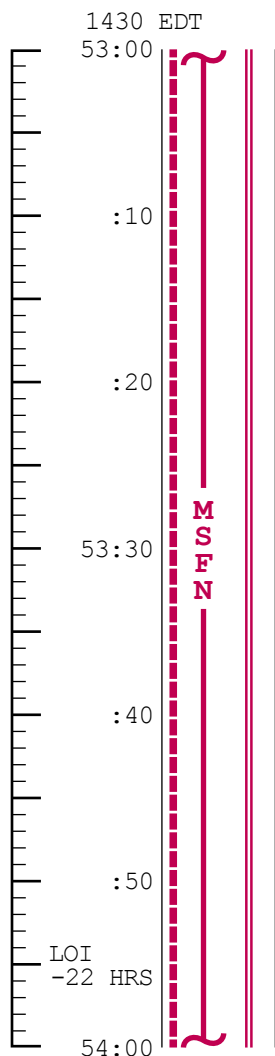

# FLIGHT PLAN

IMU REALIGN - P52  
OPTION 3 - REFSMMAT

EXT ΔV - P30

SPS/RCS THRUST - P40/41

MNVR TO BURN ATT

SXT STAR CK (STOW OPTICS)

EMS ΔV TEST

SM RCS MON CK

GDC ALIGN TO IMU

MCC3 ΔV=NOMINALLY ZERO

SM RCS MON

SPS MON CK

BURN STATUS REPORT				
X	X	<input type="checkbox"/>	•	ΔTIG
X	X		•	BT
<input type="checkbox"/>			•	V <sub>gx</sub>
TRIM				
X	X	X		R
X	X	X		P
X	X	X		Y
<input type="checkbox"/>			•	V <sub>gx</sub>
<input type="checkbox"/>			•	V <sub>gy</sub>
<input type="checkbox"/>			•	V <sub>gz</sub>
<input type="checkbox"/>			•	ΔV <sub>c</sub>
X	X	X		FUEL
X	X	X		OX
X	X	X		UNBAL

## NOTES

P52 - (PAD REFSMMAT)  
N71: \_ \_ \_ / \_ \_ \_  
N05: \_ \_ \_ . \_ \_ \_  
N93:  
X \_ \_ . \_ \_ \_ \_  
Y \_ \_ . \_ \_ \_ \_  
Z \_ \_ . \_ \_ \_ \_  
GET \_ \_ \_ : \_ \_ : \_ \_ \_

MCC3 WILL BE EXECUTED  
IF ΔV >3 FPS  
AND IF LOI1 CANNOT BE  
TARGETED TO CORRECT  
THE TLC DISPERSIONS

MISSION	EDITION	DATE	TIME	DAY / REV	PAGE
APOLLO 11	FINAL	JULY 1, 1969	53:00 - 54:00	3 / TLC	3-33

MCC-H

# FLIGHT PLAN

NOTES

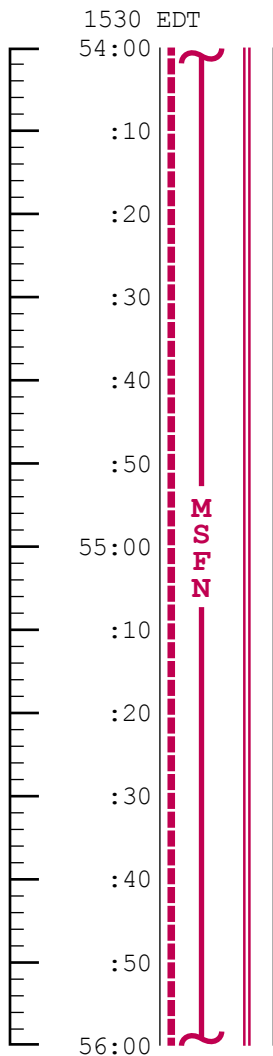

MCC3 BURN STATUS REPORT  
V66 - TRANS CSM STATE VECTOR TO LM SLOT

T  
START PTC  
P 90° Y 0°

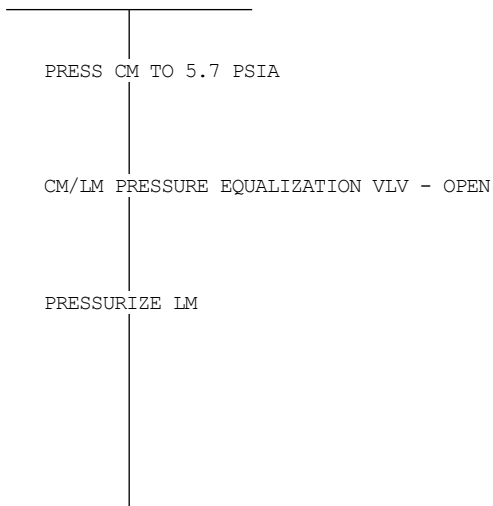

PTC

MISSION	EDITION	DATE	TIME	DAY / REV	PAGE
APOLLO 11	FINAL	JULY 1, 1969	54:00 - 56:00	3 / TLC	3-34

# FLIGHT PLAN

## CSM CMP

CLEAR TUNNEL OF CM HATCH  
 INSPECT TUNNEL &  
 DOCKING LATCHES  
 REMOVE PROBE & DROGUE

TEMPORARILY STOW PROBE  
 AND DROGUE

CONFIGURE DSE TO RECORD  
 LM DATA

DUMP DSE (LM DATA)

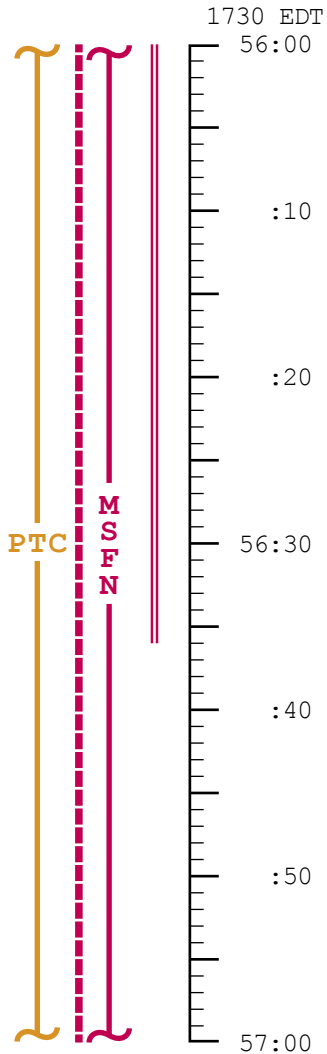

## CDR

## LM

## LMP

## MCC-H

		OPEN LM HATCH RECORD ROLL CAL ANGLE IVT TO LM	
		ACT VHF B FOR DATA XMIT FOR 5 MINUTES	
IVT TO LM		ASSIST CDR	
LM FAMILIARIZATION		LM FAMILIARIZATION	VERIFY OPERATION OF LM 16mm CAMERA

MISSION	EDITION	DATE	TIME	DAY / REV	PAGE
APOLLO 11	FINAL	JULY 1, 1969	56:00 - 57:00	3 / TLC	3-35

**CSM  
CMP**

# FLIGHT PLAN

**MCC-H**

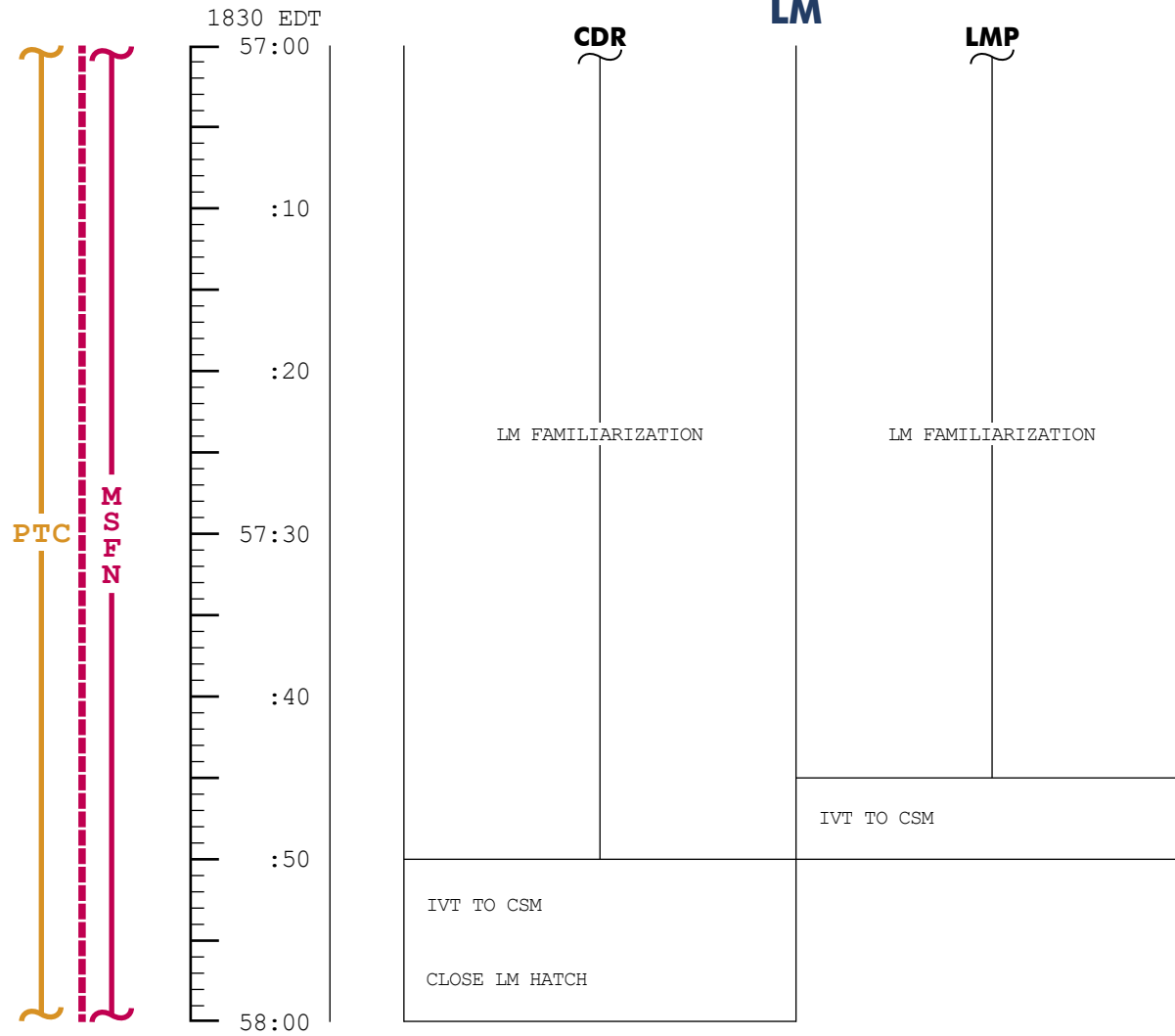

MISSION	EDITION	DATE	TIME	DAY / REV	PAGE
APOLLO 11	FINAL	JULY 1, 1969	57:00 - 58:00	3 / TLC	3-36

MCC-H

# FLIGHT PLAN

## NOTES

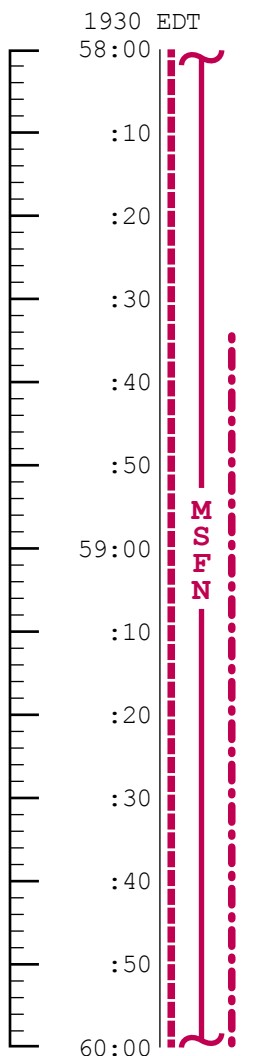

INSTALL PROBE AND DROGUE  
 INSTALL CM HATCH  
 LM TUNNEL VENT VALVE - LM/CM ΔP

CO<sub>2</sub> FILTER CHANGE NO.5  
 (7 INTO A, STORE 5 IN B6)

EAT PERIOD - ALL



180,000 NM from EARTH

ONBOARD READOUT

BAT C \_\_\_\_\_

PYRO BAT A \_\_\_\_\_

PYRO BAT B \_\_\_\_\_

RCS A \_\_\_\_\_

      B \_\_\_\_\_

      C \_\_\_\_\_

      D \_\_\_\_\_

DC IND SEL TO MNA OR MNB

MISSION	EDITION	DATE	TIME	DAY / REV	PAGE
APOLLO 11	FINAL	JULY 1, 1969	58:00 - 60:00	3 / TLC	3-37

MCC-H

# FLIGHT PLAN

NOTES

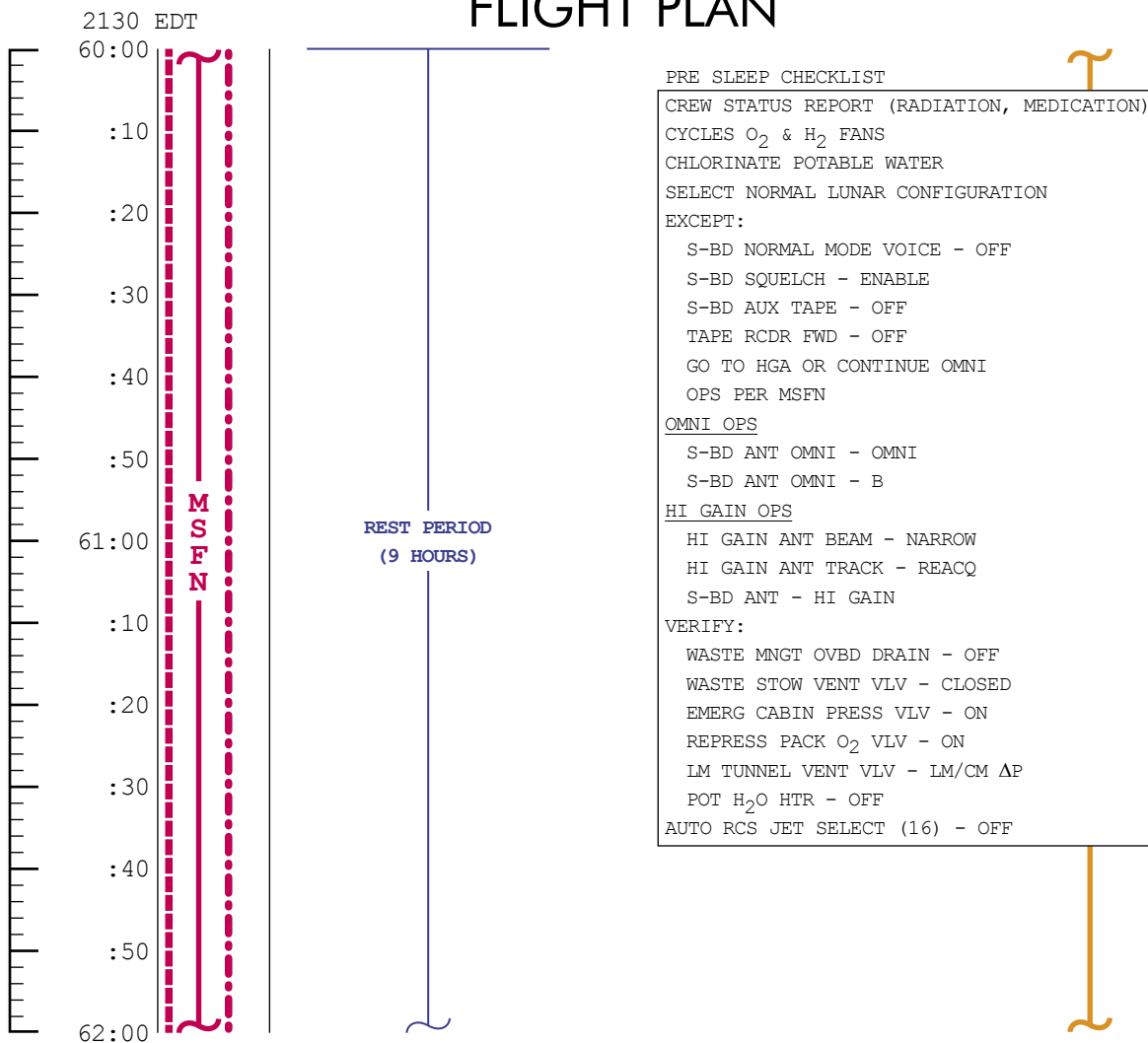

PRE SLEEP CHECKLIST

CREW STATUS REPORT (RADIATION, MEDICATION)

CYCLES O<sub>2</sub> & H<sub>2</sub> FANS

CHLORINATE POTABLE WATER

SELECT NORMAL LUNAR CONFIGURATION

EXCEPT:

- S-BD NORMAL MODE VOICE - OFF
- S-BD SQUELCH - ENABLE
- S-BD AUX TAPE - OFF
- TAPE RCDR FWD - OFF
- GO TO HGA OR CONTINUE OMNI
- OPS PER MSFN

OMNI OPS

- S-BD ANT OMNI - OMNI
- S-BD ANT OMNI - B

HI GAIN OPS

- HI GAIN ANT BEAM - NARROW
- HI GAIN ANT TRACK - REACQ
- S-BD ANT - HI GAIN

VERIFY:

- WASTE MNGT OVBD DRAIN - OFF
- WASTE STOW VENT VLV - CLOSED
- EMERG CABIN PRESS VLV - ON
- REPRESS PACK O<sub>2</sub> VLV - ON
- LM TUNNEL VENT VLV - LM/CM ΔP
- POT H<sub>2</sub>O HTR - OFF
- AUTO RCS JET SELECT (16) - OFF

DURING REST PERIOD  
2 CREWMEN IN REST  
STATION, 1 IN LEFT  
COUCH

MISSION	EDITION	DATE	TIME	DAY / REV	PAGE
APOLLO 11	FINAL	JULY 1, 1969	60:00 - 62:00	3 / TLC	3-38

**MCC-H**

# FLIGHT PLAN

**NOTES**

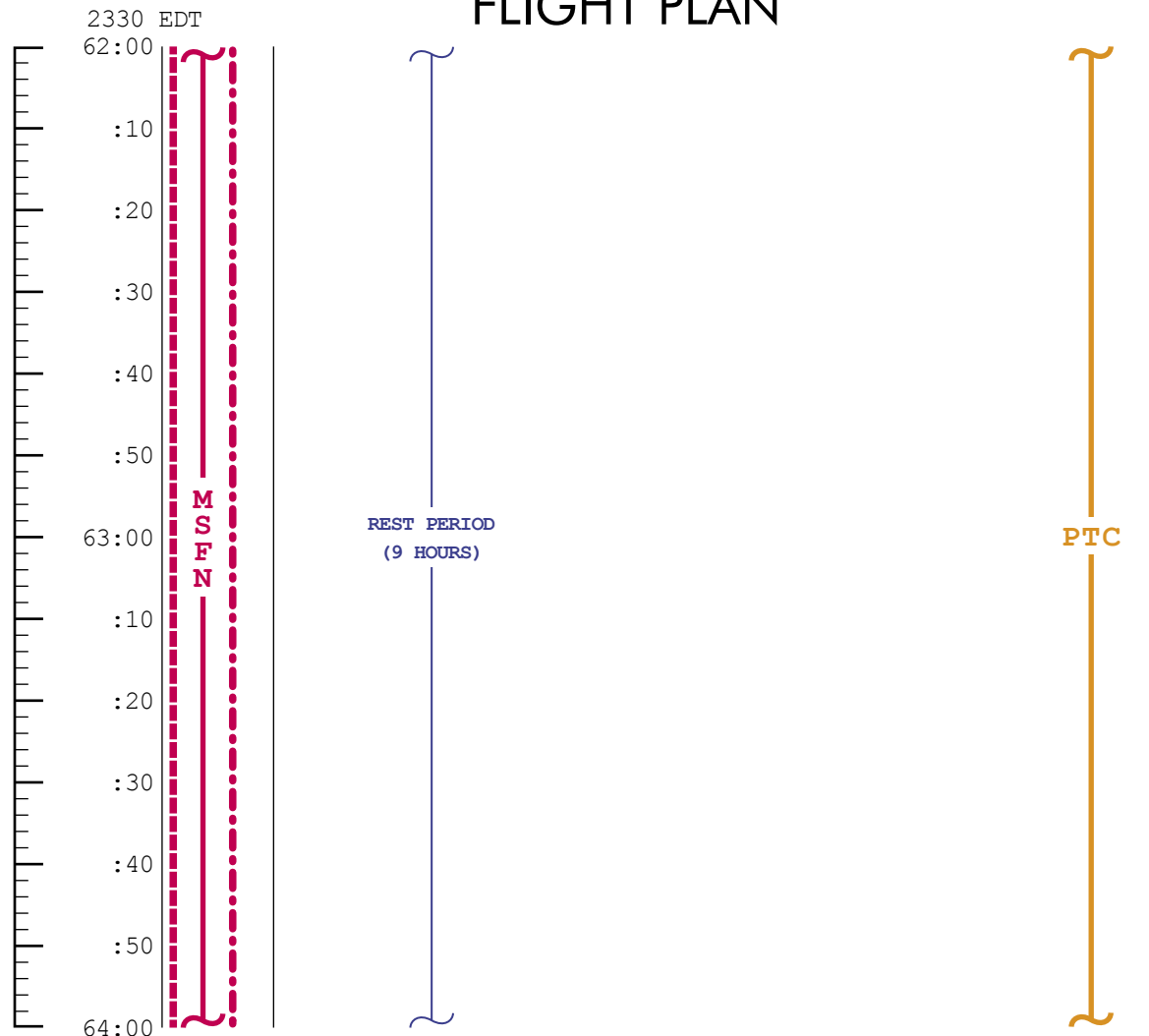

MISSION	EDITION	DATE	TIME	DAY / REV	PAGE
APOLLO 11	FINAL	JULY 1, 1969	62:00 - 64:00	3 / TLC	3-39

MCC-H

# FLIGHT PLAN

NOTES

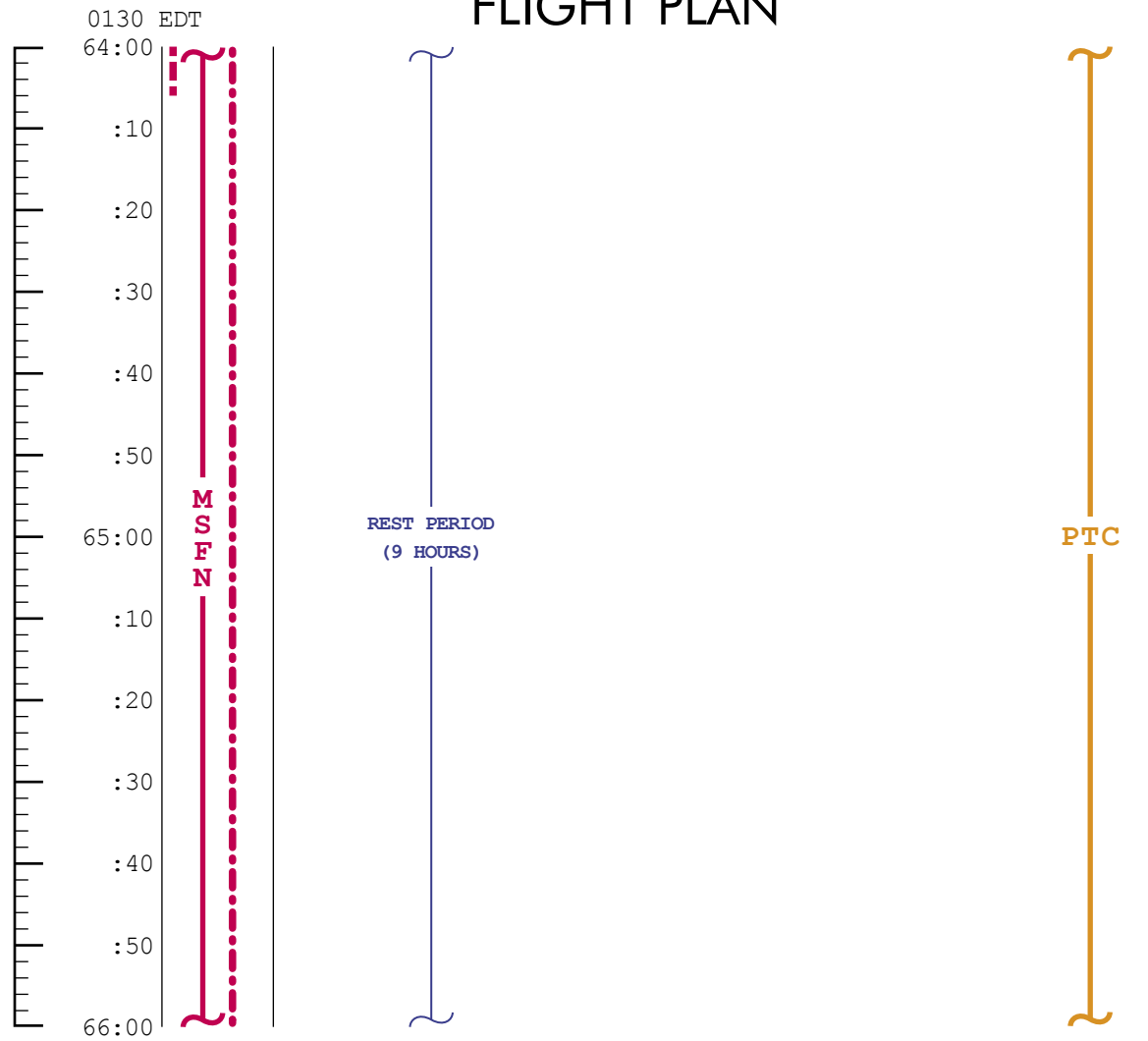

MISSION	EDITION	DATE	TIME	DAY / REV	PAGE
APOLLO 11	FINAL	JULY 1, 1969	64:00 - 66:00	3 / TLC	3-40



**MCC-H**

# FLIGHT PLAN

**NOTES**

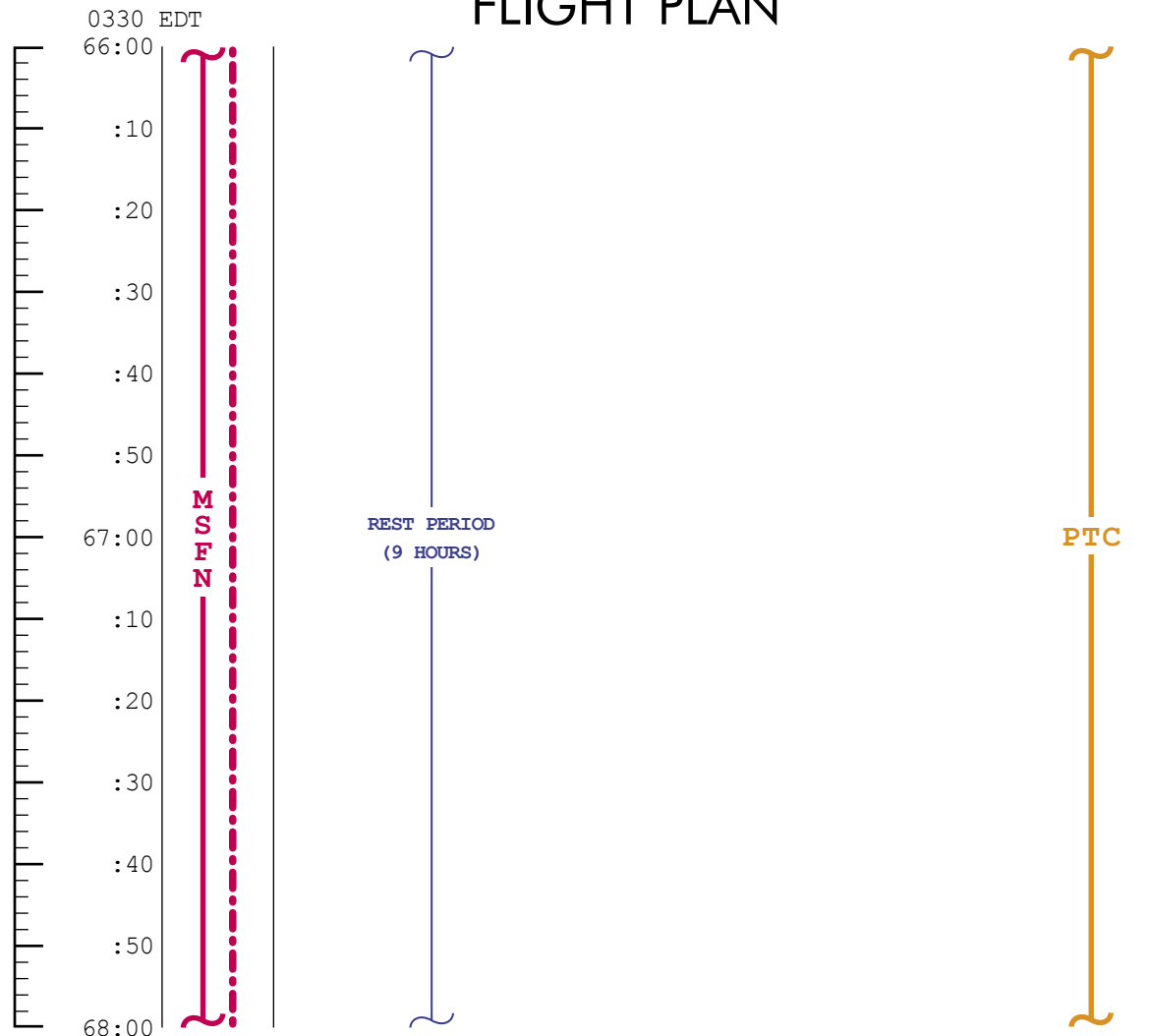

MISSION	EDITION	DATE	TIME	DAY / REV	PAGE
APOLLO 11	FINAL	JULY 1, 1969	66:00 - 68:00	3 / TLC	3-41

MCC-H

# FLIGHT PLAN

NOTES

0530 EDT

68:00

:10

:20

:30

:40

:50

69:00

:10

:20

:30

:40

:50

70:00



REST PERIOD  
(9 HOURS)

O<sub>2</sub> FUEL CELL PURGE

EAT PERIOD - ALL



### POST SLEEP CHECKLIST

- CREW STATUS REPORT (SLEEP)
- CYCLE O<sub>2</sub> & H<sub>2</sub> FANS
- GDC ALIGN TO IMU
- CONSUMABLES UPDATE
- SELECT NORMAL LUNAR CONFIGURATION
- EXCEPT:
  - S-BD AUX TAPE - OFF
  - TAPE RCDR FWD - OFF
  - POT H<sub>2</sub>O HTR - ON
  - AUTO RCS JET SELECT (16) - ON

CONSUMABLES REPORT  
(Δ FROM NOMINAL)

GET: \_\_\_\_\_

RCS TOT \_\_\_\_\_

A \_\_\_\_\_

B \_\_\_\_\_

C \_\_\_\_\_

D \_\_\_\_\_

H<sub>2</sub> TOT \_\_\_\_\_

O<sub>2</sub> TOT \_\_\_\_\_

V66 - TRANS CSM STATE VECTOR TO LM SLOT  
RECORD MCC4 MNVR PAD

UNSTOW OPTICS

### UPLINK CMC

- CSM STATE VECTOR
- MCC4 TGT LOAD
- DESIRED ORIENTATION  
(LDG SITE)

### UPDATE

- MCC4 MNVR PAD

MISSION	EDITION	DATE	TIME	DAY / REV	PAGE
APOLLO 11	FINAL	JULY 1, 1969	68:00 - 70:00	3 / TLC	3-42

THIS PAGE INTENTIONALLY LEFT BLANK.

MCC  
BURN CHART

	P OR Y RATES	ATT DEVIATION	SHUTDOWN TIME	RESIDUALS
MCC4	10°/SEC TAKEOVER	±10° TAKEOVER	BT +1 SEC	TRIM X AXIS ONLY (UNLESS X > 2 FPS)

**MCC-H**

UPDATE

BLOCK DATA

0730 EDT

70:00

:10

:20

70:30

:40

:50

LOI

-5 HRS

70:55

71:00



# FLIGHT PLAN

IMU REALIGN - P52  
OPTION 1 - PREFERRED

EXT ΔV - P30

SPS/RCS THRUST - P40/41

MNVR TO BURN ATT

SXT STAR CK

EMS ΔV TEST

SM RCS MON CK

GDC ALIGN TO IMU

SM RCS MON CK

MCC4 ΔV=NOMINALLY ZERO

RECORD BLOCK DATA-  
PC +2 HRS FAST  
RETURN TO ANY CLA

BURN STATUS REPORT				
X	X	<input type="checkbox"/>	•	ΔTIG
X	X		•	BT
<input type="checkbox"/>			•	V <sub>gx</sub>
TRIM				
X	X	X		R
X	X	X		P
X	X	X		Y
<input type="checkbox"/>			•	V <sub>gx</sub>
<input type="checkbox"/>			•	V <sub>gy</sub>
<input type="checkbox"/>			•	V <sub>gz</sub>
<input type="checkbox"/>			•	ΔV <sub>C</sub>
X	X	X		FUEL
X	X	X		OX
X	X	X		UNBAL

**NOTES**

REPORT

P52 - (LDG SITE REFSMMAT)

N71: \_ \_ \_ / \_ \_ \_

N05: \_ \_ \_ . \_ \_ \_

N93:

X \_ \_ . \_ \_ \_

Y \_ \_ . \_ \_ \_

Z \_ \_ . \_ \_ \_

GET \_ \_ \_ : \_ \_ : \_ \_ \_

MCC4 WILL BE EXECUTED  
ONLY IF LOI<sub>1</sub> CANNOT BE  
TARGETED TO CORRECT  
THE MCC3 DISPERSIONS

MISSION	EDITION	DATE	TIME	DAY / REV	PAGE
APOLLO 11	FINAL	JULY 1, 1969	70:00 - 71:00	3 / TLC	3-43

**MCC-H**

0830 EDT

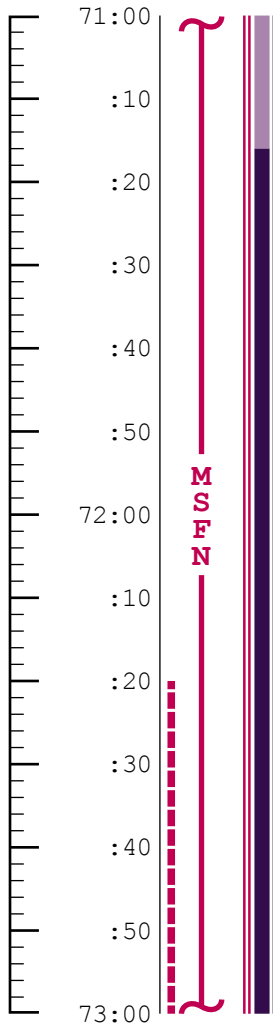

# FLIGHT PLAN

SPS MON CK  
MCC4 BURN STATUS REPORT  
V66 - TRANS CSM STATE VECTOR TO LM SLOT

CO<sub>2</sub> FILTER CHANGE NO.6  
(8 INTO B, STORE 6 IN B6)

PRE-LOI ECS REDUNDANT COMPONENT CK  
ACTIVATE PRIMARY EVAPORATOR

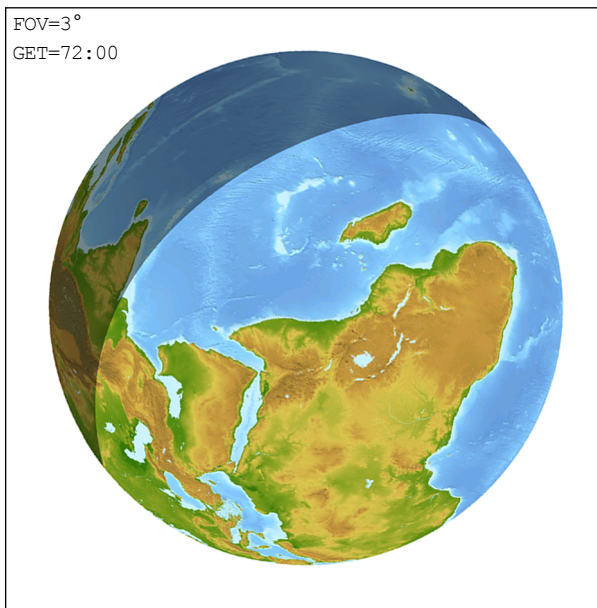

**NOTES**

MISSION	EDITION	DATE	TIME	DAY / REV	PAGE
APOLLO 11	FINAL	JULY 1, 1969	71:00 - 73:00	4 / TLC	3-44

**MCC-H**

UPLINK CMC  
 CSM STATE VECTOR  
 LOI<sub>1</sub> TGT LOAD

UPDATE CSM  
 LOI<sub>1</sub> MNVR PAD

1030 EDT

73:00

73:30

73:52

74:00

M  
S  
F  
N

# FLIGHT PLAN

V66 - TRANSFER CSM STATE VECTOR TO LM SLOT

COPY LOI<sub>1</sub> P30 MANEUVER PAD

IMU REALIGN - P52  
 AND DRIFT CK  
 OPTION 3 - REFSMMAT

COPY BLOCK DATA (TEI<sub>1</sub> & TEI<sub>4</sub>)

**NOTES**

TEI<sub>1</sub> BLOCK DATA ASSUM LOI<sub>1</sub>  
 ACCOMPLISHED

TEI<sub>4</sub> ASSUMES LOI<sub>1</sub> ACCOMPLISHED  
 BUT NO LOI<sub>2</sub>

REPORT

P52 - (LDG SITE REFSMMAT)

N71: \_ \_ \_ , \_ \_ \_

N05: \_ \_ \_ . \_ \_ \_

N93:

X \_ \_ . \_ \_ \_

Y \_ \_ . \_ \_ \_

Z \_ \_ . \_ \_ \_

GET \_ \_ \_ : \_ \_ \_ : \_ \_ \_

UPDATE CSM  
 BLOCK DATA

MISSION	EDITION	DATE	TIME	DAY / REV	PAGE
APOLLO 11	FINAL	JULY 1, 1969	73:00 - 74:00	4 / TLC	3-45

MCC-H

# FLIGHT PLAN

NOTES

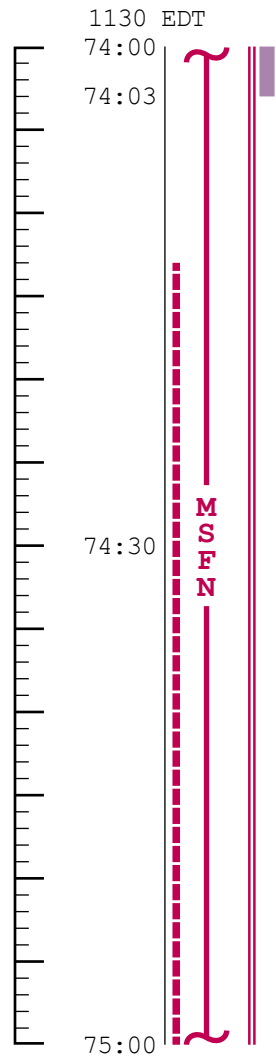

P30 EXTERNAL %V  
 EXT ΔV - P30  
 P00. V49  
 MANEUVER TO BURN ATTITUDE R 357.9, P 225.4, Y 346.2  
 [SEXTANT STAR CHECK]

ROLL TO ACQUIRE MSFN  
 SPS PRETHRUST - P40 (TVC TEST)  
 ROLL TO BURN ATTITUDE

S-BAND SQUELCH - OFF

PITCH UP 360° AT 0.2°/SEC  
 TO OBSERVE LUNAR SURFACE

GO INERTIAL  
 V64 REACQUIRE MSFN

EMS ΔV TEST

MISSION	EDITION	DATE	TIME	DAY / REV	PAGE
APOLLO 11	FINAL	JULY 1, 1969	74:00 - 75:00	4 / TLC	3-46



THIS PAGE INTENTIONALLY LEFT BLANK.

LOI<sub>1</sub>  
BURN CHART

	P OR Y RATES	ATT DEVIATION	SHUTDOWN TIME	RESIDUALS
LOI <sub>1</sub>	10°/SEC TAKEOVER	±10° TAKEOVER	BT +10 SEC	DO NOT TRIM

LOI <sub>1</sub> V <sub>GO</sub>	BT	TRAJECTORY	ABORT MODE
2924.0 - 2129.0	0 - 110	HYPERBOLIC	MODE I - COAST 2 HR - DPS - P37 (P37 BEYOND SPHERE FOR VGO >2279 AND BT <90)
2129.0 - 1589.0	110 - 180	UNSTABLE	MODE II - COAST 2 HR - 2 DPS BURNS FOR STABILIZATION AND WATER OR CLA LANDING
1589.0 - 0	180 - 365	LUNAR ORBIT	MODE III - DPS BURN AFTER ONE REV

MCC-H

# FLIGHT PLAN

NOTES

1230 EDT  
75:00

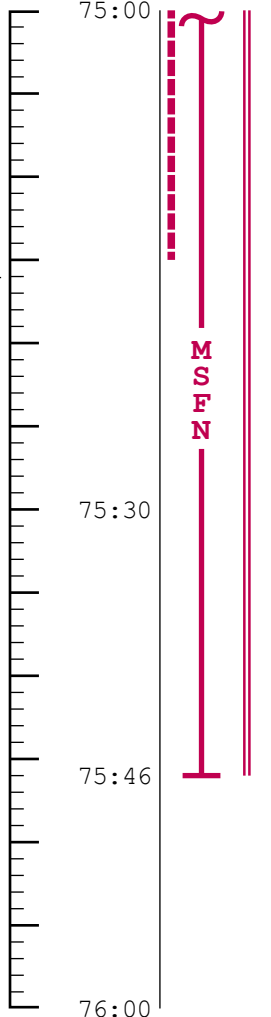

UPLINK CSM  
LOS AND AOS  
(WITH & WITHOUT  
LOI1)

GO/NO GO

CMP - PRE LOI<sub>1</sub> SYSTEMS CKS

- C&W CK
- CM RCS CK
- SM RCS CK
- SPS PERIODIC MON
- EPS PERIODIC MON
- ECS PERIODIC MON

COPY UPDATE: LOS \_\_\_:\_\_\_:\_\_\_

AOS WITH LOI<sub>1</sub> \_\_\_:\_\_\_:\_\_\_

AOS W/O LOI<sub>1</sub> \_\_\_:\_\_\_:\_\_\_

EXT ΔV - P30 (RELOAD N81 WITH PAD VALUES)

SPS THRUST - P40

MNVR TO BURN ATTITUDE

R 357.9, P 225.4, Y 346.2

SEXTANT STAR CHECK

GO/NO GO FOR LOI<sub>1</sub>

PCM-LO

S-BAND AUX-DOWN VOICE BACKUP

GDC ALIGN TO IMU

LOI<sub>1</sub>

GETI: 75:54:28  
NO ULLAGE  
BT: 5 MIN 59.9 SEC  
ΔV<sub>T</sub>: 2924.1 FPS  
ORBIT: 59.2 x 169.8  
RETROGRADE  
DO NOT TRIM

NOTE: INITIATE LOI<sub>1</sub>  
WITH BANK B BALL VALVES

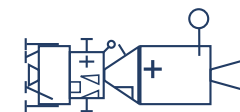
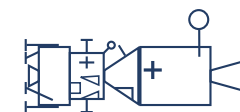

MISSION	EDITION	DATE	TIME	DAY / REV	PAGE
APOLLO 11	FINAL	JULY 1, 1969	75:00 - 76:00	4 / 1	3-47

MCC-H

1330 EDT

# FLIGHT PLAN

NOTES

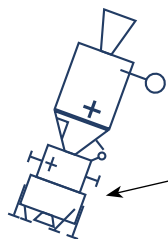

R180, P315/295, Y0  
HGA P-20, Y355  
DUMP DSE

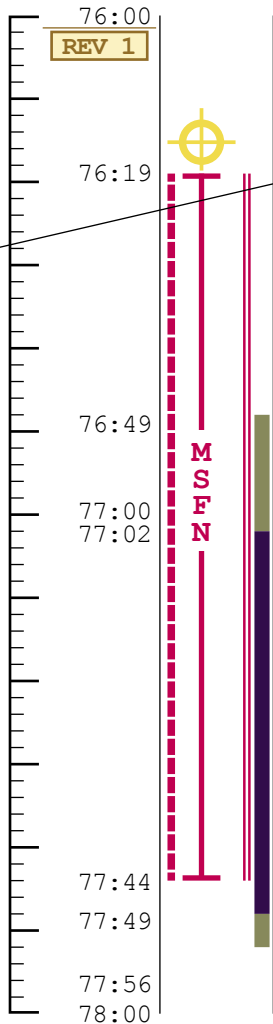

V66 - TRANSFER CSM STATE VECTOR  
TO LM SLOT

SM RCS AND SPS MON CK  
ROLL 180°, PITCH DOWN 70°,  
YAW LEFT 14°  
V64 REACQUIRE MSFN  
ORB RATE

LOI<sub>1</sub> BURN STATUS REPORT

BURN STATUS REPORT				
X	X	<input type="checkbox"/>	•	ΔTIG
X	X	<input type="checkbox"/>	•	BT
<input type="checkbox"/>	<input type="checkbox"/>	<input type="checkbox"/>	•	V <sub>gx</sub>
TRIM				
X	X	X		R
X	X	X		P
X	X	X		Y
<input type="checkbox"/>	<input type="checkbox"/>	<input type="checkbox"/>	•	V <sub>gx</sub>
<input type="checkbox"/>	<input type="checkbox"/>	<input type="checkbox"/>	•	V <sub>gy</sub>
<input type="checkbox"/>	<input type="checkbox"/>	<input type="checkbox"/>	•	V <sub>gz</sub>
<input type="checkbox"/>	<input type="checkbox"/>	<input type="checkbox"/>	•	ΔV <sub>c</sub>
X	X	X		FUEL
X	X	X		OX
X	X	X		UNBAL

MISSION	EDITION	DATE	TIME	DAY / REV	PAGE
APOLLO 11	FINAL	JULY 1, 1969	76:00 - 78:00	4 / 1	3-48

**MCC-H**

1530 EDT

78:00

REV 2

78:27

78:30

78:58

79:00

DUMP DSE

UPLINK CMC

CSM STATE VECTOR  
LOI<sub>2</sub> TARGET LOAD

UPDATE CSM

LOI<sub>2</sub> MNVR PAD  
BLOCK DATA



MSFN

# FLIGHT PLAN

EAT PERIOD

V64 REACQUIRE MSFN  
HGA P -20, Y 359

V66 - TRANSFER CSM STATE VECTOR TO LM SLOT

RECORD LOI<sub>2</sub> MNVR PAD AND BLOCK DATA (TEI<sub>5</sub>)

**NOTES**

TEI<sub>5</sub> BLOCK DATA  
ASSUMES LOI<sub>1</sub> & LOI<sub>2</sub>  
ACCOMPLISHED

MISSION	EDITION	DATE	TIME	DAY / REV	PAGE
APOLLO 11	FINAL	JULY 1, 1969	78:00 - 79:00	4 / 2	3-49

MCC-H

1630 EDT

# FLIGHT PLAN

NOTES

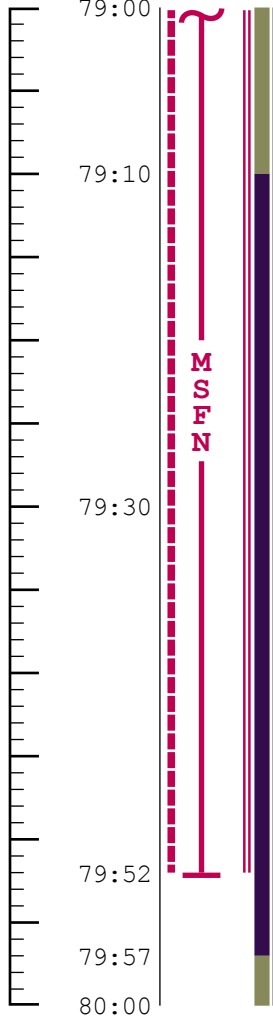

CMP - PRE LOI<sub>2</sub> SYSTEMS MONITOR

GO INERTIAL

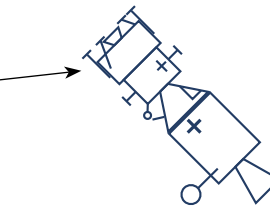
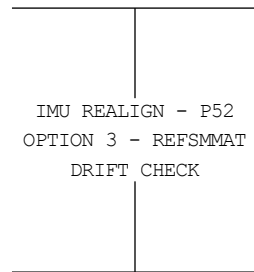

R 180, P 315/182, Y 0  
HGA P -45, Y 180

P30 EXTERNAL ΔV  
MANEUVER TO LOI<sub>2</sub> BURN ATTITUDE

P40 SPS THRUST  
GO INERTIAL

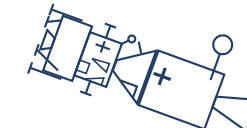
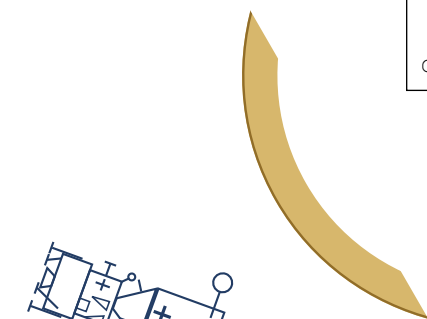

R 0, P 50.1/212.3, Y 359.6

SEXTANT STAR CHECK  
EMS ΔV TEST  
SM RCS CHECK  
LOAD DAP FOR 2 JET ULLAGE  
R1 = 20111  
R2 = 11111

REPORT

P52 - (LDG SITE REFSMMAT)

N71: \_ \_ \_ / \_ \_ \_

N05: \_ \_ \_ . \_ \_ \_

N93:

X \_ \_ . \_ \_ \_

Y \_ \_ . \_ \_ \_

Z \_ \_ . \_ \_ \_

GET \_ \_ \_ : \_ \_ \_ : \_ \_ \_

79:15

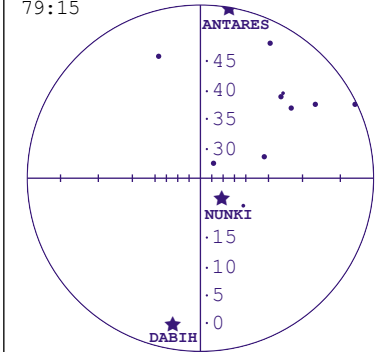

PIPA BIAS CHECK

MISSION	EDITION	DATE	TIME	DAY / REV	PAGE
APOLLO 11	FINAL	JULY 1, 1969	79:00 - 80:00	4 / 2	3-50

THIS PAGE INTENTIONALLY LEFT BLANK.

LOI<sub>2</sub>  
BURN CHART

	P OR Y RATES	ATT DEVIATION	SHUTDOWN TIME	RESIDUALS
LOI <sub>2</sub>	10°/SEC TAKEOVER	±10° TAKEOVER	BT +1 SEC	TRIM X AXIS TO 1 FPS



# FLIGHT PLAN

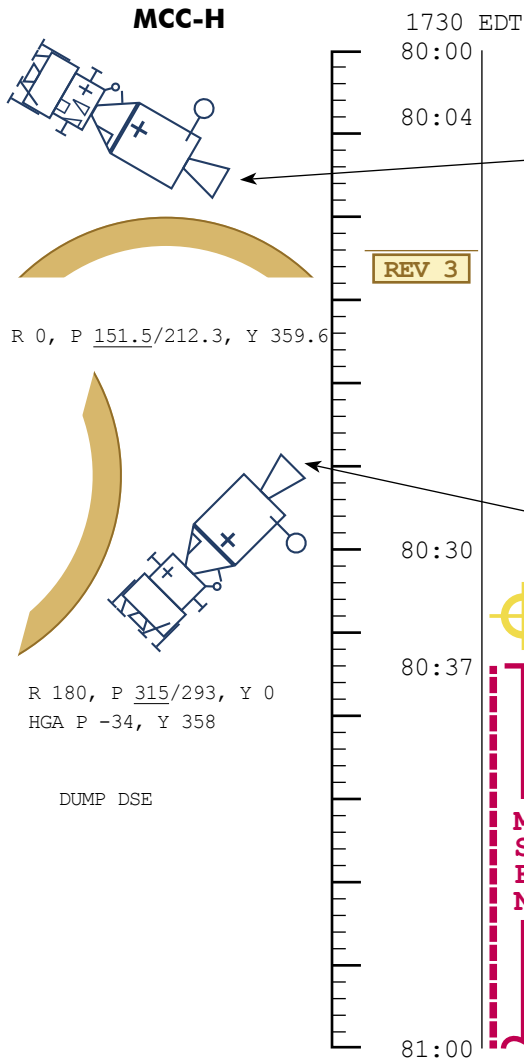

GDC ALIGN TO IMU

GETI: 80:09:30  
 ULLAGE: 2 JET, 19 SEC  
 BT: 16.4 SEC  
 $\Delta V_T$ : 157.8 FPS  
 ORBIT: 53.6 x 65.6  
 RETROGRADE  
 DO NOT TRIM

LOI<sub>2</sub>

SM RCS CHECK  
 SPS MONITOR CHECK  
 V66 - TRANSFER CSM STATE VECTOR TO LM SLOT  
 BATTERY CHARGE, BATTERY A

ROLL 180°, PITCH DOWN 81°, ORB RATE

OBSERVE LUNAR SURFACE

V64 ACQUIRE MSFN

LOI<sub>2</sub> BURN STATUS REPORT

PRESSURIZE THE LM  
 CM/LM PRESSURE EQUALIZATION VALVE - OPEN

## NOTES

BURN STATUS REPORT				
X	X	<input type="checkbox"/>	:	ΔTIG
X	X		:	BT
<input type="checkbox"/>			.	V <sub>gx</sub>
TRIM				
X	X	X		R
X	X	X		P
X	X	X		Y
<input type="checkbox"/>			.	V <sub>gx</sub>
<input type="checkbox"/>			.	V <sub>gy</sub>
<input type="checkbox"/>			.	V <sub>gz</sub>
<input type="checkbox"/>			.	ΔV <sub>C</sub>
X	X	X		FUEL
X	X	X		OX
X	X	X		UNBAL

MISSION	EDITION	DATE	TIME	DAY / REV	PAGE
APOLLO 11	FINAL	JULY 1, 1969	80:00 - 81:00	4 / 3	3-51

**MCC-H**

UPDATE CSM  
 P22 AUTO OPTICS  
 ALT LMK (A-1)  
 TRACKING  
 (SEE GET 82:35)

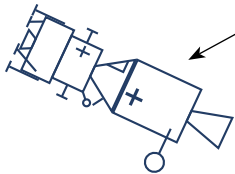

R 180, P 318/196, Y 0  
 HGA P -60, Y 182

1830 EDT

81:00

81:04

81:10

81:30

81:49

81:56

82:00

M  
S  
F  
N

# FLIGHT PLAN

RECORD UPDATE (SEE GET 82:40)

GO INERTIAL

IMU REALIGN - P52  
 OPTION 3 - REFSMMAT

STOW OPTICS

TUNNEL VENT VALVE - LM/CM ΔP  
 VERIFY LM/CM ΔP <0.2

PREPARE FOR LM INGRESS

CMP - CLEAR TUNNEL OF CM HATCH  
 INSPECT TUNNEL & DOCKING LATCHES  
 REMOVE PROBE & DROGUE  
 STOW CM HATCH, PROBE & DROGUE  
 LMP - OPEN LM HATCH  
 VERIFY DOCKING TUNNEL INDEX ANGLE  
 IVT TO LM

LMP - LM ENTRY STATUS CHECKS

**NOTES**

REPORT

P52 - (LDG SITE REFSMMAT)

N71: \_ \_ \_ / \_ \_ \_

N05: \_ \_ \_ . \_ \_ \_

N93: \_ \_ \_ . \_ \_ \_

X \_ \_ . \_ \_ \_

Y \_ \_ . \_ \_ \_

Z \_ \_ . \_ \_ \_

GET \_ \_ \_ : \_ \_ \_ : \_ \_ \_

MISSION	EDITION	DATE	TIME	DAY / REV	PAGE
APOLLO 11	FINAL	JULY 1, 1969	81:00 - 82:00	4 / 3	3-52

THIS PAGE INTENTIONALLY LEFT BLANK.

CSM/LM TYPICAL LANDMARK TRACKING PROFILE

2 DEG PITCH DOWN FROM  
LOCAL HORIZONTAL BEGIN  
0.3 DEG/SEC PITCH DOWN  
AT AOS.

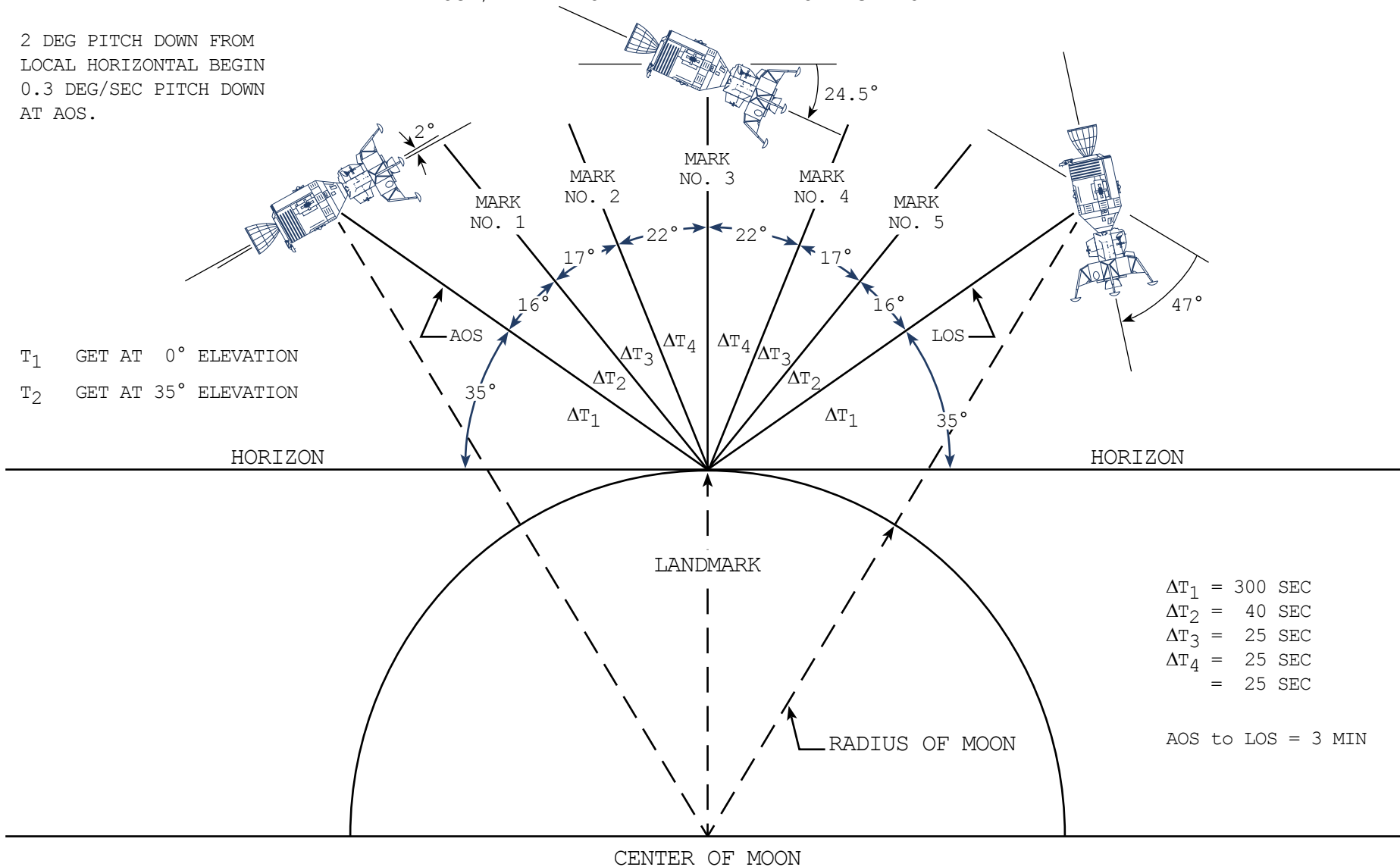

T<sub>1</sub> GET AT 0° ELEVATION  
T<sub>2</sub> GET AT 35° ELEVATION

$\Delta T_1 = 300 \text{ SEC}$   
 $\Delta T_2 = 40 \text{ SEC}$   
 $\Delta T_3 = 25 \text{ SEC}$   
 $\Delta T_4 = 25 \text{ SEC}$   
 = 25 SEC  
 AOS to LOS = 3 MIN

# FLIGHT PLAN

**CSM  
CMP**

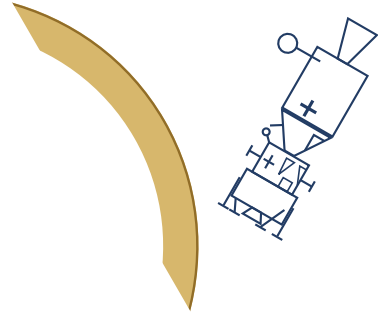

R 0, P 257/297, Y 0

MANEUVER TO LANDMARK  
TRACK ATTITUDE  
GO INERTIAL  
SELECT OMNI B

P22 ORBITAL NAVIGATION  
UNSTOW OPTICS

TRACK LANDMARK ALT LMK (A-1)  
(5 MARKS ON LMK)  
PITCH DOWN 0.3°/SEC  
DO NOT INCORPORATE MARKS

STOW OPTICS



1930 EDT

82:00

82:02

REV 4

82:30

82:35

83:00

**CDR**

**LM**

**LMP**

**MCC-H**

AID LMP AS REQUIRED

PERFORM HOUSEKEEPING CHORES  
1 STOW HELMET STOWAGE BAGS  
2 UNSTOW MIRROR, CHECKLIST AND DISPOSAL ASSEMBLY  
3 STOW INTERIM STOWAGE ASSEMBLY  
4 UNSTOW AND CONFIGURE FOR  
USE: 16mm/HCEX  
(f4, 500, INF) 6 fps

P22 AUTO OPTICS  
LMK ID A-1  
T<sub>1</sub> 8 2 : 4 1 : 0 6 (HOR)  
T<sub>2</sub> 8 2 : 4 6 : 1 7 (35°)  
1 4 NM (N)  
N 89  
LAT 0 2 . 0 0 0  
LONG/2 3 2 . 7 5 0  
ALTITUDE- 0 0 0 . 0 0 0 NM

MISSION	EDITION	DATE	TIME	DAY / REV	PAGE
APOLLO 11	FINAL	JULY 1, 1969	82:00 - 83:00	4 / 4	3-53

# FLIGHT PLAN

## CSM CMP

CSM POWER TO LM - OFF  
(AT LMP REQUEST)  
STOP PITCH RATE, ROLL  
TO SLEEP ATTITUDE  
GO INERTIAL  
V64 ACQUIRE MSFN

RECORD BLOCK DATA  
(TEI 2)  
V66 - TRANSFER STATE VECTOR  
TO LM SLOT  
CSM POWER TO LM - ON  
(AT LMP REQUEST)

INSTALL CM HATCH  
TUNNEL VENT VALVE - LM PRESS

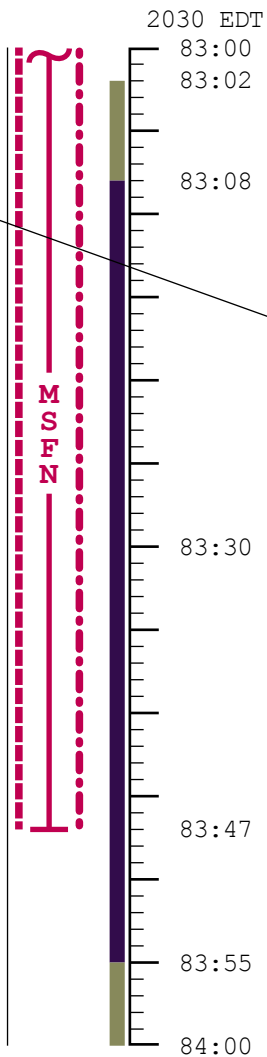

## CDR

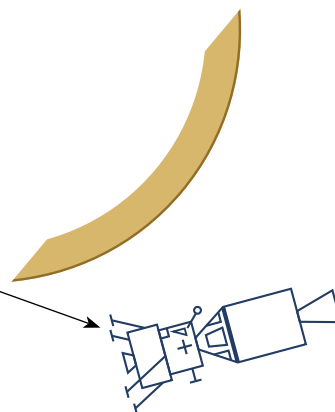

R 82, P 350/229, Y 0  
HGA P 8, Y 270

## LM

### LMP

TRANSFER TO LM POWER  
COMM ACTIVATION

S-BAND/VHF B  
VOICE & TM TEST

REPORT OPS SOURCE  
PRESSURE

COMM DEACTIVATION

TRANSFER TO CSM POWER

LMP IVT TO CSM  
CLOSE LM HATCH

## MCC-H

DUMP DSE

RECORD OPS  
SOURCE PRESSURE

UPDATE CSM  
BLOCK DATA

UPLINK CMC  
CSM STATE VECTOR

MISSION	EDITION	DATE	TIME	DAY / REV	PAGE
APOLLO 11	FINAL	JULY 1, 1969	83:00 - 84:00	4 / 4	3-54

MCC-H

2130 EDT

84:00  
84:01

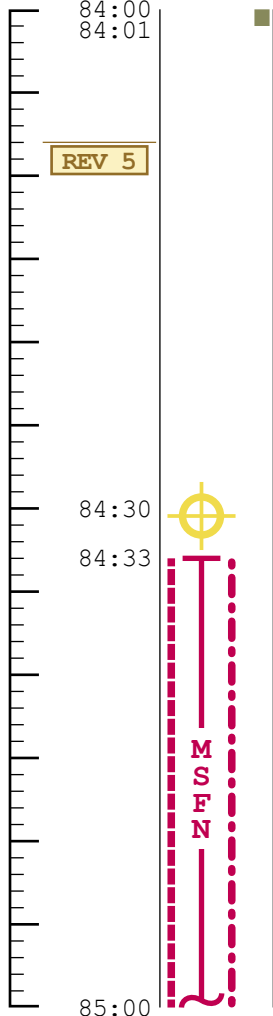

# FLIGHT PLAN

O<sub>2</sub> FUEL CELL PURGE

EAT PERIOD

CO<sub>2</sub> FILTER CHANGE NO. 7  
(9 INTO A, STORE 7 IN B6)

## NOTES

CSM PRESLEEP CHECKLIST  
 CREW STATUS REPORT (RADIATION, MEDICATION)  
 CYCLE O<sub>2</sub> & H<sub>2</sub> FANS  
 CHLORINATE POTABLE WATER  
 SELECT NORMAL LUNAR COMM CONFIGURATION  
 EXCEPT:  
   S-BD SQUELCH - ENABLE  
   HGA TRACK - REACQ  
   HGA BEAM - NARROW  
 VERIFY:  
   WASTE MNGT OVBD DRAIN - OFF  
   WASTE STOW VENT VLV - CLOSED  
   EMERGENCY CABIN PRESS VLV - BOTH  
   SURGE TANK O<sub>2</sub> VLV - ON  
   REPRESS PACK O<sub>2</sub> VALVE - OFF  
   LM TUNNEL VENT VLV - LM PRESS  
   POT H<sub>2</sub>O HTR - OFF

MISSION	EDITION	DATE	TIME	DAY / REV	PAGE
APOLLO 11	FINAL	JULY 1, 1969	84:00 - 85:00	4 / 5	3-55

# LUNAR ORBIT REST PERIOD ATTITUDE

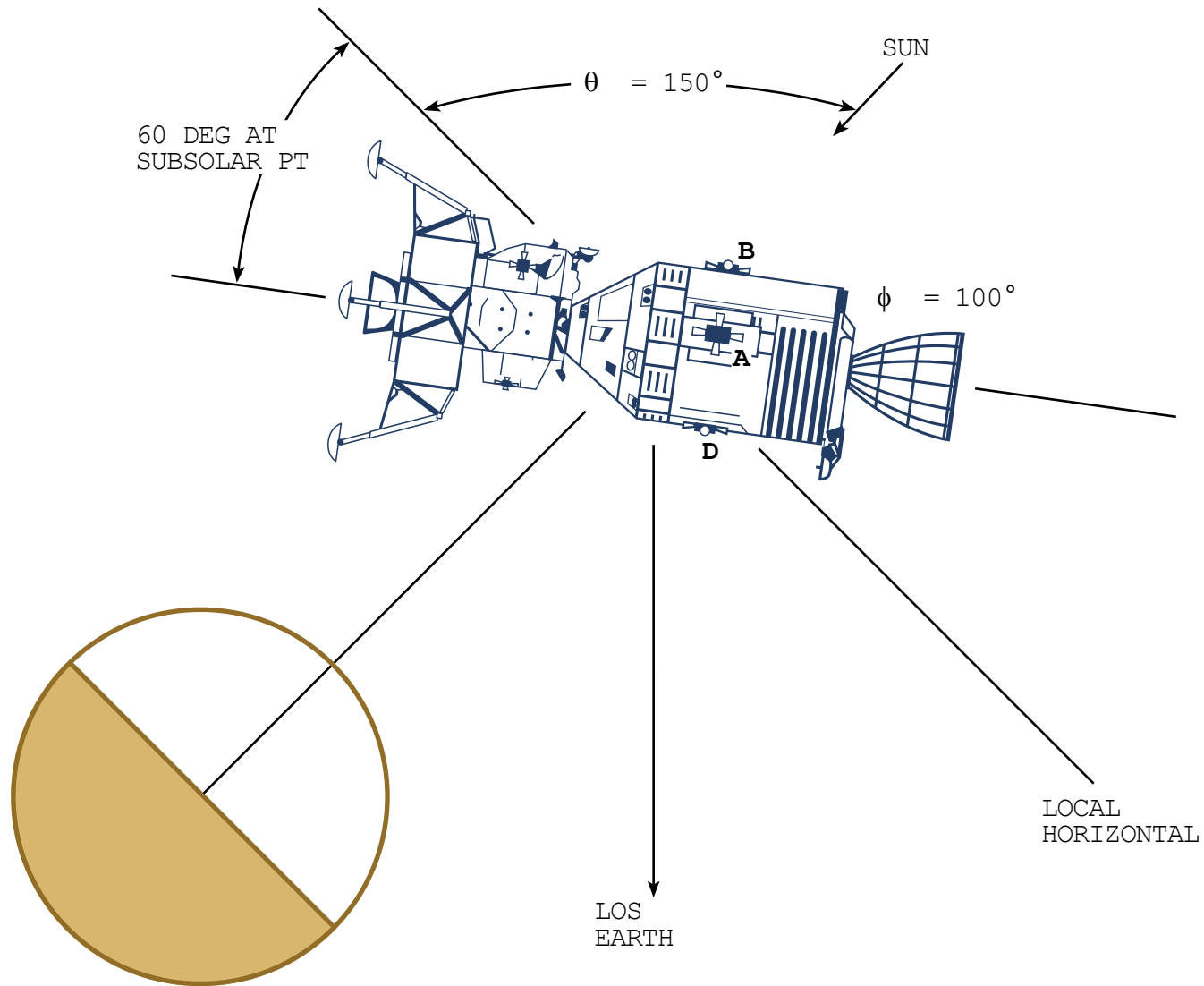



**MCC-H**

DUMP DSE

# FLIGHT PLAN

**NOTES**

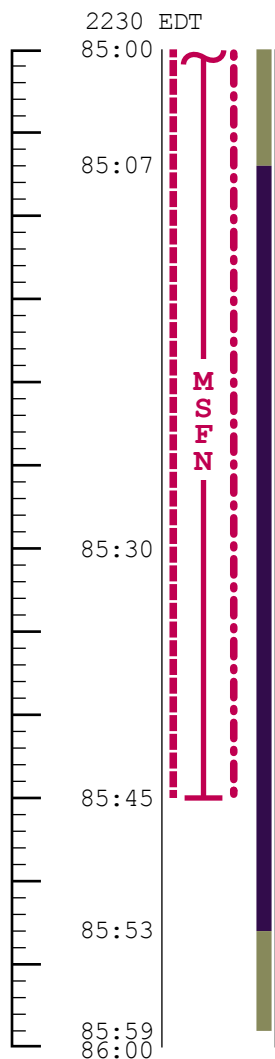

MISSION	EDITION	DATE	TIME	DAY / REV	PAGE
APOLLO 11	FINAL	JULY 1, 1969	85:00 - 86:00	4 / 5	3-56

MCC-H

# FLIGHT PLAN

NOTES

2330 EDT

86:00

REV 6

DUMP DSE

86:30

86:32

86:59

87:00

87:05

87:30

87:43

87:52

87:58

88:00



M  
S  
F  
N

REST PERIOD  
(9 HOURS)

MISSION	EDITION	DATE	TIME	DAY / REV	PAGE
APOLLO 11	FINAL	JULY 1, 1969	86:00 - 88:00	4 / 6	3-57

MCC-H

# FLIGHT PLAN

NOTES

0130 EDT

88:00

REV 7

DUMP DSE

88:30



88:57

89:00

89:04

M  
S  
F  
N

REST PERIOD  
(9 HOURS)

89:30

89:42

89:50

89:55

90:00

MISSION	EDITION	DATE	TIME	DAY / REV	PAGE
APOLLO 11	FINAL	JULY 1, 1969	88:00 - 90:00	4 / 7	3-58

MCC-H

# FLIGHT PLAN

NOTES

0330 EDT

90:00

REV 8

DUMP DSE

90:28

90:30

90:56

91:00

91:02

91:30

91:40

91:49

91:55

92:00



M  
S  
F  
N

REST PERIOD  
(9 HOURS)

MISSION	EDITION	DATE	TIME	DAY / REV	PAGE
APOLLO 11	FINAL	JULY 1, 1969	90:00 - 92:00	4 / 8	3-59

MCC-H

# FLIGHT PLAN

NOTES

0530 EDT

92:00

REV 9

DUMP DSE

92:26

92:30

92:55

93:00

93:01

93:30

93:37

93:47

93:54

94:00



M  
S  
F  
N

REST PERIOD  
(9 HOURS)

REV 10

MISSION	EDITION	DATE	TIME	DAY / REV	PAGE
APOLLO 11	FINAL	JULY 1, 1969	92:00 - 94:00	4 / 9-10	3-60

MCC-H

# FLIGHT PLAN

NOTES

0730 EDT

94:00

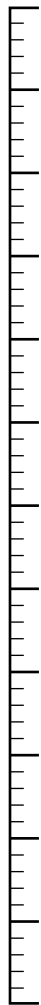

DUMP DSE

94:24

94:30

94:53

94:59  
95:00



EAT PERIOD

MISSION	EDITION	DATE	TIME	DAY / REV	PAGE
APOLLO 11	FINAL	JULY 1, 1969	94:00 - 95:00	5 / 10	3-61

**MCC-H**

UPDATE  
BLOCK DATA  
UPDATE  
BASELINE ALTITUDE  
FOR DESCENT ALTITUDE  
SIGHTINGS

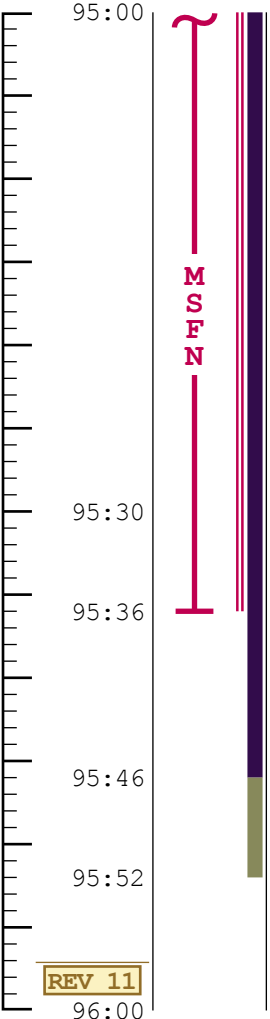

# FLIGHT PLAN

SDR & LMP DON LCG'S  
CMP - RECORD BLOCK DATA - TEI<sub>30</sub>

LMP - COPY BASELINE ALTITUDE

POST SLEEP CHECKLIST  
CREW STATUS REPORT (SLEEP)  
CYCLE O<sub>2</sub> & H<sub>2</sub> FANS  
GDC ALIGN TO IMU  
CONSUMABLES UPDATE  
SELECT NORMAL LUNAR CONFIGURATION

CO<sub>2</sub> FILTER CHANGE NO. 8  
(10 INTO B, STORE 8 IN B6)

CMP: DON PGA W/O HELMET AND GLOVES  
H<sub>2</sub> - PURGE LINE HTRS - ON  
LM TUNNEL VENT VALVE - LM/CM ΔP  
VERIFY LM/CM ΔP <0.2  
OPEN AND STOW CM HATCH  
LMP: VERIFY DOCKING TUNNEL INDEX ANGLE  
IVT TO LM

**NOTES**

CONSUMABLE UPDATE  
(Δ FROM NOMINAL)  
GET: \_\_\_\_\_  
RCS TOT \_\_\_\_\_  
A \_\_\_\_\_  
B \_\_\_\_\_  
C \_\_\_\_\_  
D \_\_\_\_\_  
H<sub>2</sub> TOT \_\_\_\_\_  
O<sub>2</sub> TOT \_\_\_\_\_

MISSION	EDITION	DATE	TIME	DAY / REV	PAGE
APOLLO 11	FINAL	JULY 1, 1969	95:00 - 96:00	5 / 10-11	3-62

**CSM  
CMP**

UNDOCKING PHOTO  
16mm/18/CEX-BRKT-MIR  
(f8, 250, 7) 6 fps  
O<sub>2</sub> & H<sub>2</sub> FUEL CELL PURGE

V64 ACQUIRE MSFN  
CREW STATUS REPORT  
REPORT DOCKING TUNNEL INDEX  
ANGLE TO MSFN  
DEACTIVATE B3 & C4 JETS  
CONFIGURE DAP 21112  
WIDE DB 11001  
(FOR LM STEERABLE  
ANTENNA ACTIVATION)

RECORD LMK 130 PAD DATA  
(SEE GET 98:35)  
AND CSM DAP DATA  
AND LOAD

UNSTOW OPTICS  
P52 - IMU REALIGN  
OPTION 1 PREFERRED

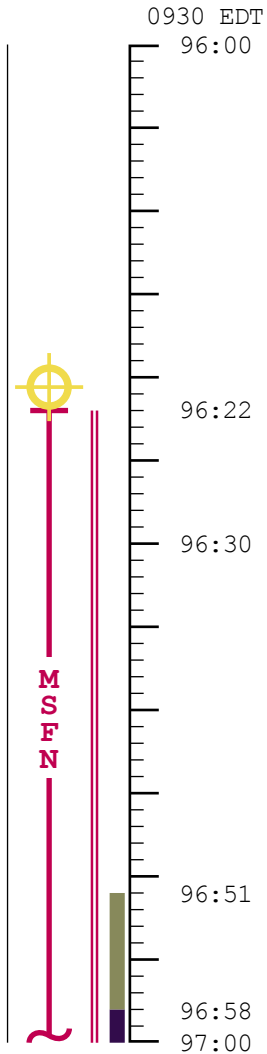

# FLIGHT PLAN

**CDR**

**LM**

**LMP**

**MCC-H**

DON PGA W/O HELMET AND GLOVES	LM FAMILIARIZATION
CSM POWER TO LM - OFF (AT LMP REQUEST)	LM POWER - ON
DISCONNECT AND STOW LM POWER UMBILICAL	EPS ACTIVATION MISSION TIMER ACTIVATION PRIMARY GLYCOL LOOP ACT
IVT TO LM TRANSFER HELMET & GLOVES	CAUTION/WARNING CHECKOUT CB ACTIVATION TB VERIFICATION
ECS ACTIVATION AND C/O CONNECT TO LM ECS	PGNCS TURN - ON AND SELF TEST
	BIO MED SWITCH - LEFT

DUMP DSE

UPLINK CMC

CSM STATE VECTOR  
DESIRED ORIENT  
(LS REFSMMAT)

UPDATE CSM

LMK 130 PAD  
BLOCK DATA  
CSM DAP DATA

MISSION	EDITION	DATE	TIME	DAY / REV	PAGE
APOLLO 11	FINAL	JULY 1, 1969	96:00 - 97:00	5 / 11	3-63



**CSM  
CMP**

REPORT

P52 - (LDG SITE REFSMMAT)  
 N71: \_ \_ \_ , \_ \_ \_  
 N05: \_ \_ \_ . \_ \_ \_  
 N93:  
 X \_ \_ . \_ \_ \_  
 Y \_ \_ . \_ \_ \_  
 Z \_ \_ . \_ \_ \_  
 GET \_ \_ \_ : \_ \_ \_ : \_ \_ \_

VHF CHECKOUT  
 CSM TIME MARK TO LM  
 STOW OPTICS

V06N20E  
 (ON MARK FROM CDR)

RECORD LM PCM DATA

DON HELMET AND GLOVES  
 PGA PRESSURE INTEGRITY CHECK  
 INSTALL DROGUE & PROBE,  
 PRELOAD PROBE  
 INHIBIT ROLL COMMANDS UNTIL  
 LM/CM ΔP >3.5 PSIA  
 COCK LATCHES (12)  
 INSTALL HATCH  
 VENT TUNNEL  
 HATCH INTEGRITY CHECK  
 INSTALL AND ALIGN DOCKING  
 TARGET

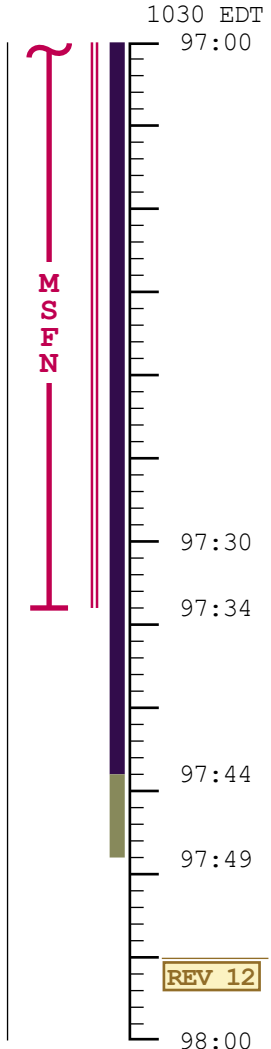

**FLIGHT PLAN**

**CDR**

**LM**

**LMP**

SUIT FAN/H <sub>2</sub> O SEP CHECK	SEC S-BAND T/R AND POWER AMPLIFIER CHECK
GLYCOL PUMP CHECK	S-BAND STEERABLE ANTENNA ACTIVATION P 152, Y -9
VHF-B ACTIVATION	IVT TO CSM
E MEMORY DUMP VHF CHECKOUT (COMM CHECK WITH CSM)	DON PGA
LGC/CMC CLOCK SYNC T EPHEM UPDATE	IVT TO LM TRANSFER HELMET & GLOVES
DOCKED IMU COARSE ALIGN REPORT GIMBAL ANGLES AND TIME TO MSFN	CONNECT TO LM ECS AND COMM
AFT OMNI - LBR SLEW STEERABLE ANTENNA P 187, Y 70	ASCENT BATTERY ACTIVATION AND CHECKOUT RECORD ED BAT VOLTS

**MCC-H**

UPDATE LM  
 STEERABLE ANTENNA  
 ANGLES  
 (GET: 97:10)

UPDATE LM  
 STEERABLE ANTENNA  
 ANGLES P 187, Y 70  
 (GET: 98:55)

COPY GIMBAL ANGLES  
 AND TIME

MISSION	EDITION	DATE	TIME	DAY / REV	PAGE
APOLLO 11	FINAL	JULY 1, 1969	97:00 - 98:00	5 / 11-12	3-64

CSM/LM TYPICAL LANDMARK TRACKING PROFILE

2 DEG PITCH DOWN FROM  
 LOCAL HORIZONTAL BEGIN  
 0.3 DEG/SEC PITCH DOWN  
 AT AOS.

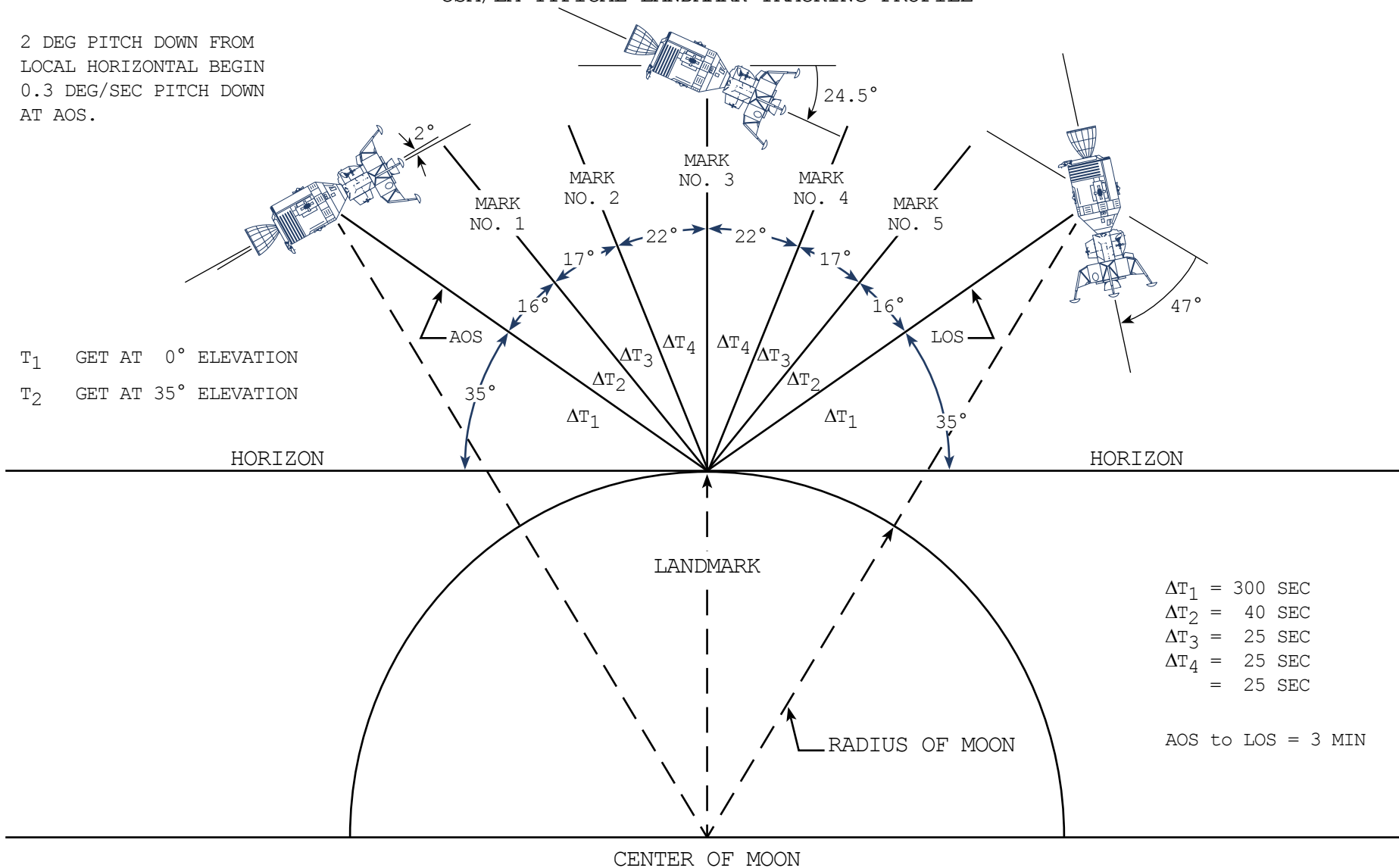

T<sub>1</sub> GET AT 0° ELEVATION  
 T<sub>2</sub> GET AT 35° ELEVATION

ΔT<sub>1</sub> = 300 SEC  
 ΔT<sub>2</sub> = 40 SEC  
 ΔT<sub>3</sub> = 25 SEC  
 ΔT<sub>4</sub> = 25 SEC  
 = 25 SEC  
 AOS to LOS = 3 MIN

**CSM  
CMP**

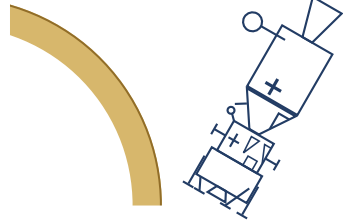

MANEUVER TO TRACKING ATTITUDE  
R 0, P 278/290, Y 0  
DOFF HELMET & GLOVES

SELECT OMNI C

GO INERTIAL  
UNSTOW OPTICS  
P22 ORBITAL NAVIGATION

TRACK LDG SITE LANDMARK  
(5 MARKS ON LDMK 130)  
PITCH DOWN 0.3°/SEC AT T<sub>2</sub>  
DO NOT INCORPORATE MARKS

PITCH DOWN, 0.5°/SEC

STOP PITCH AND GO INERTIAL

V64 ACQUIRE MSFN

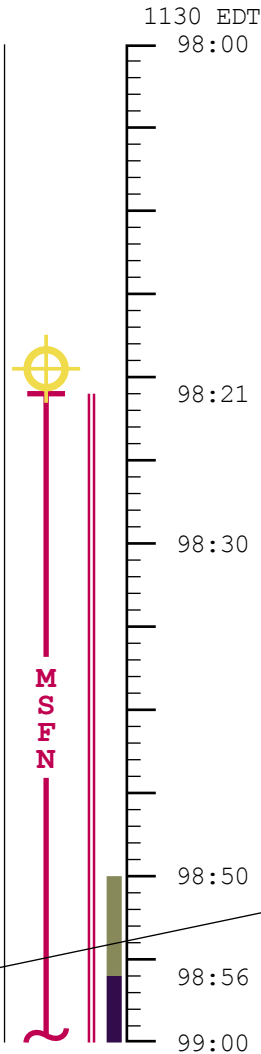

# FLIGHT PLAN

**CDR**

**LM**

**LMP**

**MCC-H**

DON HELMET & GLOVES	DON HELMET & GLOVES
ARS/PGA PRESSURE INTEGRITY CHECK	ARS/PGA PRESSURE INTEGRITY CHECK
CABIN REGULATOR CHECK	CABIN REGULATOR CHECK
DOFF HELMET & GLOVES	DOFF HELMET & GLOVES
COPY DAP DATA COPY GYRO TORQUE ANGLES AND FINE ALIGN IMU X __, Y __, Z __	SELECT OMNI <u>FWD</u> BIO MED SWITCH - RIGHT
RATE GYRO CHECK	AGS ACT & SELF TEST
 R 0, P 135/14, Y 0 HGA P -45, Y 3	V64 ACQUIRE MSFN ANT P 187, Y 70

UPDATE LM

DAP DATA  
GYRO TORQUE ANGLES

P22 AUTO OPTICS  
LMK ID 130  
T<sub>1</sub> - 9 8 : 4 0 : 0 2 (HOR)  
T<sub>2</sub> - 9 8 : 4 5 : 0 8 (35°)  
9 6 NM (N) OR S)  
N 89  
LAT + 0 1 . 2 4 3  
LONG/2 + 1 1 . 8 4 4  
ALTITUDE- 0 0 1 . 4 6 NM

DUMP DSE

MISSION	EDITION	DATE	TIME	DAY / REV	PAGE
APOLLO 11	FINAL	JULY 1, 1969	98:00 - 99:00	5 / 12	3-65

**CSM  
CMP**

STOW FLIGHT PLAN  
UNSTOW SOLO BOOK  
COPY PADS

DON HELMET & GLOVES  
SC CONT - SCS  
MIN/MAX DB, LOW/HIGH RATE  
(AT REQUEST OF CDR)  
GO/NO-GO FOR UNDOCKING  
DISABLE ROLL JETS FOR  
RCS HOT FIRE  
VERIFY TUNNEL VENT VALVE - OFF  
RECORD LM PCM DATA

MANEUVER TO  
AGS CALIBRATION ATTITUDE

RATES <0.1°/SEC  
DISABLE THRUSTERS FOR 32 SEC  
(AT REQUEST OF LMP)  
MANEUVER TO UNDOCKING ATTITUDE  
R 0, P 320/14, Y 0

# FLIGHT PLAN

1230 EDT

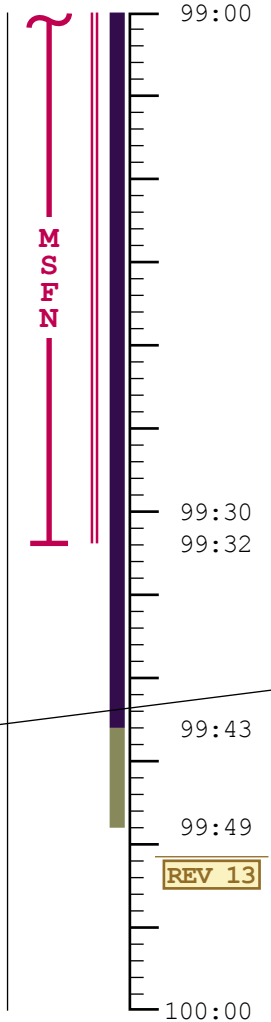

**CDR**

DRIFT CHECK - REPORT GIMBAL  
ANGLES & TIME TO MSFN  
DEPLOY LANDING GEAR

ORDEAL INITIALIZATION

LOAD DAP DATA - 32012

CSM WT \_\_\_\_\_

P TRIM \_\_\_\_\_

Y TRIM \_\_\_\_\_

DPS GIMBAL DRIVE AND  
THROTTLE TEST

RCS PRESSURIZATION

RCS CHECKOUT

RR ACT & SELF TEST

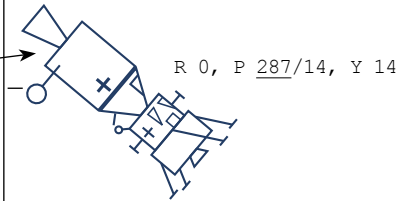

DPS PRESS & CHECKOUT

**LM**

**LMP**

V47 INITIALIZE AGS

COPY AGS ABORT CONSTANT  
AND K FACTOR

RCS PRESSURIZATION

GO/NO-GO FOR UNDOCKING  
RCS CHECKOUT

AFT OMNI - LBR

SLEW STEERABLE ANTENNA  
ANT P 123, Y -37

AGS ACCEL & GYRO CALIBRATION

**MCC-H**

UPLINK LGC

LS REFSMMAT  
LM & CSM STATE VECTORS  
LGC/CMC CLOCK SYNC  
PIPA BIAS  
LGC ABORT CONSTANT

UPDATE LM

AGS ABORT CONSTANT  
AGS K FACTOR

UPLINK CMC

LM & CSM STATE VECTORS

UPDATE CSM

P30 MNVR PAD  
(SEPARTATION)

GO/NO-GO

UPDATE LM

STEERABLE ANTENNA  
ANGLES (GET: 100:25)

MISSION	EDITION	DATE	TIME	DAY / REV	PAGE
APOLLO 11	FINAL	JULY 1, 1969	99:00 - 100:00	5 / 12-13	3-66

**CSM  
CMP**

RR TRANSPONDER ACT & SELF TEST  
 CONFIGURE DAP  
 FOR UNDOCKING, CSM ONLY  
 R1 = 11102  
 R2 = 11111  
 SC CONT - SCS  
 START 16mm CAMERA

UNDOCK

ENABLE B3 & C4 RCS JETS  
 V64 ACQUIRE MSFN  
 LM INSPECTION, CAMERA OFF

COPY PADS  
 SC CONT - CMC  
 P30 EXT ΔV  
 P41 RCS THRUST

CSM SEPARATION  
 GET: 100:39:50  
 BT: 8.0 SEC  
 ΔV<sub>T</sub>: 2.5 FPS  
 -X THRUSTERS  
 ORBIT: 55.6 x 63.1

P20 AUTO MANEUVER  
 SXT & VHF RANGING

COPY PAD

**FLIGHT PLAN**

1330 EDT

100:00

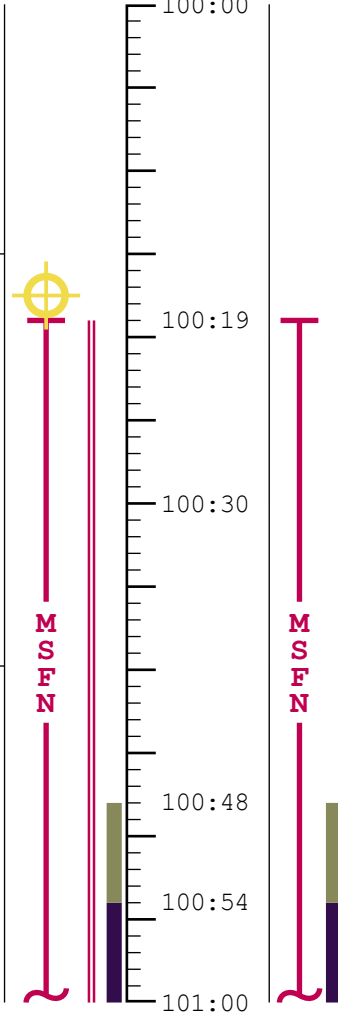

**CDR**

DAP DATA LOAD

YAW LEFT 60°, PITCH UP 110°  
 SET ORDEAL  
 YAW 360°, LM INSPECTION

CSM: R 0, P 90/14, Y 0  
 HGA P -46, Y 3

LR ACT AND SELF TEST

P30 EXT ΔV  
 RR MAN LOCK - ON

VHF RANGING  
 RR - OFF

**LM**

DON HELMETS AND GLOVES  
 PREPARE FOR UNDOCKING

UNDOCK

ACQUIRE MSFN  
 ANT P 123, Y -37  
 P27 UPDATE

BIO MED SWITCH - LEFT

COPY PADS

SEPARATION

LM FDAI: R 0, P 304, Y 0

P27 UPDATE  
 V47 AGS UPDATE  
 AGS ALIGN

COPY PAD

**LMP**

V47 AGS ALIGN  
 CSM: R 0, P 15/14, Y 0

**MCC-H**

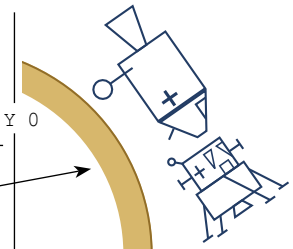

LM FDAI: R 0, P 194, Y 60

UPLINK LGC

LM STATE VECTOR  
 (DOI -10)  
 DOI TARGET LOAD  
 DESCENT TARGET LOAD  
 PIPA BIAS

UPDATE LM

DOI MNVR PAD  
 PDI PAD  
 PDI ABORT <10 MIN  
 NO PDI +12 PAD  
 PDI ABORT >10 MIN

UPLINK LGC

CSM STATE VECTOR  
 (PDI +25)

UPDATE LM

LUNAR SURFACE PAD

UPDATE CSM

CSM RESCUE PAD

MISSION	EDITION	DATE	TIME	DAY / REV	PAGE
APOLLO 11	FINAL	JULY 1, 1969	100:00 - 101:00	5 / 13	3-67

**CSM  
CMP**

P27 UPDATE  
P52 IMU REALIGN  
OPTION 3 REFSMMAT

REPORT

P52 - (LDG SITE REFSMMAT)  
N71: \_ \_ / \_ \_ \_  
N05: \_ \_ \_ . \_ \_ \_  
N93:  
X \_ \_ . \_ \_ \_ \_  
Y \_ \_ . \_ \_ \_ \_  
Z \_ \_ . \_ \_ \_ \_  
GET \_ \_ \_ : \_ \_ : \_ \_

GDC ALIGN TO IMU  
VHF B - DATA  
P20 AUTO MANEUVER TO SEXTANT  
TRACK LM  
  
CONFIRM DOI - VHF RANGING  
INCORPORATE P76  
P20 AUTO MANEUVER TO SEXTANT  
TRACK LM  
SEXTANT TRACK ONLY  
DOFF HELMET & GLOVES

# FLIGHT PLAN

1430 EDT

101:00



101:30

101:41

101:47

REV 14

102:00



REPORT

P52 - (LDG SITE REFSMMAT)  
N71: \_ \_ / \_ \_ \_  
N05: \_ \_ \_ . \_ \_ \_  
N93:  
X \_ \_ . \_ \_ \_ \_  
Y \_ \_ . \_ \_ \_ \_  
Z \_ \_ . \_ \_ \_ \_  
GET \_ \_ \_ : \_ \_ : \_ \_

P40 DPS THRUST  
MNVN TO DOI ATTITUDE

TRIM V<sub>x</sub> RESIDUALS  
PITCH DOWN, P=195, RR - ON  
P20 MAN LOCK - ON

RR - OFF

P30 EXT ΔV  
LOAD PDI +12 ABORT  
PITCH DOWN TO 125°  
YAW LEFT 180°

**LM**

**LMP**

SYSTEMS CHECKS

V47 AGS ALIGN

OMNI AFT, PCM LBR  
VHF A-VOICE, B-DATA

SLEW STEERABLE ANTENNA  
ANT P 220, Y 28

N20 AGS ALIGN  
LOADS AGS EXT ΔV

GETI: 101:38:48  
ULLAGE: 2 JET, 7.5 SEC  
BT: 28.5 SEC  
ΔV: 70 FPS  
RETROGRADE  
ORBIT 8.97 x 57.87

VHF A-VOICE/RNG  
VHF B - XMTR - OFF  
SET CAMERA  
16mm/HCEX (4,5000, INF) 6 fps  
COAS OVERHEAD

**MCC-H**

UPLINK CMC

CSM STATE VECTOR  
(PDI +25)  
LM STATE VECTOR  
(DOI -10)  
PIPA BIAS  
DUMP DSE

GO/NO-GO FOR DOI

UPDATE LM

STEERABLE ANTENNA  
ANGLES (GET: 102:19)

CSM: R 0, P 215/319, Y 0

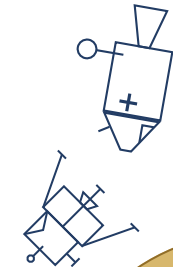

LM FDAI: R 0, P 294.9, Y 0

MISSION	EDITION	DATE	TIME	DAY / REV	PAGE
APOLLO 11	FINAL	JULY 1, 1969	101:00 - 102:00	5 / 13-14	3-68

# FLIGHT PLAN

**CSM**  
**CMP**

**MCC-H**

SEXTANT AND VHF  
TRACKING OF LM

TERMINATE P20 TRACK

P20 AUTO MANEUVER  
TO SEXTANT TRACK LM

P00, MANUAL ATTITUDE  
PITCH RATE DOWN 0.2°/SEC

STOP PITCH AT  
R 0, P 282/179, Y 0  
GO INERTIAL  
CONFIRM STAY/NO-STAY  
V44 SET LS FLAG  
CONFIRM STAY/NO-STAY

RR TRANSPONDER - OFF

1530 EDT

102:00

102:17

102:19

102:30

102:46

102:53

103:00

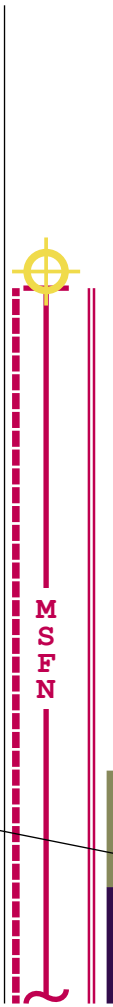

**CDR**

**LM**

**LMP**

P52 PITCH ALIGNMENT CHECK

PITCH TO 285°

RR - ON  
P20 MODE II LOCK - ON

P63

LPD ALTITUDE, ATTITUDE  
POSITION CHECK  
GO/NO-GO FOR PDI

LR - ON

LPD ALTITUDE, ATTITUDE  
POSITION CHECK,  
ULLAGE 7.5 SEC

LPD ALT CK  
YAW RIGHT 174° THEN 6°

EVALUATE MANUAL CONTROL  
PITCH OVER AT P64  
MANUAL ATTITUDE CONTROL

INITIATE DPS VENTING  
V76 RCS MIN IMPULSE

V06N20, ENTER ON MARK  
RECORD PITCH CDU  
N22, RECORD PITCH CDU

BATTERIES 5 & 6 ON

SYSTEMS CHECK  
DPS, OPS, RCS, EPS, CWEA

ANT P 220, Y 28  
ACQUIRE MSFN  
DOI POST BURN REPORT

CSM: R 0, P 348/337, Y 0

N20 AGS ALIGN  
CONFIGURE AGS

START 16mm CAMERA

GETI: 102:35:13  
ULLAGE: 2 JET, 7.5 SEC  
BT = 11 MIN 58 SEC  
 $\Delta V_T = 6766$  FPS

SYSTEMS MONITOR

TOUCHDOWN 102:47:11

PERFORM LUNAR CONTACT CHECKLIST  
STAY/NO-STAY  
STAY/NO-STAY

STOP 16mm CAMERA  
ASCENT BATTERIES OFF  
REPORT 047, 053

COPY BURN REPORT  
GO/NO-GO

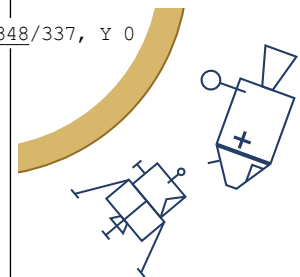

LM FDAI: R 180, P 286.5, Y 0

STAY/NO-STAY

STAY/NO-STAY

ENABLE S-BAND RELAY

MISSION	EDITION	DATE	TIME	DAY / REV	PAGE
APOLLO 11	FINAL	JULY 1, 1969	102:00 - 103:00	5 / 14	3-69

**CSM  
CMP**

REPORT

P52 - (LDG SITE REFSMMAT)  
OPTION 3  
N71: \_ \_ / \_ \_  
N05: \_ \_ . \_ \_  
N93:  
X \_ \_ . \_ \_  
Y \_ \_ . \_ \_  
Z \_ \_ . \_ \_  
GET \_ \_ : \_ \_ : \_ \_

ALIGN GDC, VERIFY ORDEAL

COPY LM TRACKING PAD  
(SEE GET - 104:35)

P22 AUTO MNVR TO  
TRACKING ATTITUDE  
ORB RATE

R 0, P 338/76, Y 0

# FLIGHT PLAN

1630 EDT

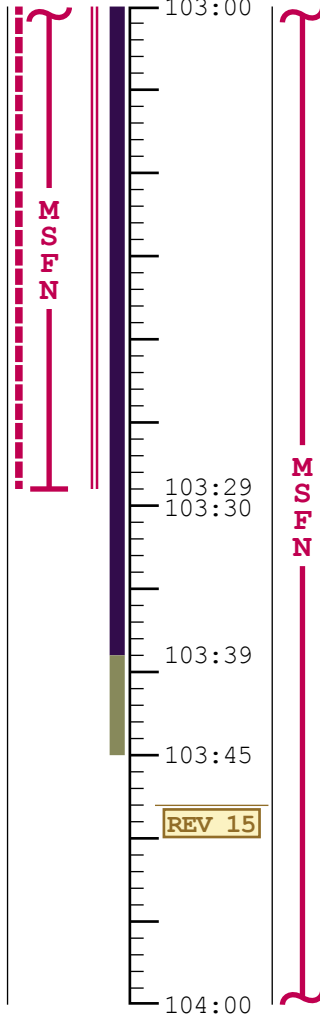

**CDR**

RR TO STANDBY  
REPORT ESTIMATE OF  
LANDED LOCATION  
CLOSE SHADES, DOFF HELMET  
AND GLOVES

BEGIN SIMULATED COUNTDOWN

80mm/BW/CHECKLIST  
60mm/HCEX/CHECKLIST

6 FRAMES FAR FIELD (FOCUS 50`)  
6 FRAMES NEAR FIELD (FOCUS 20`)  
WITH EACH CAMERA  
REMOVE MAGS AND STOW  
INSTALL PROTECTIVE COVER AND  
STOW CAMERAS

PHOTOGRAPH LUNAR SURFACE  
DON HELMET AND GLOVES

**LM**

**LMP**

AGS LUNAR SURFACE GYRO  
CALIBRATION  
LOAD AGS ASCENT TARGET  
H=60,000 FT, H DOT=32 FPS  
CLOSE SHADES, DOFF  
HELMET AND GLOVES

P57 - IMU ALIGN (REFSMMAT)  
GRAVITY MEASUREMENT  
N04: \_ \_ \_ \_

AGS LUNAR ALIGNMENT

P57 - IMU ALIGN (REFSMMAT)  
2 CELESTIAL BODIES

N04: \_ \_ \_ . \_ \_

N05: \_ \_ \_ . \_ \_

N71: \_ \_ / \_ \_

N93:

X \_ \_ . \_ \_

Y \_ \_ . \_ \_

Z \_ \_ . \_ \_

N89:

LAT \_ \_ . \_ \_

LONG/2 \_ \_ . \_ \_

ALT \_ \_ . \_ \_

GET \_ \_ : \_ \_ : \_ \_

INITIALIZE AGS  
COPY AND LOAD ASCENT PAD DATA  
DON HELMET AND GLOVES

VERIFY AGS ASCENT PROGRAM

**MCC-H**

COPY AGS AZIMUTH

COPY LANDED LOCATION,  
GRAVITY MEASURE

UPDATE CSM

LM TRACKING PAD

COPY P57 DATA

COPY AGS AZIMUTH

UPLINK LGC

RLS  
CSM STATE VECTOR  
(TD +1:40)

UPDATE LM

ASCENT PAD

MISSION	EDITION	DATE	TIME	DAY / REV	PAGE
APOLLO 11	FINAL	JULY 1, 1969	103:00 - 104:00	5 / 14-15	3-70



THIS PAGE INTENTIONALLY LEFT BLANK.

CSM TYPICAL LANDMARK TRACKING PROFILE

22 DEG PITCH DOWN FROM  
LOCAL HORIZONTAL ORBITAL  
RATE THROUGHOUT TRACKING.

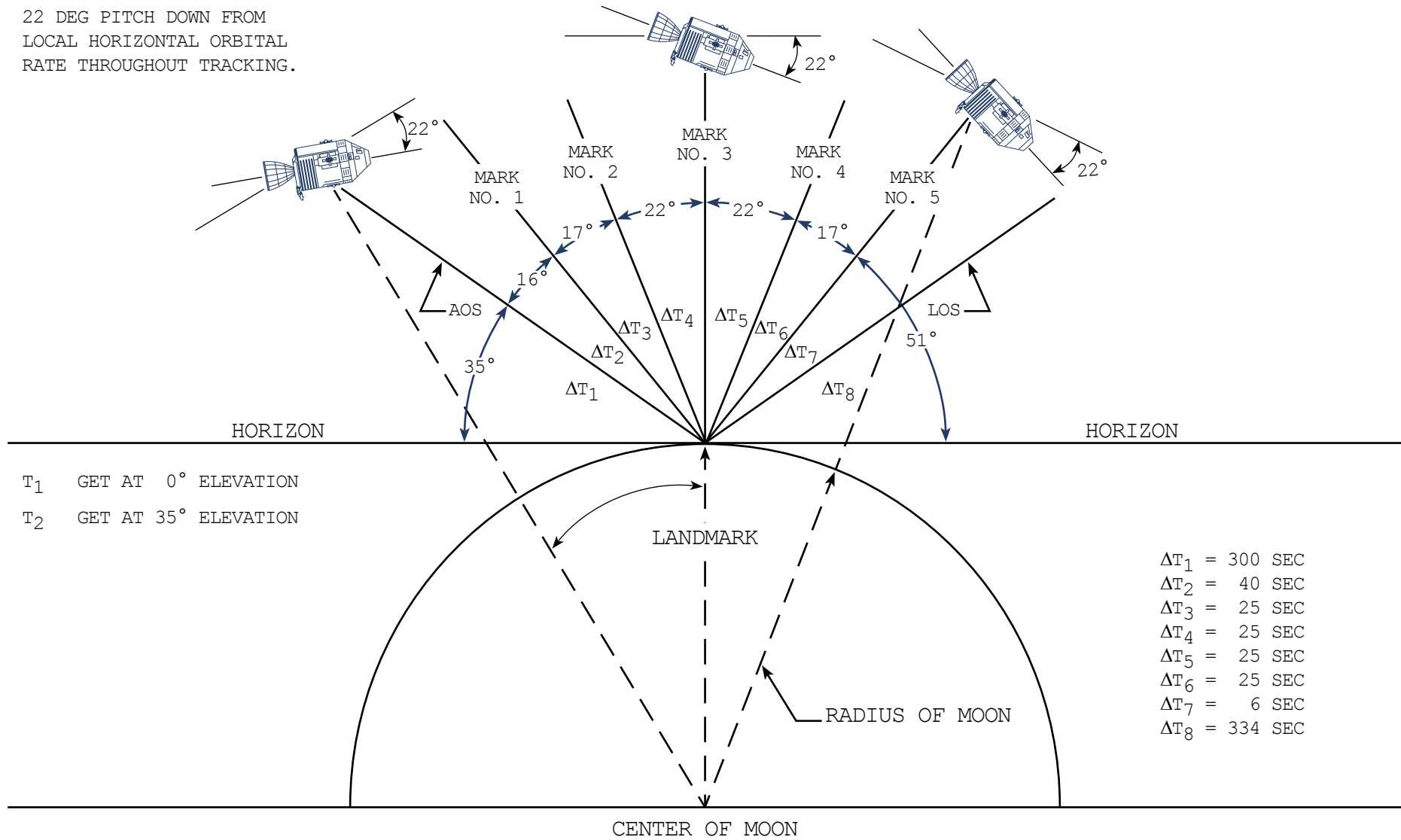

T<sub>1</sub> GET AT 0° ELEVATION  
T<sub>2</sub> GET AT 35° ELEVATION

- $\Delta T_1 = 300 \text{ SEC}$
- $\Delta T_2 = 40 \text{ SEC}$
- $\Delta T_3 = 25 \text{ SEC}$
- $\Delta T_4 = 25 \text{ SEC}$
- $\Delta T_5 = 25 \text{ SEC}$
- $\Delta T_6 = 25 \text{ SEC}$
- $\Delta T_7 = 6 \text{ SEC}$
- $\Delta T_8 = 334 \text{ SEC}$

**CSM  
CMP**

**FLIGHT PLAN**

**LM**

**MCC-H**

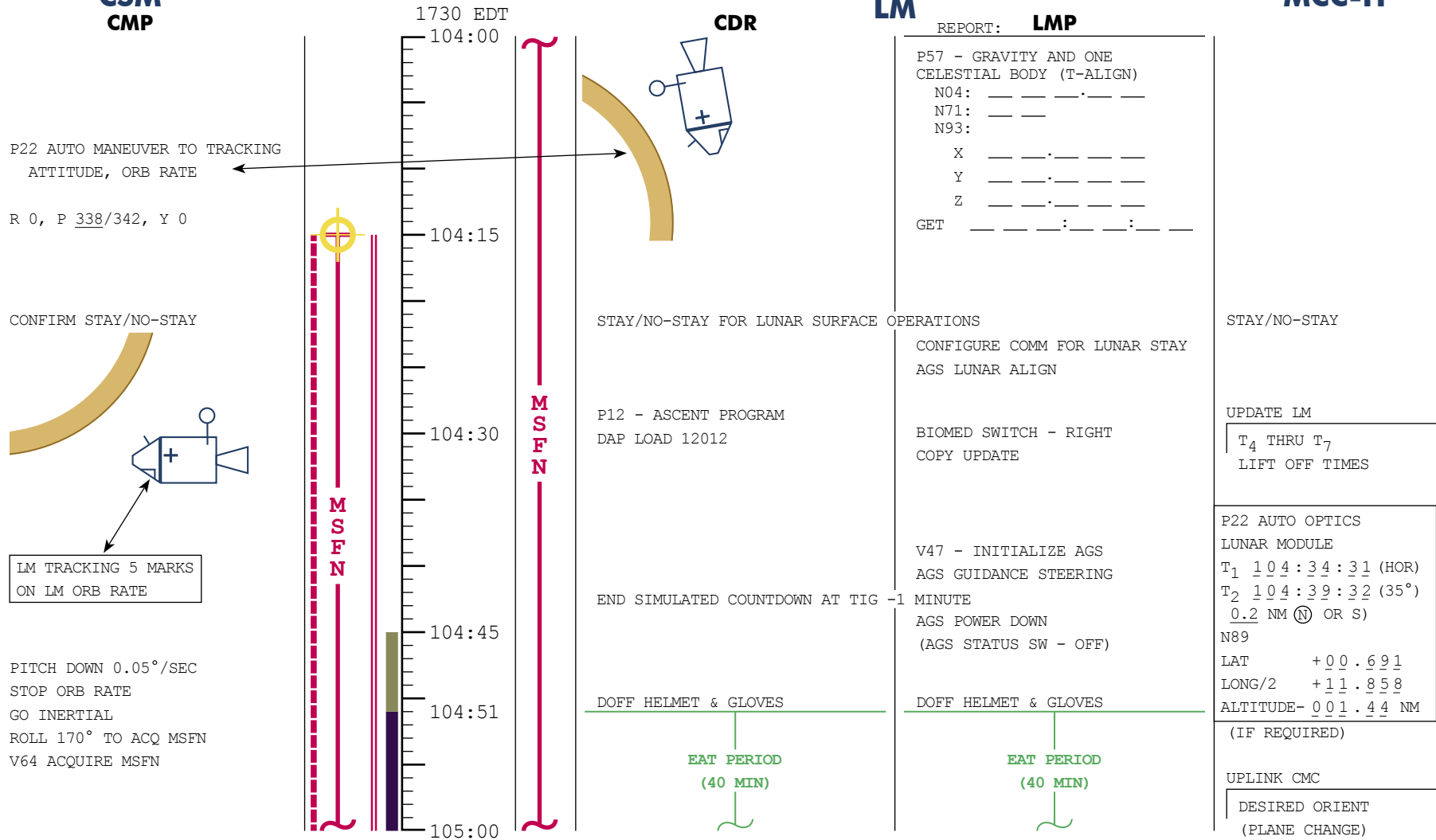

MISSION	EDITION	DATE	TIME	DAY / REV	PAGE
APOLLO 11	FINAL	JULY 1, 1969	104:00 - 105:00	5 / 15	3-71

# FLIGHT PLAN

**CSM  
CMP**

P52 (OPT 1 - PREFERRED)  
GYRO TORQUE TO DESIRED  
ORIENTATION FOR PLANE CHANGE  
(IF PLANE CHANGE IS REQUIRED)  
GDC ALIGN TO IMU

EAT PERIOD  
(1 HOUR)

1830 EDT

105:00

105:26

105:30

105:38

105:44

106:00

REV 16

M  
S  
F  
N

M  
S  
F  
N

**CDR**

EAT PERIOD  
(40 MIN)

CREW STATUS REPORT (RADIATION, MEDICATION)

CONFIGURE SLEEP STATION  
STOW PLSS IN DONNING STATION

REST PERIOD  
(4 HOURS)

**LM**

**LMP**

EAT PERIOD  
(40 MIN)

REST PERIOD  
(4 HOURS)

**MCC-H**

DUMP DSE

MISSION	EDITION	DATE	TIME	DAY / REV	PAGE
APOLLO 11	FINAL	JULY 1, 1969	105:00 - 106:00	5 / 15-16	3-72

# FLIGHT PLAN

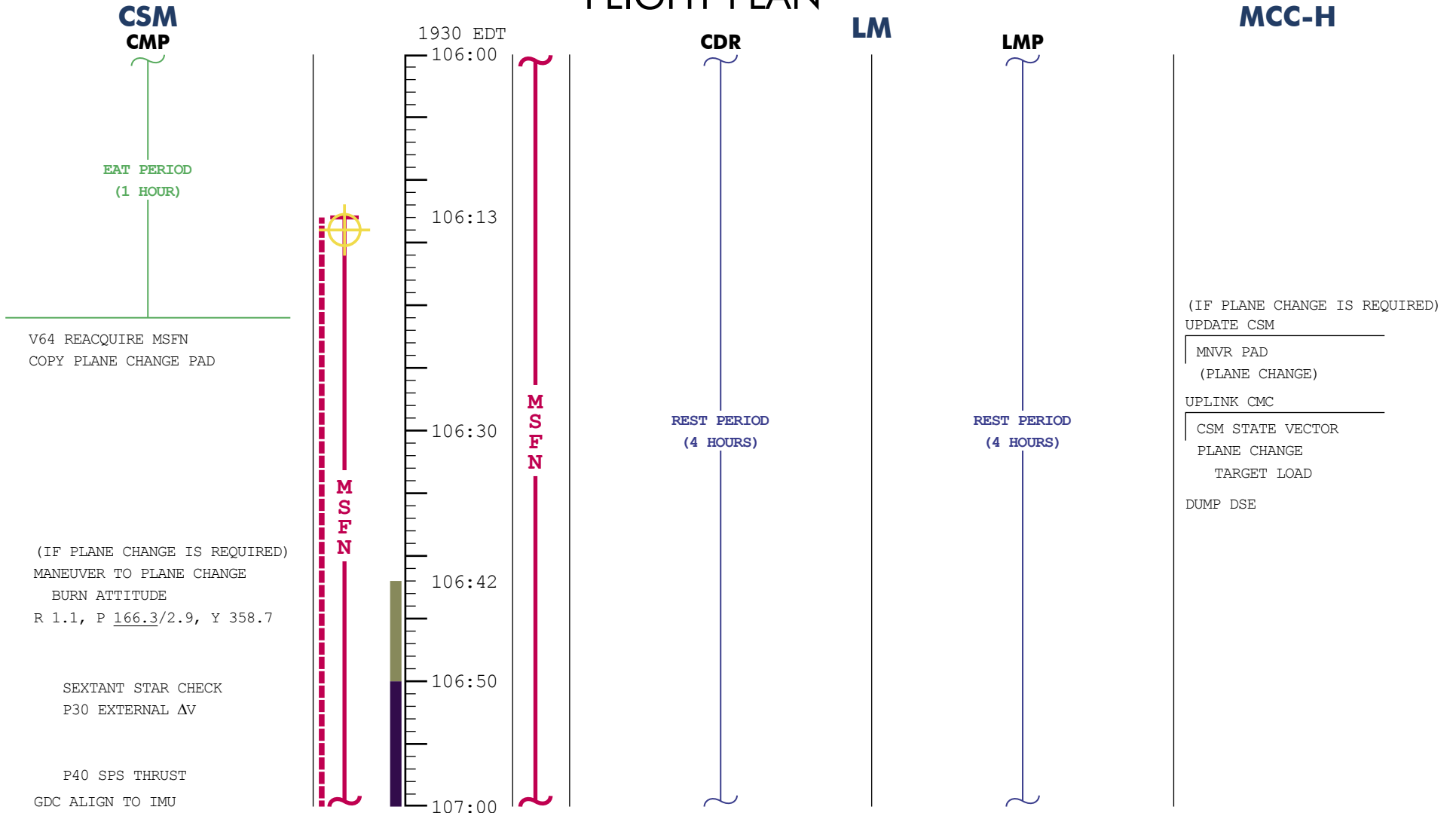

MISSION	EDITION	DATE	TIME	DAY / REV	PAGE
APOLLO 11	FINAL	JULY 1, 1969	106:00 - 107:00	5 / 16	3-73

# FLIGHT PLAN

**CSM  
CMP**

**LM**

**MCC-H**

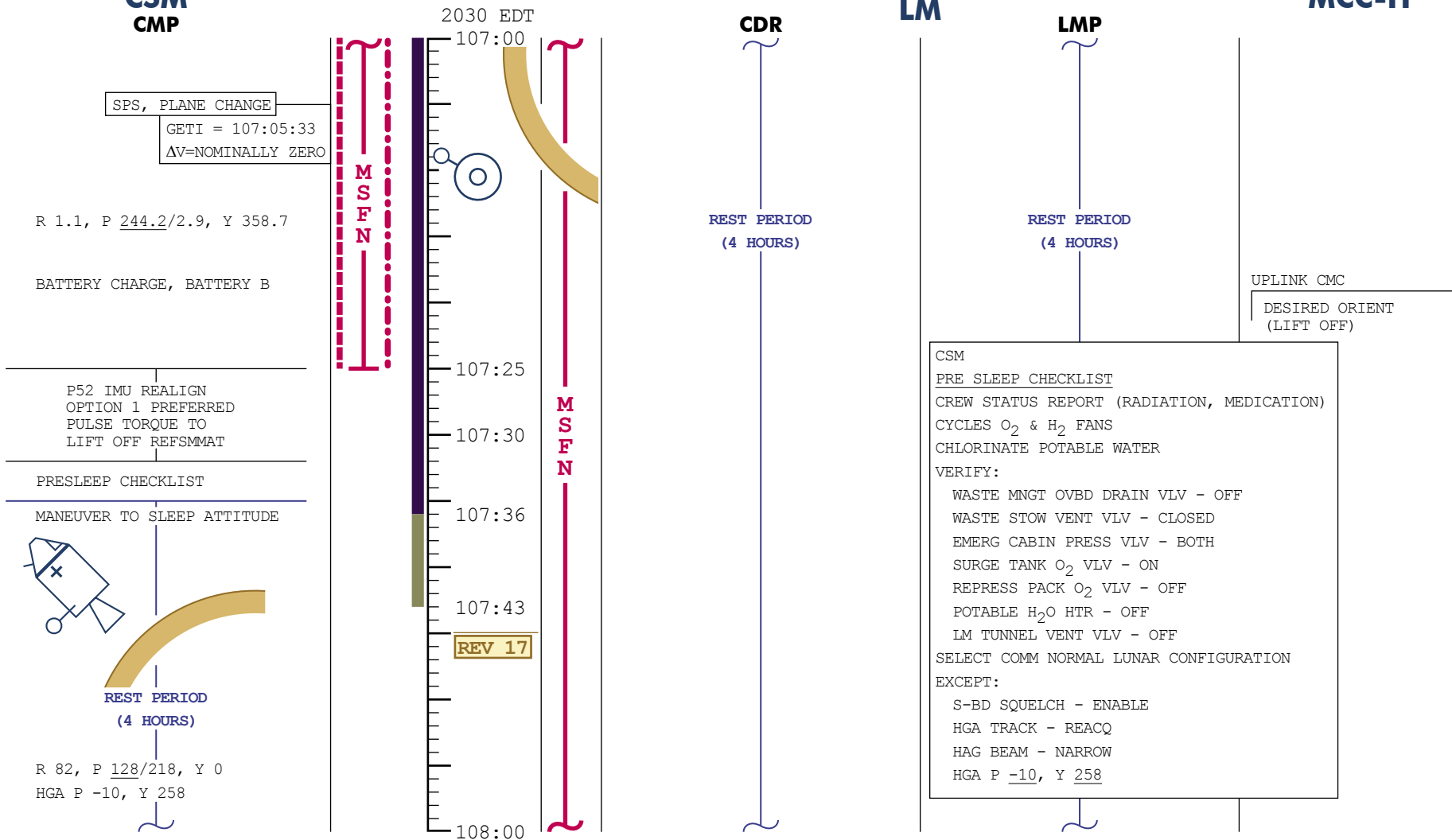

MISSION	EDITION	DATE	TIME	DAY / REV	PAGE
APOLLO 11	FINAL	JULY 1, 1969	107:00 - 108:00	5 / 16-17	3-74

# FLIGHT PLAN

**CSM  
CMP**

**LM**

**MCC-H**

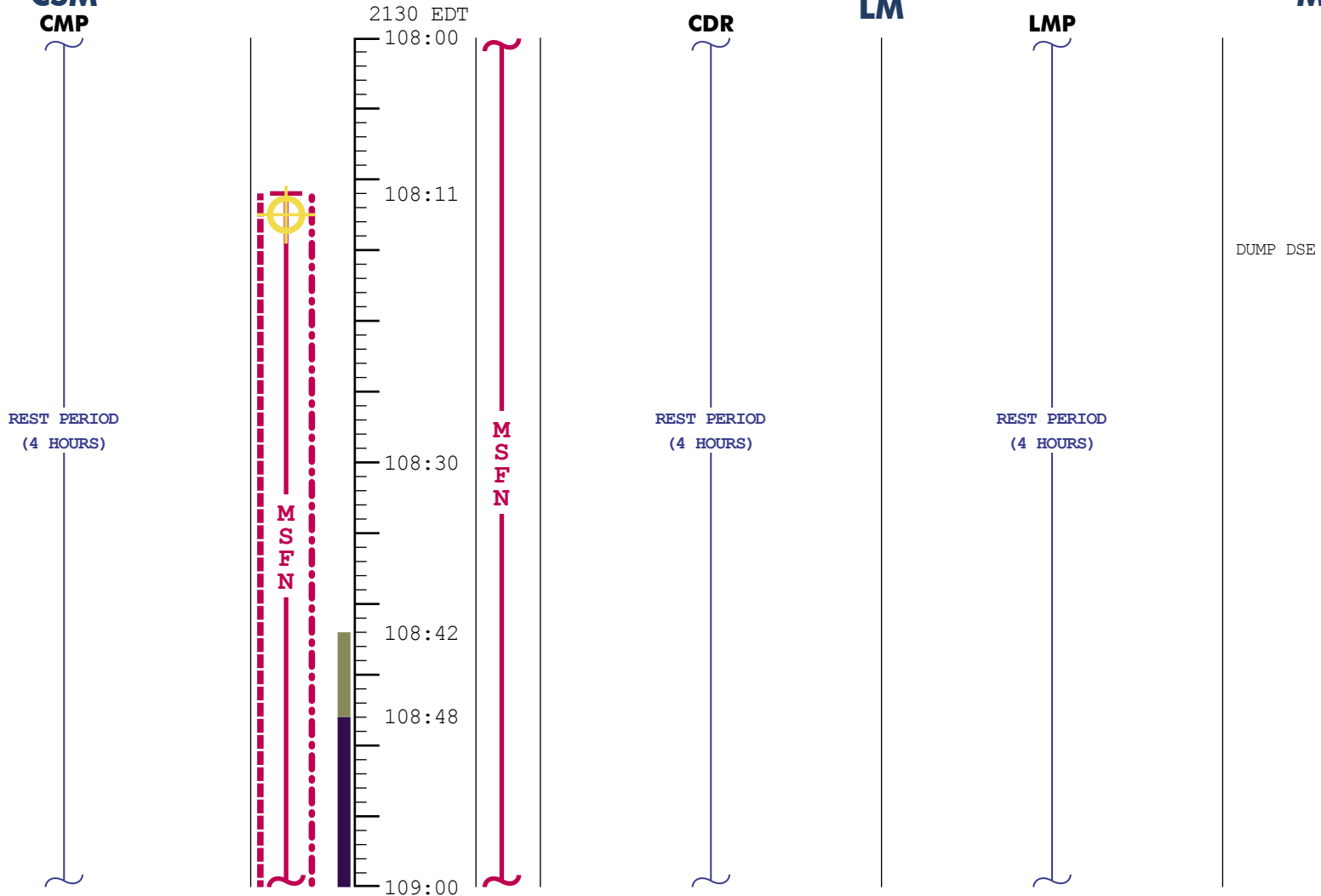

MISSION	EDITION	DATE	TIME	DAY / REV	PAGE
APOLLO 11	FINAL	JULY 1, 1969	108:00 - 109:00	5 / 17	3-75

# FLIGHT PLAN

**CSM  
CMP**

REST PERIOD  
(4 HOURS)

M  
S  
F  
N

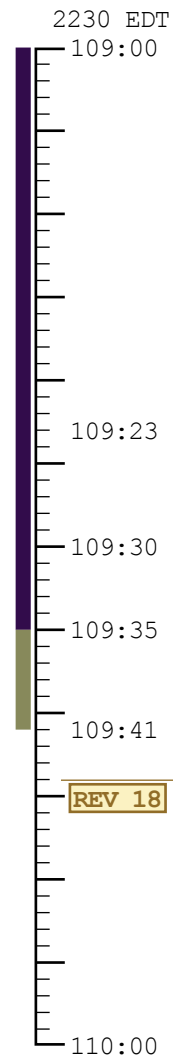

M  
S  
F  
N

**CDR**

REST PERIOD  
(4 HOURS)

EAT PERIOD  
(1 HOUR)

**LM**

**LMP**

REST PERIOD  
(4 HOURS)

EAT PERIOD  
(1 HOUR)

**MCC-H**

MISSION	EDITION	DATE	TIME	DAY / REV	PAGE
APOLLO 11	FINAL	JULY 1, 1969	109:00 - 110:00	5 / 17-18	3-76



# FLIGHT PLAN

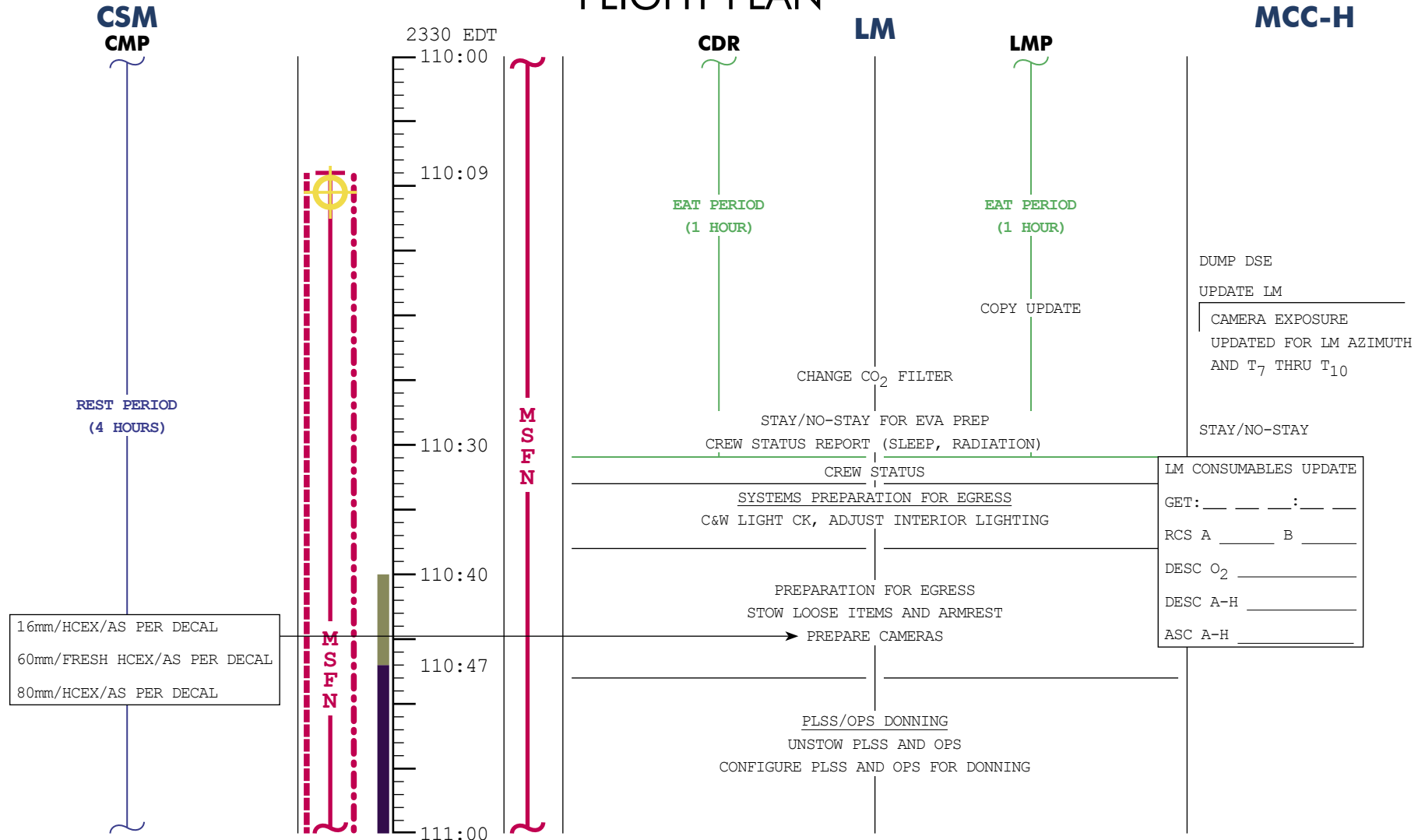

MISSION	EDITION	DATE	TIME	DAY / REV	PAGE
APOLLO 11	FINAL	JULY 1, 1969	110:00 - 111:00	5 / 18	3-77

# FLIGHT PLAN

MCC-H

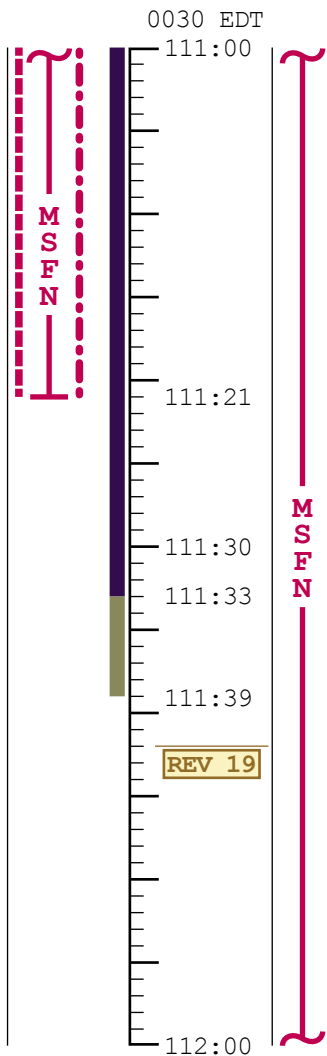
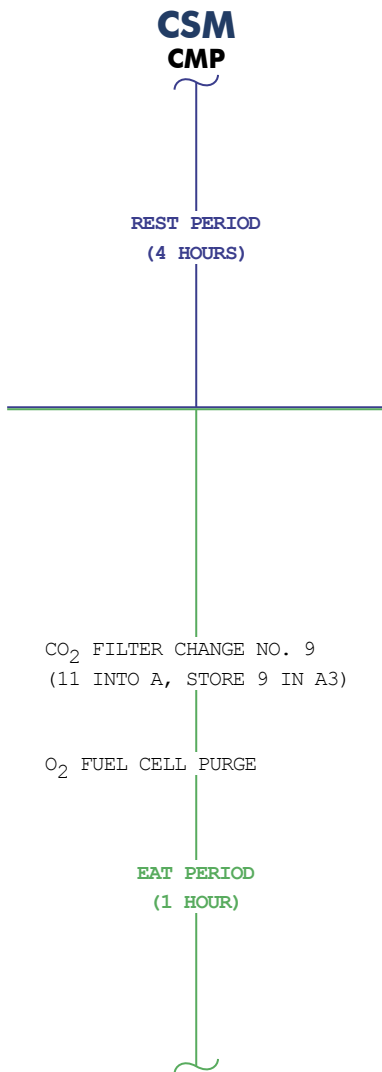

CDR	LM	LMP
		LMP UNSTOW AND DON OVERSHOES ATTACH OPS TO PLSS
		CDR UNSTOW AND DON OVERSHOES ATTACH OPS TO PLSS
		LMP DON PLSS UNSTOW AND CONNECT RCU VERIFY PLSS SWITCH AND VALVE POSITIONS
		PREPARE CDR PLSS FOR DOWNING
		CDR DON PLSS UNSTOW AND CONNECT RCU VERIFY PLSS SWITCH AND VALVE POSITIONS
<u>PLSS/EXTRA VEHICULAR COMM SYSTEM ELECTRICAL CHECKOUT</u> AUDIO SWITCHES CHECK ACTIVATE PLSS COMM SYSTEMS		
FINAL EVA EQUIPMENT PREP FOR EGRESS UNSTOW AND CONNECT OPS O <sub>2</sub> HOSE AND ACTUATOR		
FINAL SYSTEMS PREP FOR EGRESS CONFIRM „GO“ FOR CABIN DEPRESS VERIFY C/B, VALVES AND O <sub>2</sub> /H <sub>2</sub> O QUANTITY		

GO/NO-GO

MISSION	EDITION	DATE	TIME	DAY / REV	PAGE
APOLLO 11	FINAL	JULY 1, 1969	111:00 - 112:00	5 / 18-19	3-78

# FLIGHT PLAN

**CSM  
CMP**

EAT PERIOD  
(1 HOUR)

CREW STATUS REPORT (SLEEP)  
SELECT COMM NORMAL  
LUNAR CONFIGURATION

COPY PAD  
(SEE GET 114:20)

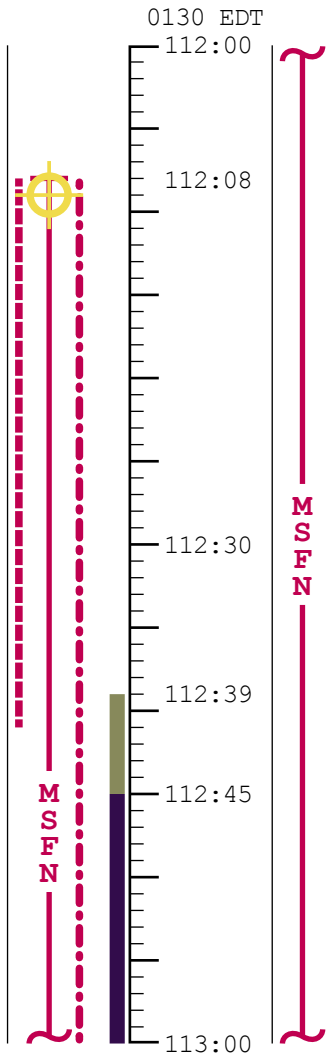

**CDR**

**LM**

**LMP**

**MCC-H**

	PREP FOR CABIN DEPRESS	
	CONNECT OPS O <sub>2</sub> HOSES	
	LMP DON HELMET	
	CDR DON HELMET	DUMP DSE
	CONNECT PLSS H <sub>2</sub> O HOSES	
	DON GLOVES	
<hr/>		
	PRESSURE INTEGRITY CHECK	
	PLSS O <sub>2</sub> ON	START EVA
	SET CHRONOMETER	0+00
FINAL PRE-EVA OPERATIONS DEPRESS CABIN FINAL SYSTEMS CHECKS	OPEN FWD HATCH	
	PLSS H <sub>2</sub> O ON	0+10
INITIAL EVA EGRESS TO PLATFORM RELEASE MESA DESCEND LADDER REST/CHECK EMU SYSTEM	ASSIST AND MONITOR CDR	UPDATE CSM
	TURN TV ON ACT 16mm CAMERA	LM ACQUISITION TIME
ENVIRONMENTAL FAMILIARIZATION CHECK STABIL, MOBIL, EMU	MONITOR CDR	0+20
CONT SAMPLE COLLECTION COLLECT AND STOW SAMPLE	OPERATE 16mm CAMERA	0+30

MISSION	EDITION	DATE	TIME	DAY / REV	PAGE
APOLLO 11	FINAL	JULY 1, 1969	112:00 - 113:00	5 / 19	3-79

**CSM  
CMP**

SET UP CAMERA FOR TRACKING

EL/250/BW-BRKT  
INT (f5.6, 250, INF)

PITCH DOWN 172° TO HEADS DOWN  
FOR LUNAR SURFACE OBSERVATION,  
ORB RATE

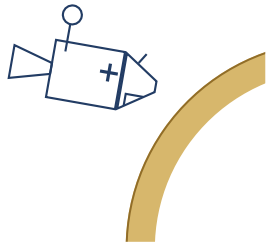

R 180, P 282/44, Y 0

# FLIGHT PLAN

**LM**

**LMP**

**MCC-H**

TIME	CDR	LMP	MCC-H
0230 EDT 113:00	<u>PRELIMINARY CHECKS</u> CK LM STATUS CK LIGHTING VISIBILITY	STILL-CAMERA TO SURFACE FINAL LM CK EVA GO	0+30
	<u>REST</u> MONITOR AND PHOTOGRAPH LMP EGRESS	<u>INITIAL EVA</u> EGRESS DESCEND TO SURFACE	EVA GO 0+40
113:19	<u>TV DEPLOYMENT</u> CAMERA EQPT FROM MESA CARRY TV TO SITE MOUNT TRIPOD, PANORAMA, POSITION FOR EVA PHOTOGRAPH SWC PHOTO BULK SAMPLE AREA	<u>ENVIRONMENT FAMILIARIZATION</u> CK BALANCE, STABILITY, REACH, WALKING, EMU	0+50
113:30 113:32	<u>BULK SAMPLE COLLECTION</u> CAMERA ON MESA PREPARE SRC COLLECT ROCK FRAGMENTS AND LOOSE MATERIAL WEIGH SAMPLE PACK AND SEAL SRC, CONNECT TO LEC REST	<u>EVA AND ENIRON EVAL</u> EVAL EVA CAPABILITY AND EFFECTS EVAL LIGHTING/VISIBILITY AND SURFACE CHARACTERISTICS PHOTO PANORAMA	1+00
113:38 <b>REV 20</b>	<u>LM INSPECTION</u> INSPECT QUAD IV, +Y GEAR EVAL TERRAIN, VISIBILITY INSPECT QUAD III, -Z GEAR PHOTO QUAD II, EASEP OFF LOADING INSPECT, PHOTO -Y GEAR PHOTO PANORAMA TAKE CLOSEUP PHOTOS EASEP DEPLOYMENT	<u>LM INSPECTION</u> PHOTO QUAD I, +Z GEAR PHOTO BULK SAMPLE AREA DEPLOY ALSCC PHOTO QUAD IV, +Y GEAR PHOTO PANORAMA PHOTO QUAD III, -Z GEAR CAMERA TO CDR	1+10 1+20
114:00		<u>EASEP DEPLOYMENTS</u> REMOVE EXPERIMENTS	1+30

MISSION	EDITION	DATE	TIME	DAY / REV	PAGE
APOLLO 11	FINAL	JULY 1, 1969	113:00 - 114:00	5 / 19-20	3-80

**CSM  
CMP**

EL/250/BW-BRKT, INT  
(f5.6, 250, INF)

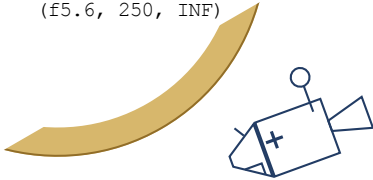

IF CONVENIENT CHANGE  
SHUTTER TO 1/125  
PITCH UP 38°  
ROLL 180° TO HEADS UP  
R 0, P 320/260, Y 0  
PITCH DOWN, PHOTOGRAPH LM  
WHILE TRACKING THROUGH COAS

STOP PITCH AND ROLL 180° TO  
HEADS DOWN ATTITUDE FOR  
SURFACE OBSERVATIONS  
STOP CAMERA

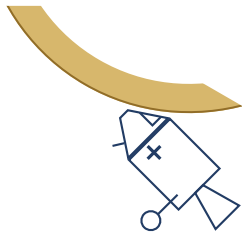

R 180, P 282/185, Y 0  
HGA P -7, Y 183

# FLIGHT PLAN

0330 EDT

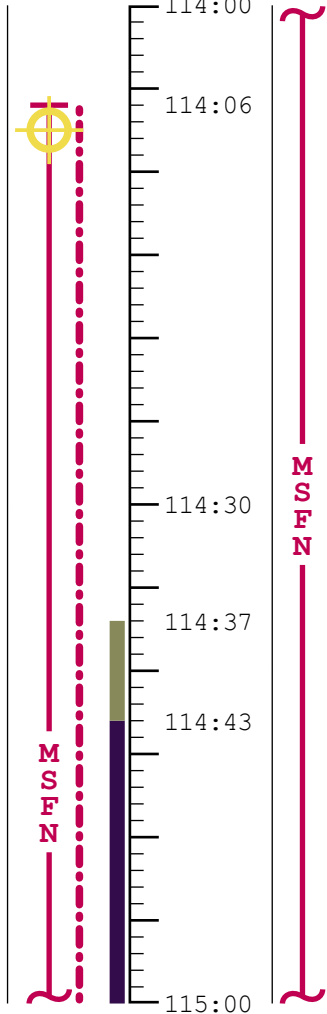

**CDR**

SELECT DEPLOY SITE  
CARRY CAMERAS  
DEPLOY LR<sup>3</sup> EXPERIMENT  
PHOTO EXPERIMENTS

DOCUMENTED SAMPLE COLLECTION

REST/PHOTO LMP  
CLOSE-UP PHOTOS  
TETHER SAMPLE BAG TO LMP  
PHOTO SAMPLING  
UNSTOW GNOMON  
PHOTO DS AREA  
PHOTO SAMPLE COLLECTION  
STOW ALSCC FILM  
COLLECT ENVIRONMENTAL SAMPLES  
RETRIEVE AND STOW SWC  
PACK SRC  
CLOSE AND SEAL SRC  
REST/PHOTO LMP

SRC TRANSFER

TRANSFER BULK SRC AND STILL  
CAMERA MAGAZINE  
PHOTO LMP  
REST  
TRANSFER DS SRC

**LM**

**LMP**

SELECT DEPLOY SITE  
CARRY EXPERIMENTS  
DEPLOY PSE  
TAKE CLOSEUP PHOTOS

DOCUMENTED SAMPLE COLLECTION

MOVE BULK SRC TO STRUTS OR  
FOOT PAD  
PREPARE DS SRC  
  
COLLECT CORE TUBE SAMPLE  
UNSTOW TOOLS  
COLLECT SAMPLES  
STOW ALSCC FILM  
COLLECT ENVIRONMENTAL SAMPLES  
COLLECT LOOSE MATERIAL  
CORE TUBE SAMPLE

EVA TERMINATION

WIPE SUIT AND EMU  
WIPE FEET ON LANDING PAD  
AND LADDER  
ASCEND LADDER  
INGRESS CABIN  
CHECK LM  
OPERATE SEQ CAMERA  
RECEIVE AND STOW SRC  
AND MAGAZINE  
RECEIVE AND STOW SRC

**MCC-H**

1+30

1+40

DUMP DSE

1+50

LM ACQUISITION GET:

\_\_\_ : \_\_\_ : \_\_\_

2+00

2+10

2+20

2+30

MISSION	EDITION	DATE	TIME	DAY / REV	PAGE
APOLLO 11	FINAL	JULY 1, 1969	114:00 - 115:00	5 / 20	3-81

**CSM  
CMP**

PRE SLEEP CHECKLIST  
 CREW STATUS REPORT  
 (RADIATION, MEDICATION)  
 CYCLES O<sub>2</sub> & H<sub>2</sub> FANS  
 CHLORINATE WATER  
 VERIFY:  
 WASTE MNGMT OVBD DRAIN  
 VLV - OFF  
 WASTE STOW VENT VLV - CLOSED  
 EMERG CABIN PRESS VLV - BOTH  
 SURGE TANK O<sub>2</sub> VLV - ON  
 REPRESS PACK O<sub>2</sub> VLV - OFF  
 POTABLE H<sub>2</sub>O HTR - OFF  
 SELECT COMM NORMAL LUNAR  
 CONFIGURATION - EXCEPT:  
 S-BD SQUELCH - ENABLE  
 HGA TRACK - REACQ  
 HAG BEAM - NARROW  
 HGA P -59, Y 355

EAT PERIOD  
(1 HOUR)

# FLIGHT PLAN

0430 EDT

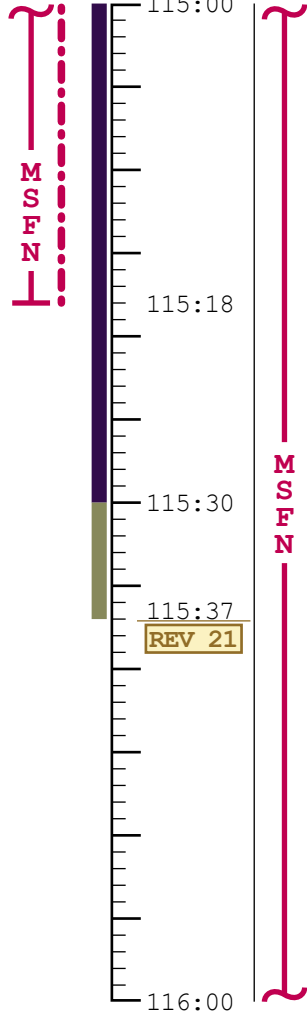

**CDR**

**LM**

**LMP**

**MCC-H**

TERMINATE EVA  
 WIPE FEET ON LANDING PAD  
 AND LADDER  
 ASCEND LADDER  
 CABIN REPRESS

CLOSE FWD HATCH

2+30

PPOST EVA SYSTEMS CONFIGURATION  
 VERIFY CAUTION LIGHTS OFF  
 DISCONNECT RCU  
 DISCONNECT OPS O<sub>2</sub> HOSES  
 CONNECT LM O<sub>2</sub> HOSES (TV-OFF)  
 CONFIGURE VALVES AND CIRCUIT BREAKERS  
 DISCONNECT PLSS H<sub>2</sub>O HOSES  
 SWITCH TO LM COMM SYSTEM

2+40  
END EVA

PLSS/OPS DOFFING  
 REMOVE LMP RCU  
 OPS CHECK  
 STOW PLSS/OPS ON CABIN FLOOR  
 REMOVE CDR RCU  
 STOW PLSS/OPS ON CABIN FLOOR

80mm/HCEX/EVA CARD #1  
 3 FRAMES EACH, FAR & NEAR  
 FIELD (FOCUS 50')  
 AND  
 80mm/BW/EVA CARD #1  
 3 FRAMES EACH, FAR & NEAR  
 FIELD (FOCUS 20')

FINAL SYSTEMS CONFIGURATION

PREP FOR EQUIPMENT JETTISON

REPORT PLSS FEEDWATER  
 REMOVE OPS FROM PLSS

COPY REPORT

MISSION	EDITION	DATE	TIME	DAY / REV	PAGE
APOLLO 11	FINAL	JULY 1, 1969	115:00 - 116:00	5 / 20-21	3-82

# FLIGHT PLAN

**MCC-H**

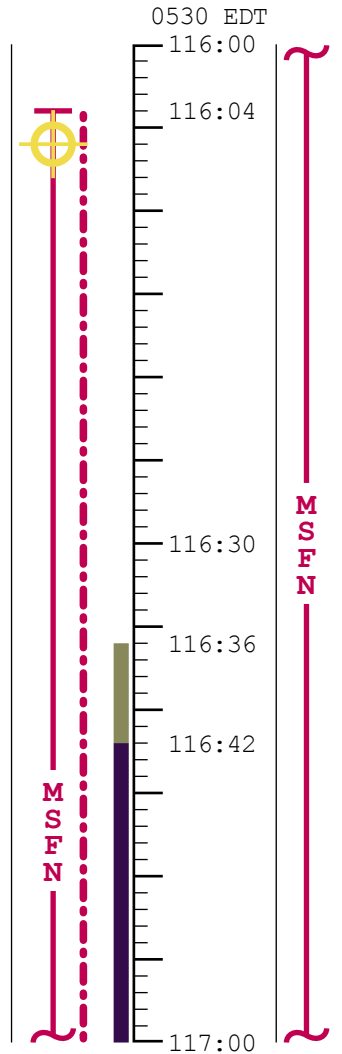
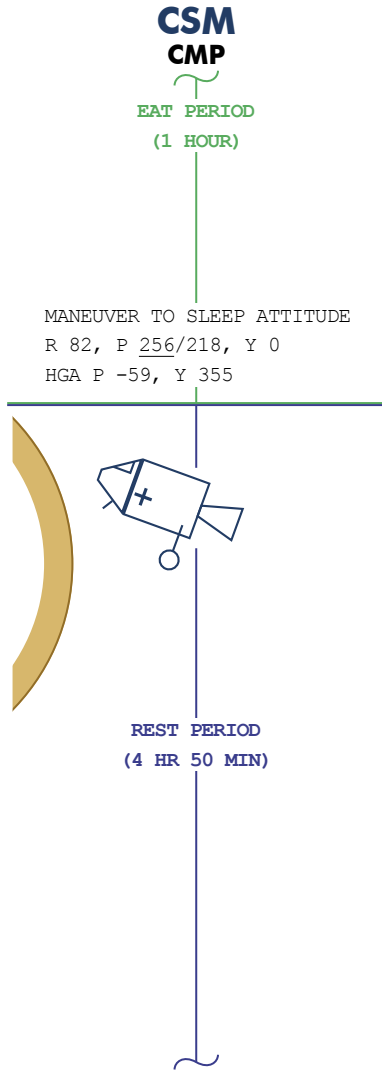

CDR	LM	LMP
	STOW EQUIPMENT IN LHSSC	
	PRESSURE INTEGRITY CHECK	
	CHECK VALVE POSITIONS	
	VERIFY GAGE READINGS	
	CABIN DEPRESS	
	OPEN RELIEF AND DUMP VALVES	
	HATCH OPENING	
	EQUIPMENT JETTISON	
	JETTISON 2 PLSS, LHSSC AND 1 ARMREST	
	CABIN REPRESS	
	RELIEF AND DUMP VALVES - AUTO	
	VERIFY MASTER ALRM AND WARN LIGHTS ON	
	POST EVA SYSTEMS CONFIGURATION	
	FINAL SYSTEMS CONFIGURATION	
	POST EVA CABIN CONFIGURATION	
	STOW EQUIPMENT	
	RECONFIGURE CAMERAS	
EAT PERIOD (40 MIN)		EAT PERIOD (40 MIN)

DUMP DSE

UPDATE LM  
T<sub>10</sub> THRU T<sub>13</sub>

MISSION	EDITION	DATE	TIME	DAY / REV	PAGE
APOLLO 11	FINAL	JULY 1, 1969	116:00 - 117:00	5 / 21	3-83

# FLIGHT PLAN

**CSM  
CMP**

**LM**

**MCC-H**

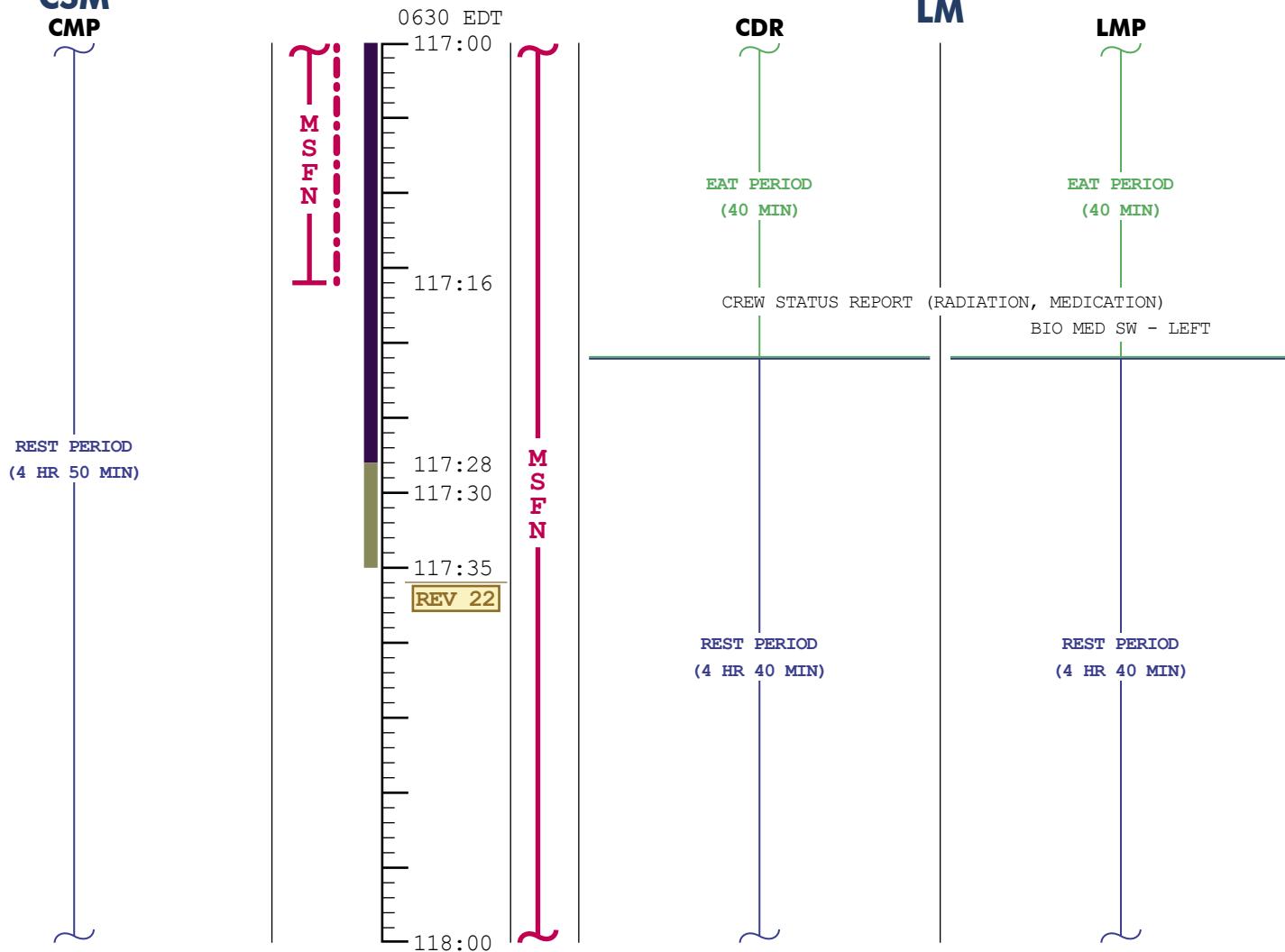

MISSION	EDITION	DATE	TIME	DAY / REV	PAGE
APOLLO 11	FINAL	JULY 1, 1969	117:00 - 118:00	5 / 21-22	3-84



# FLIGHT PLAN

**CSM  
CMP**

REST PERIOD  
(4 HR 50 MIN)

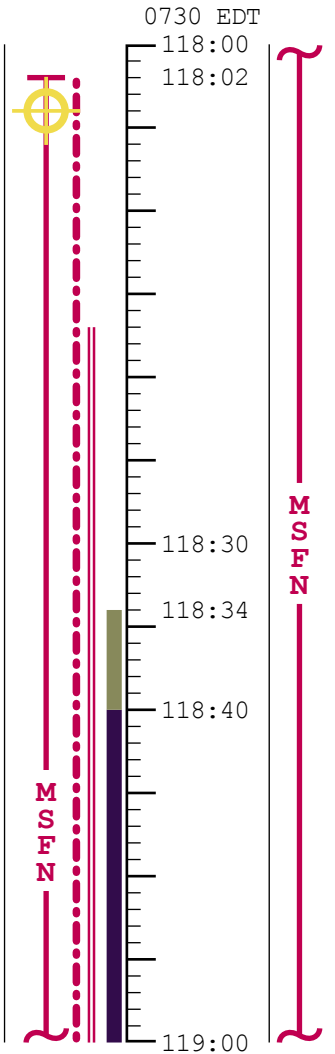

**CDR**

REST PERIOD  
(4 HR 40 MIN)

**LM**

**LMP**

REST PERIOD  
(4 HR 40 MIN)

**MCC-H**

DUMP DSE

MISSION	EDITION	DATE	TIME	DAY / REV	PAGE
APOLLO 11	FINAL	JULY 1, 1969	118:00 - 119:00	5 / 22	3-85

# FLIGHT PLAN

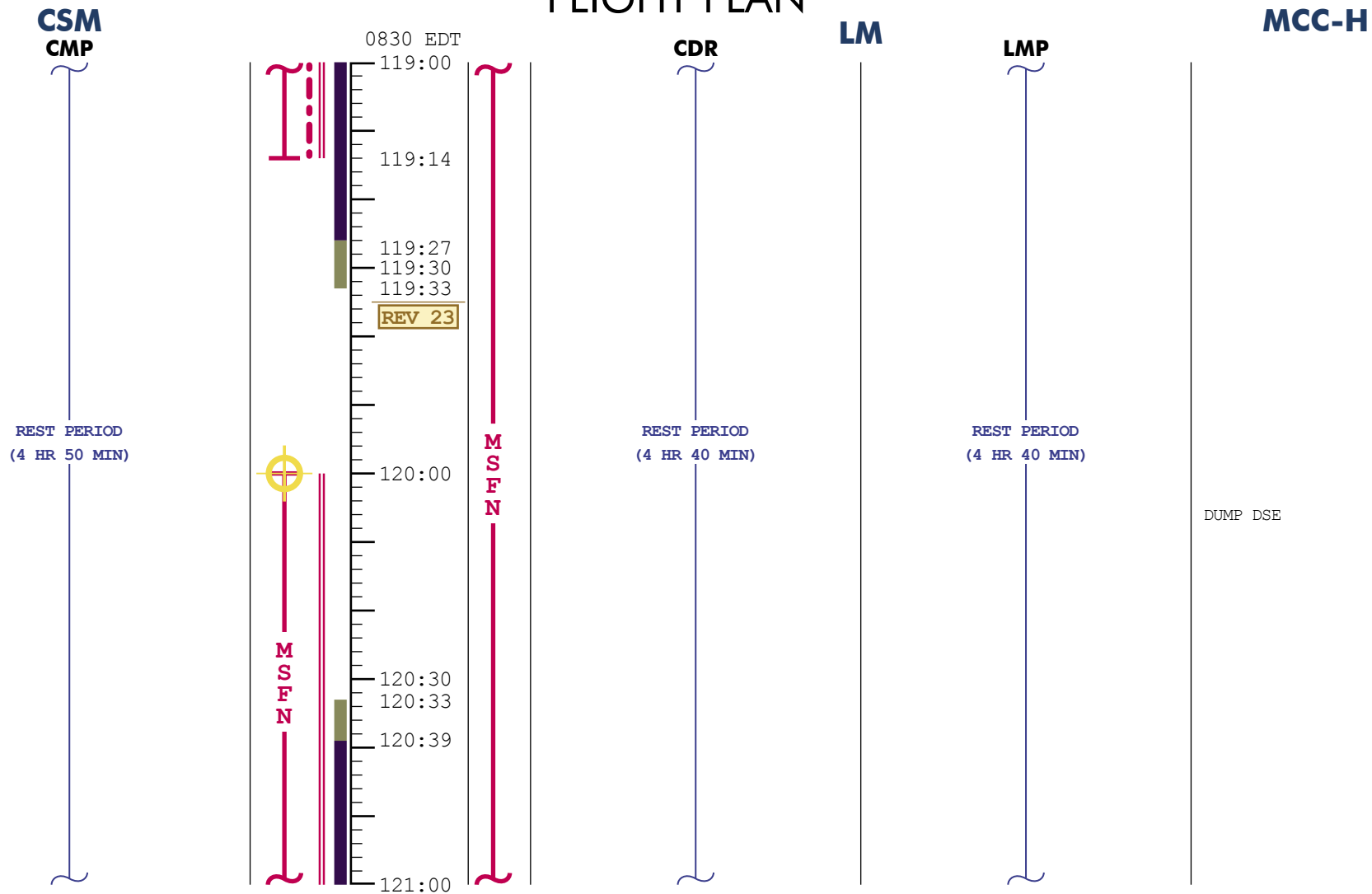

MISSION	EDITION	DATE	TIME	DAY / REV	PAGE
APOLLO 11	FINAL	JULY 1, 1969	119:00 - 121:00	5 / 22-23	3-86

# FLIGHT PLAN

MCC-H

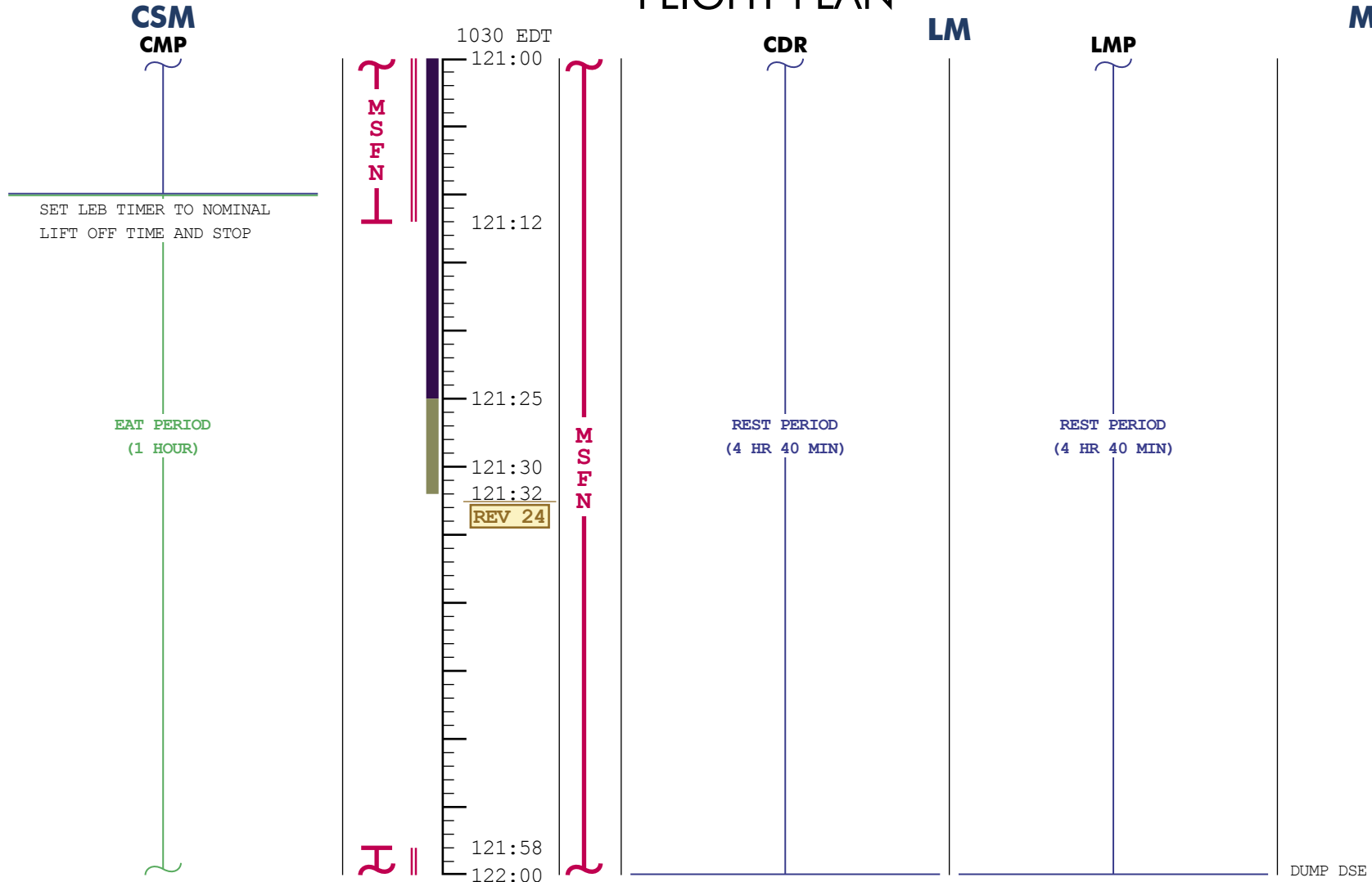

MISSION	EDITION	DATE	TIME	DAY / REV	PAGE
APOLLO 11	FINAL	JULY 1, 1969	121:00 - 122:00	5 / 23-24	3-87

**CSM  
CMP**

SELECT COMM: NORMAL LUNAR  
CONFIGURATION  
CREW STATUS REPORT (SLEEP)

V45 RESET LUNAR SURFACE FLAG

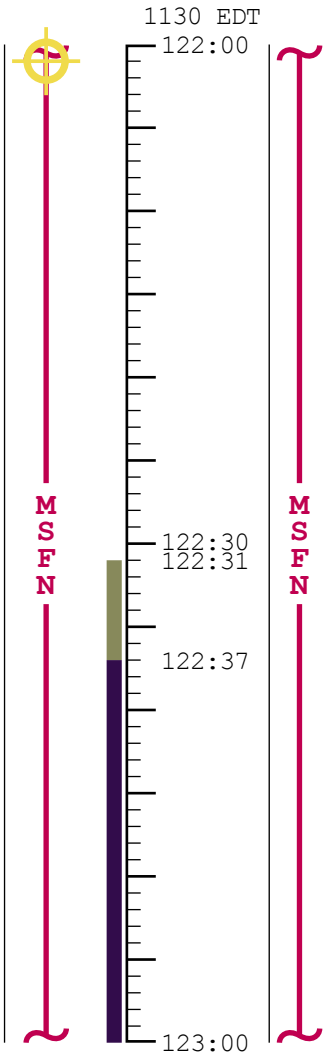

# FLIGHT PLAN

**CDR**

CREW STATUS REPORT (SLEEP)  
RR - ON, SELF TEST

EAT PERIOD  
(35 MIN)

**LM**

**LMP**

AGS TURN ON, SELF TEST  
AND SYSTEM TESTS  
INITIALIZE AGS TIME  
REPORT BIAS TO MCC-H

REPORT:

P57 - GRAVITY AND ONE  
CELESTIAL BODY (REFSMMAT)

N04: \_ \_ \_ . \_ \_ \_

N71: \_ \_ \_

N93: \_ \_ \_

X \_ \_ \_ . \_ \_ \_

Y \_ \_ \_ . \_ \_ \_

Z \_ \_ \_ . \_ \_ \_

GET \_ \_ \_ : \_ \_ \_ : \_ \_ \_

EAT PERIOD  
(35 MIN)

**MCC-H**

COPY TIME BIAS

UPLINK LGC

CSM STATE VECTOR  
(INSERTION +18 MIN)  
PGNCS GYRO COMP  
(IF REQUIRED)

UPLINK CMC

CSM STATE VECTOR  
(INSERTION +18 MIN)  
NOMINAL LM S. V.  
(INSERTION +18 MIN)

MISSION	EDITION	DATE	TIME	DAY / REV	PAGE
APOLLO 11	FINAL	JULY 1, 1969	122:00 - 123:00	6 / 24	3-88

**CSM  
CMP**

COPY CONSUMABLES UPDATE

O<sub>2</sub> FUEL CELL PURGE

SET UP CAMERA FOR DOCKING  
16mm/18/CEX-BRKT  
MIR (f8, 250, INF) 6 fps

RR TRANSPONDER - PWR

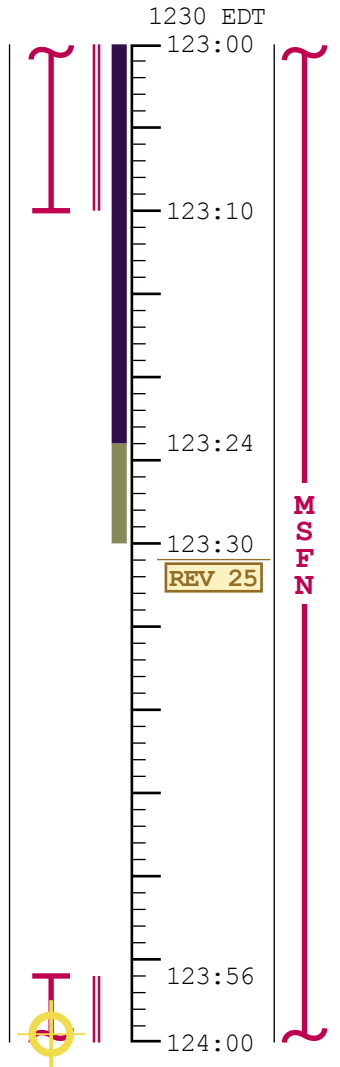

# FLIGHT PLAN

**CDR**

COPY CONSUMABLES UPDATE

RCS HOT FIRE

**LM**

COPY ASCENT PAD  
LOAD PAD DATA

VERIFY AGS:  
AZIMUTH CORRECTION = 0  
H = 60,000 FT  
H DOT = 32 FPS  
NO S-BAND YAW MNVR  
ORBIT INSERTION MODE  
SET CAMERA FOR ASCENT  
16mm/HCEX/OVERHEAD  
MIR (f4, 500, INF) 12 fps

REPORT:

P57 - GRAVITY AND ONE  
CELESTIAL BODY (T-ALIGN)

N04: \_\_\_\_\_  
N71: \_\_\_\_\_  
N93: \_\_\_\_\_  
X \_\_\_\_\_  
Y \_\_\_\_\_  
Z \_\_\_\_\_

GET \_\_\_\_\_:\_\_\_\_\_:

ENTER AGS LUNAR ALIGN

**LMP**

UPDATE LM

ASCENT PAD

CONSUMABLE UPDATE  
(Δ FROM NOMINAL)

GET: \_\_\_\_\_:\_\_\_\_\_

RCS TOT \_\_\_\_\_

A \_\_\_\_\_

B \_\_\_\_\_

C \_\_\_\_\_

D \_\_\_\_\_

H<sub>2</sub> TOT \_\_\_\_\_

O<sub>2</sub> TOT \_\_\_\_\_

LM CONSUMABLES UPDATE

GET: \_\_\_\_\_:\_\_\_\_\_

RCS A \_\_\_\_\_ B \_\_\_\_\_

DESC O<sub>2</sub> \_\_\_\_\_

DESC A-H \_\_\_\_\_

ASC A-H \_\_\_\_\_

MISSION	EDITION	DATE	TIME	DAY / REV	PAGE
APOLLO 11	FINAL	JULY 1, 1969	123:00 - 124:00	6 / 24-25	3-89

**CSM  
CMP**

V64 ACQUIRE MSFN

VHF RANGING  
MNVR TO SUPPORT LIFT OFF  
R 0, P 250/207, Y 0

PITCH DOWN, 0.2°/SEC

CONFIRM INSERTION

VHF RANGING

REPORT:

P52 - (LIFT OFF REFSMMAT) OPTION 3
N71: _ _ , _ _ _
N05: _ _ _ . _ _ _
N93:
X _ _ . _ _ _ _
Y _ _ . _ _ _ _
Z _ _ . _ _ _ _
GET _ _ _ : _ _ : _ _

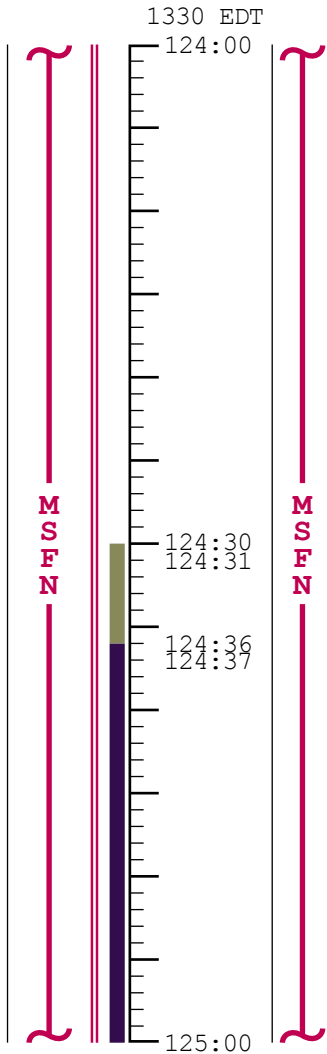

# FLIGHT PLAN

**CDR**

LOAD DAP - 12012  
DON HELMET AND GLOVES  
P12 ASCENT PROGRAM  
RR - ON

PRELAUNCH SWITCH CK  
VERIFY RESTRAINTS

TIG -5 SEC, ABORT STAGE

APS, LIFT OFF

RR LOCK ON, MODE II

ORBIT INSERTION

RR - OFF  
VERIFY INSERTION VEL

P52 - (LIFT OFF REFSMMAT) OPTION 3
N71: _ _ , _ _ _
N05: _ _ _ . _ _ _
N93:
X _ _ . _ _ _ _
Y _ _ . _ _ _ _
Z _ _ . _ _ _ _
GET _ _ _ : _ _ : _ _

RR - ON

**LM**

DON HELMET AND GLOVES

GO/NO-GO FOR PGNCs  
ASCENT GUIDANCE AND  
LIFT OFF THIS REV  
PRELAUNCH SWITCH CK  
VERIFY RESTRAINTS

LIFT OFF COMM  
START 16mm CAMERA  
V47 INITIALIZE AGS  
AGS GUIDANCE STEERING

TIG: 124:23:26  
BT: 7 MIN 18 SEC  
ΔV: 6060 FPS  
ORBIT: 60 KFT x 45 NM

P00 - DOWNLINK LM S. V.  
STOP 16mm CAMERA  
ECS CHECK  
V48 LOAD DAP N46, 12002  
V56, V41 - RR - OFF  
TURN ON TRACK LIGHT

V93 (BEFORE FIRST MARK)  
V80, V47 INITIALIZE AGS  
P32 CSI PRETHRUST

**LMP**

**MCC-H**

UPDATE LM  
GO/NO-GO

LIFT OFF -6 MIN  
DISABLE S-BAND RELAY

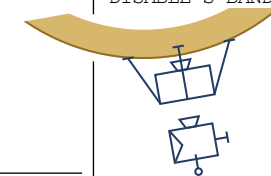

LM FDAI: R 0, P 0, Y 0

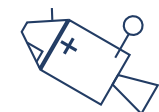

CSM: R 0, P 320/207, Y 0

UPLINK CMC

LM STATE VECTOR



LM FDAI: R 0, P 257.3, Y 0

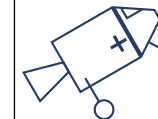

CSM: R 0, P 235/119, Y 0

MISSION	EDITION	DATE	TIME	DAY / REV	PAGE
APOLLO 11	FINAL	JULY 1, 1969	124:00 - 125:00	6 / 25	3-90

# FLIGHT PLAN

**CSM  
CMP**

VHF RANGING  
P40  
SPS CHECKLIST

CSI, BACKUP  
P76 TARGET ΔV

P20 AUTO MANEUVER  
TO SEXTANT TRACK

VHF RANGING

P76 TARGET ΔV  
(LM PC BURN DATA)

SEXTANT TRACKING  
VHF RANGING

1430 EDT

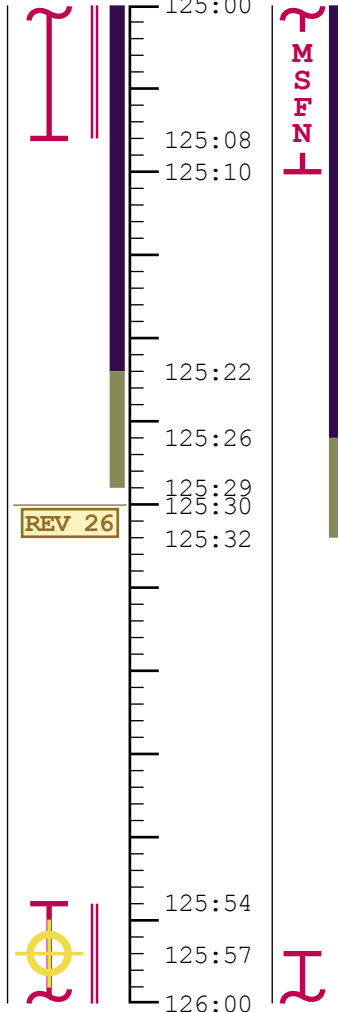

**M  
S  
F  
N**

**CDR**

P20 RENDEZVOUS NAVIGATION  
ACQUIRE AND TRACK CSM  
MAINTAIN RR  
TRACKING ATTITUDE  
SLEW STEERABLE ANT  
ANT P 58, Y -38

V83 SET ORDEAL

P41 RCS THRUSTING

VERIFY RESIDUALS

Z AXIS BORESIGHT

MAINTAIN RR AND  
VHF TRACKING ATTITUDE

P41 RCS THRUSTING

**LM**

**LMP**

V32 - MARKS = 5  
V32 - MARKS = 10  
RCS TEMP/PRESS/QTY CK  
AFT OMNI, PCM LBR  
FINAL CSI COMPUTATION  
V90 OUT OF PLANE  
V47 INITIALIZE AGS (PCM-HI)  
CSI DATA TO CSM (PCM-LO)  
LOAD AGS ΔV

RCS, CSI  
TIG: 125:21:19  
BT: 45 SEC  
ΔV: 49.5 FPS

V76, V67, VHF RANGING  
P33 CDH PRETHRUST  
V93 MARKS = 4  
V32 MARKS = 3  
V90 OUT OF PLANE  
V32 MARKS = 10  
P30 EXTERNAL ΔV  
V90 OUT OF PLANE  
LOAD AGS ΔV

RCS, PLANE CHANGE  
TIG: 125:50:28  
ΔV=NOMINALLY ZERO  
V76, P33 CDH PRETHRUST

**MCC-H**

CSM: R 0, P 180/271, Y 0

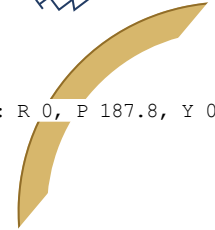
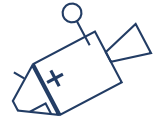

LM FDAI: R 0, P 187.8, Y 0

MISSION	EDITION	DATE	TIME	DAY / REV	PAGE
APOLLO 11	FINAL	JULY 1, 1969	125:00 - 126:00	6 / 25-26	3-91

**CSM  
CMP**

V90 YDOT  
TRANSMIT YDOT TO LM  
P33 FINAL COMPUTATION

P41  
CDH BACKUP

P76 TARGET ΔV

P20 AUTO MANEUVER  
TO SEXTANT TRACK  
VHF RANGING

SEXTANT TRACKING  
VHF RANGING

P34 TPI

SET EVENT TIMER  
P40 ΔV THRUST  
SPS CHECKLIST

P76 TARGET ΔV

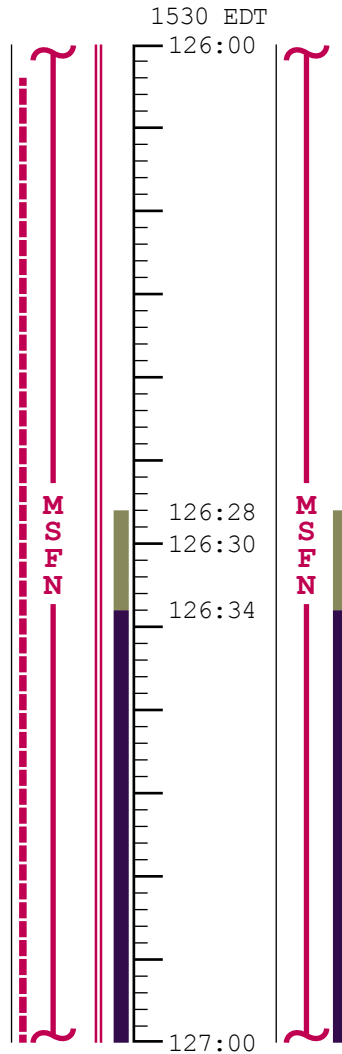

# FLIGHT PLAN

**CDR**

MAINTAIN RR AND  
VHF TRACKING ATTITUDE

V83 SET ORDEAL  
P41 RCS THRUSTING

MAINTAIN RR AND  
VHF TRACKING ATTITUDE

P41 RCS THRUSTING  
COUNTDOWN TO CSM

VERIFY RESIDUALS

**LM**

**LMP**

V93 MARKS = 4  
ACQUIRE MSFN S-BAND  
STEERABLE ANTENNA  
P -58 Y -38  
V32 MARKS = 5  
RCS TEMP/PRESS/QTY CK  
ECS CHECK  
FINAL COMPUTATION  
V90 OUT OF PLANE  
COPY CSM YDOT, LOAD NEG  
V47 INITIALIZE AGS

TIG: 126:19:37  
BT: 1.9 SEC  
ΔV: 4.3 FPS

V76, P34 TPI PRETHRUST  
V93 MARKS = 4  
V32 MARKS = 3

V32 MARKS = 10

RCS TEMP/PRESS/QTY CK  
ECS CHECK

FINAL COMPUTATION  
COPY CSM YDOT, LOAD NEG  
V47 INITIALIZE AGS  
COPY CSM TPI SOLUTION  
LOAD AGS ΔV

TIG: 126:58:08  
BT: 22.4 SEC  
ΔV: 24.8 FPS

**MCC-H**

LM FDAI: R 0, P 352.8, Y 0



CSM: R 180, P 264/177, Y 0

CSM: R 0, P 208/9, Y 0

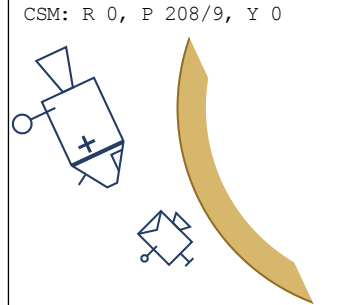

LM FDAI: R 0, P 274.6, Y 0

MISSION	EDITION	DATE	TIME	DAY / REV	PAGE
APOLLO 11	FINAL	JULY 1, 1969	126:00 - 127:00	6 / 26	3-92



**CSM  
CMP**

P20 AUTO MNVR  
P35 TPM PRETHRUST  
SXT AND VHF TRACKING

P41  
MCC1 BACKUP  
P76 TARGET ΔV

SXT AND VHF TRACKING

P35 TPM PRETHRUST  
P41  
MCC2 BACKUP  
P76 TARGET ΔV  
V89 MANEUVER TO COAS  
TRACKING ATTITUDE  
DON HELMET & GLOVES

START 16mm CAMERA  
DOCK CHECKLIST  
LOAD DAP R1 = 61112  
R2 = 11111  
FOR LM ASCENT STAGE DOCKING  
CMC - AUTO

# FLIGHT PLAN

**LM**

**MCC-H**

		1630 EDT	CDR	LMP
		127:00	ANT P Y	V76, V93 (BEFORE FIRST MARK) P35 TPM PRETHRUST AFT OMNI, PCM LBR
		127:06	P41 RCS THRUSTING	COMPUTE MCC1 (TPI +15)
			RCS, MCC1	TIG: 127:13:08
		127:21	MAINTAIN LOS CSM	V76, V93 (BEFORE FIRST MARK) P35 TPM PRETHRUST
		127:27	P41 RCS THRUSTING	COMPUTE MCC2 (TPI +30)
		127:30	RCS, MCC2	TIG: 127:28:08
		127:30	V63 RR SELF TEST P47 THRUST MONITOR	P00
			RCS BRAKING	
			ΔT FROM	ΔV
			GET TPI	BT SEC FT/SEC
			RANGE	RANGE RATE
			NM	FT/SEC
		127:36:57	28:49	NOMINALLY NOT PERFORMED
		127:39:24	41:16	10.8 12.0 2724 -19.7
		127:40:37	42:29	8.8 9.8 1370 -9.8
		127:42:16	44:08	4.3 4.8 469 -4.8
		127:43:35	45:27	4.2 4.7 89 -0.2
		127:53		
		128:00		

MISSION	EDITION	DATE	TIME	DAY / REV	PAGE
APOLLO 11	FINAL	JULY 1, 1969	127:00 - 128:00	6 / 26-27	3-93

**CSM  
CMP**

CONTACT: CMC - FREE NULL RATES

ROLL RIGHT 60°  
PITCH UP 53°

GO INERTIAL  
PRESS CSM TO 5.5 PSIA  
DISABLE JETS B3 & C4  
ADJUST O<sub>2</sub> FLOW TO .6 LBS/HR  
PRESS TUNNEL TO 3 PSID FOR  
LEAK CK,  
THEN EQUALIZE CM/LM ΔP  
INFORM LM WHEN PRESS EQUAL  
REMOVE HATCH AND STOW  
VERIFY LATCHES  
PASS BAGS & BRUSH TO LM



1730 EDT

128:00

128:26

128:30

128:32

129:00

# FLIGHT PLAN

**CDR**

**LM**

**LMP**

**MCC-H**

DOCKING 128:00

CSM: R 300, P 4/332, Y 0

LM FDAI: R 0, P 152, Y 0

DOFF HELMET & GLOVES  
AND TEMPORARILY STOW  
OPEN LM HATCH  
REMOVE AND STOW PROBE & DROGUE

DOFF HELMET & GLOVES  
AND TEMPORARILY STOW  
ASSIST CDR

CSM: R 0, P 102/25, Y 0  
HGA: P -53, Y 3

RETRIEVE THE FOLLOWING ITEMS  
FROM CSM:  
HELMET STOWAGE BAGS (2)  
SRC (ROCK BOX) BAGS (2)  
CSC (GRAB SAMPLE) BAG (1)  
70mm MAGAZINE BAG (1)  
CLOSEUP MAGAZINE BAG (1)  
VACUUM BRUSH & HOSE  
GLOVE BAGS (2)

TEMPORARILY STOW  
BAGS AND BRUSH

LM FDAI: R 0, P 205, Y 60  
ANT: P 173, Y 72

CONFIGURE CDR SUIT LOOP FOR  
VACUUM CLEANING

ASSIST CDR

MISSION	EDITION	DATE	TIME	DAY / REV	PAGE
APOLLO 11	FINAL	JULY 1, 1969	128:00 - 129:00	6 / 27	3-94

**CSM  
CMP**

V66 - TRANS CSM STATE VECTOR  
TO LM SLOT

RETRIEVE SRC's FROM LM AND  
STOW IN B5 AND B6

RETRIEVE BAGGED ITEMS FROM LM  
AND STOW:

- CSC - A5
- CLOSEUP MAGAZINE - A5
- 70mm MAGAZINES - R13
- HELMETS - FOOD CONTAINERS

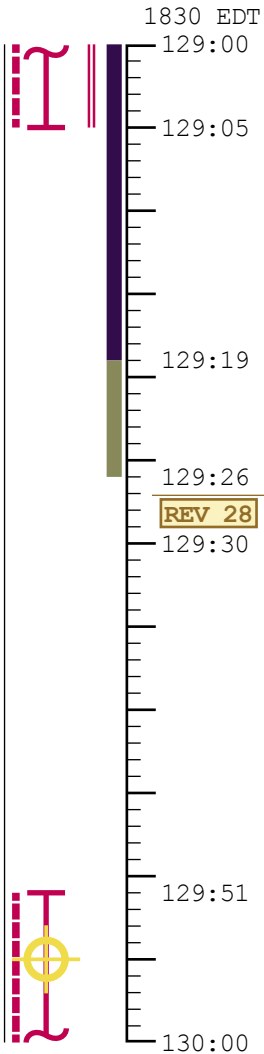

# FLIGHT PLAN

**CDR**

VACUUM BRUSH FWD  
DUMP VALVE FILTER

VACUUM SRC's

VACUUM:

CSC

70mm MAGAZINE

CLOSEUP MAGAZINE

HELMETS

GLOVES

VACUUM BRUSH LMP's PGA

VACUUM THE BRUSH  
AND STOW IN ISA

**LM**

**LMP**

UNSTOW AND HOLD SRC's  
FOR CLEANING

BAG SRC's AND TRANSFER TO CM

HOLD EQUIPMENT FOR CLEANING

BAG ITEMS AND TRANSFER TO CSM  
(GLOVES IN HELMETS)

VACUUM BRUSH CDR's PGA

**MCC-H**

UPLINK

CSM STATE VECTOR

MISSION	EDITION	DATE	TIME	DAY / REV	PAGE
APOLLO 11	FINAL	JULY 1, 1969	129:00 - 130:00	6 / 27-28	3-95

**CSM  
CMP**

REMOVE ISA CONTENTS AND  
STOW. PLACE CM JETTISONABLE  
ITEMS INTO ISA AND  
TRANSFER ISA TO LM.

UNSTOW AND INSTALL CSM HATCH

HATCH INTEGRITY CHECK  
DEPRESSURIZE TUNNEL

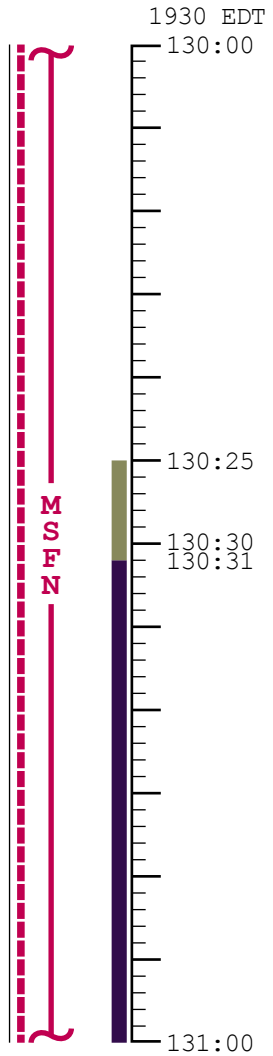

# FLIGHT PLAN

**CDR**

DISCONNECT FROM LM AND  
TRANSFER TO CM WITH ISA

**LM**

**LMP**

RETRIEVE ISA AND INSTALL ON  
PANELS 1 & 2

CONFIGURE LM SYSTEMS  
FOR JETTISON

DISCONNECT FROM LM HOSES  
CLOSE LM HATCH

IVT TO CSM

**MCC-H**

MISSION	EDITION	DATE	TIME	DAY / REV	PAGE
APOLLO 11	FINAL	JULY 1, 1969	130:00 - 131:00	6 / 28	3-96

MCC-H

# FLIGHT PLAN

NOTES

2030 EDT

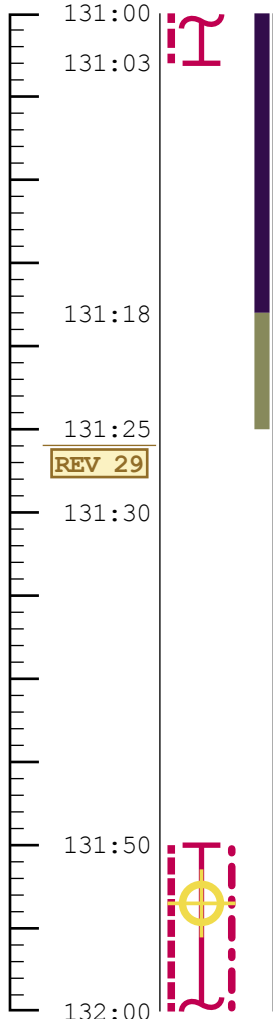

EQUIPMENT STOWAGE

VACUUM PGA's

SET UP CAMERA FOR LM JETTISON  
 16mm/18/CEX-BRKT, MIR  
 (f8, 250, 7) 12 fps

SM RCS CHECK  
 ENABLE JETS B-3 AND C-4  
 CONFIGURE DAP - R1=11102, R2=11111

GO/NO-GO FOR PYRO ARM  
 PYRO LOGIC ARM  
 THRUST MONITOR - P47

START CAMERA  
 LM JETTISON  
 SM RCS CHECK

GETI = 131:53:05  
 BT = 3.1 SEC  
 $\Delta V = 1$  FPS  
 RETROGRADE  
 ORBIT: 58.5 x 59.4

DAP CONFIGURATION  
 FOR LM JETTISON  
 CSM, 0.5° DB, 0.5°/SEC  
 A/C ROLL, 4 JET

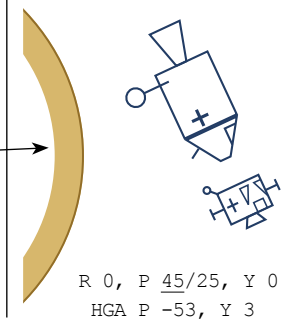

GO/NO-GO

MISSION	EDITION	DATE	TIME	DAY / REV	PAGE
APOLLO 11	FINAL	JULY 1, 1969	131:00 - 132:00	5 / 29	3-97

MCC-H

2130 EDT

# FLIGHT PLAN

NOTES

UPDATE

TEI<sub>30</sub> MNVR PAD

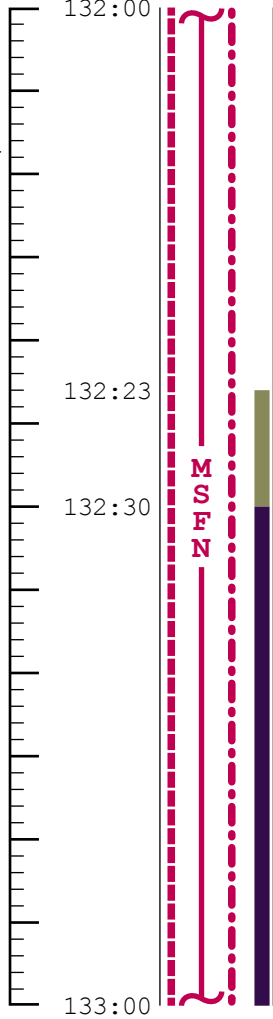

MNVR TO TEI BURN ATTITUDE

V66 - TRANS CSM STATE VECTOR TO LM SLOT  
BURN STATUS REPORT  
RECORD PRELIMINARY TEI<sub>30</sub> MNVR PAD

GO INERTIAL

DOFF AND BAG PGA's, HELMETS AND GLOVES

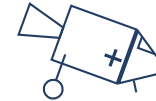
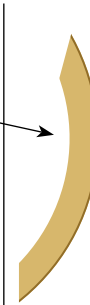
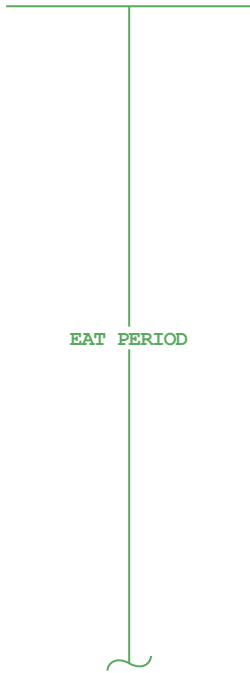

R 1.1, P 93.2/52.6, Y 13.8  
HGA P -79, Y 10

MISSION	EDITION	DATE	TIME	DAY / REV	PAGE
APOLLO 11	FINAL	JULY 1, 1969	132:00 - 133:00	6 / 29	3-98

MCC-H

# FLIGHT PLAN

NOTES

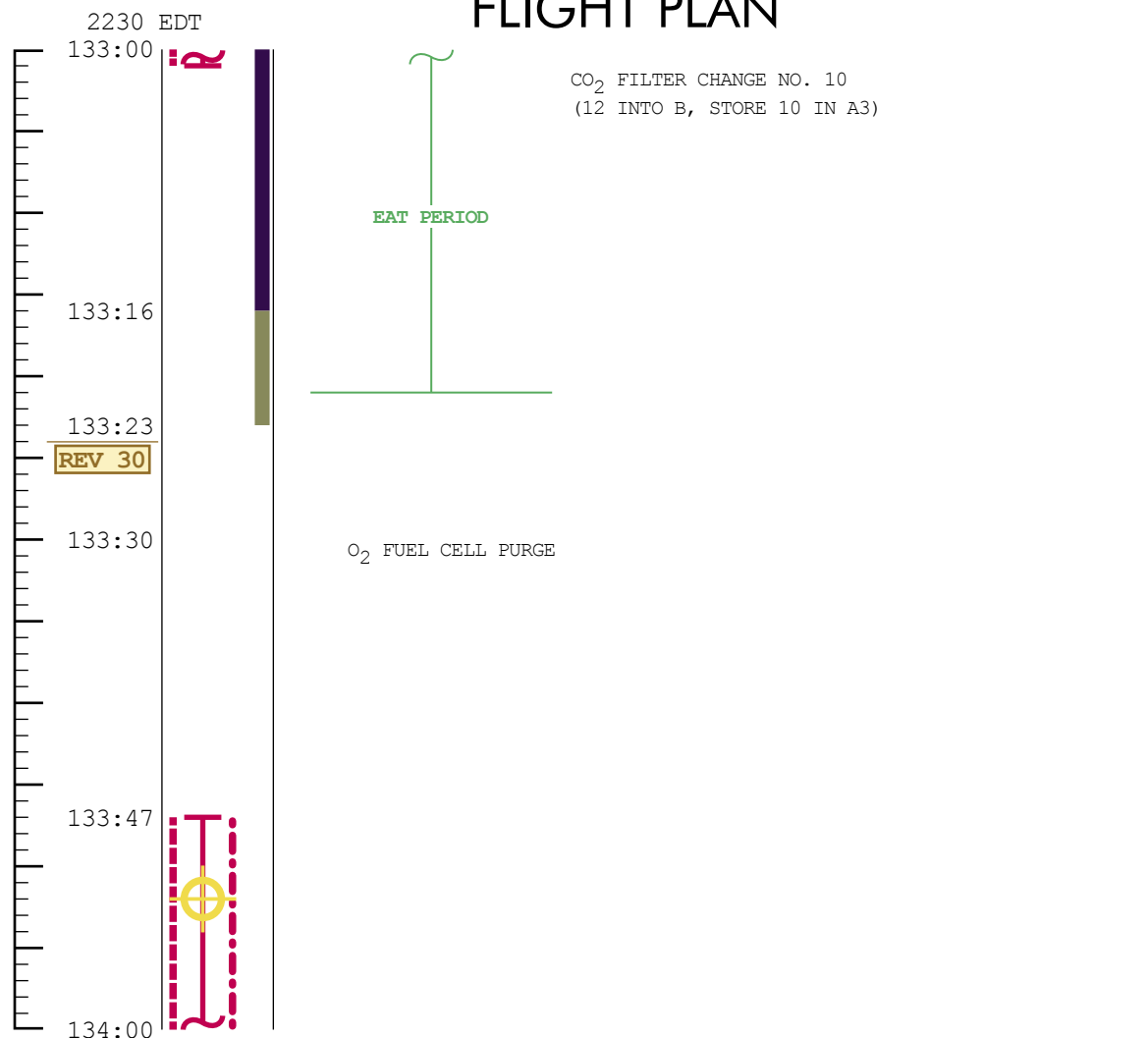

MISSION	EDITION	DATE	TIME	DAY / REV	PAGE
APOLLO 11	FINAL	JULY 1, 1969	133:00 - 134:00	6 / 30	3-99

MCC-H

# FLIGHT PLAN

NOTES

2330 EDT

134:00

PRI TEI SYSTEMS CKS:  
 C&W CK  
 CM RCS MON CK  
 SM RCS MON CK  
 EPS MONITOR CK  
 ECS REDUNDANT COMPONENTS CK

134:22

UPDATE

TEI<sub>30</sub> MNVR PAD  
 BLOCK DATA  
 (TEI<sub>31</sub>)

RECORD FINAL TEI<sub>30</sub> MNVR PAD AND  
 BLOCK DATA  
 GO/NO-GO FOR TEI<sub>31</sub>  
 THIS REV

134:29

UPLINK CMC

CSM STATE VECTOR  
 TEI TGT LOAD

134:30

V66 - TRANS CSM STATE VECTOR TO LM SLOT

FINAL

IMU REALIGN - P52  
 OPTION 3 - REFSMMAT  
 AND DRIFT CHECK

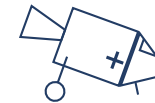

R 1.1, P 201.4/52.6, Y 13.8  
 HGA P -78, Y 5

134:58

P30 EXTERNAL ΔV

135:00

REPORT

P52 - (LIFT OFF REFSMMAT)

N71: \_ \_ / \_ \_

N05: \_ \_ . \_ \_

N93:

X \_ \_ . \_ \_

Y \_ \_ . \_ \_

Z \_ \_ . \_ \_

GET \_ \_ : \_ \_ : \_ \_

MISSION	EDITION	DATE	TIME	DAY / REV	PAGE
APOLLO 11	FINAL	JULY 1, 1969	134:00 - 135:00	6 / 30	3-100



THIS PAGE INTENTIONALLY LEFT BLANK.

TEI  
BURN CHART

	P OR Y RATES	ATT DEVIATION	SHUTDOWN TIME	RESIDUALS
TEI	10°/SEC TAKEOVER	±10° TAKEOVER	BT +2 SEC & $\Delta V_C = -40$ FPS	TRIM X AND Z AXIS TO 0.2 FPS

LOI <sub>1</sub> V <sub>GO</sub>	BT	TRAJECTORY	ABORT MODE
3292.7 - 1436.0	0 - 90	LUNAR ORBIT	MODE III - AFTER 1 REV
1436.0 - 1207.0	90 - 100	UNSTABLE	MODE II - 2 SPS BURNS FOR ORBIT STABILIZATION AND WATER OR CLA LANDING.
1207.0 - 0	100 - 149	UNSTABLE/ HYPERBOLIC	MODE I - 1 BURN AT TEI +2HRS P37 AT SPHERE OF INFLUENCE HYPERBOLIC ( $\Delta V$ 580 TO 0, BT 125-149)

**MCC-H**

0030 EDT

# FLIGHT PLAN

**NOTES**

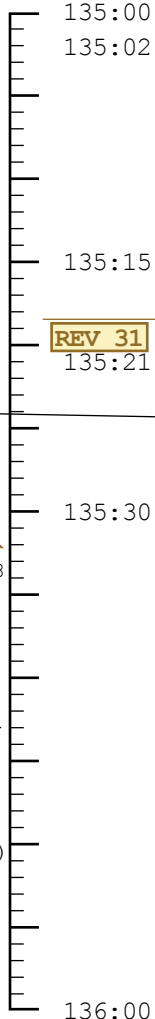

SPS THRUST - P40  
ROLL TO BURN ATT  
R 181.1, P 280.4/52.6, Y 13.8

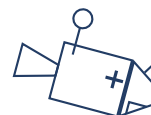

SXT STAR CK

EMS AV TEST

SM RCS CK

GDC ALIGN TO IMU

V48 - DAP UPDATE (S/C WT)

SM RCS MON CK

SPS MON CK

V66 - TRANS CSM STATE VECTOR TO LM SLOT

PITCH DOWN TO ACQ MSFN AND VISUALLY ACQ MOON

DAP CONFIGURATION FOR TEI  
CSM, 5° DB, 0.2°/SEC  
A/C ROLL, 4 JET  
DAP - R1=10111 R2=11111

GET: 135:24:34  
ULLAGE = 2 JET 16 SEC  
ΔV = 3292.7 FPS  
BT = 2 MIN 29 SEC

IMU REALIGN - P52  
OPTION 1 - PREFERRED  
AND STAR CK

**MSFN**

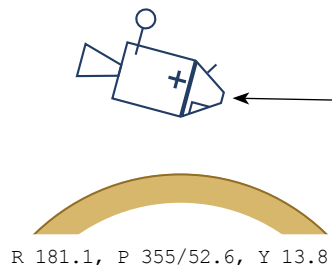

UPLINK

DESIRED ORIENTATION  
(PTC)

SET CAMERA FOR POST-TEI  
EL/80/CEX (f5.6, 250, INF)  
OR  
EL/80/BW (f4, 250, INF)

BURN STATUS REPORT				
X	X	<input type="checkbox"/>	:	ΔTIG
X	X		:	BT
<input type="checkbox"/>			.	V <sub>gx</sub>
TRIM				
X	X	X		R
X	X	X		P
X	X	X		Y
<input type="checkbox"/>			.	V <sub>gx</sub>
<input type="checkbox"/>			.	V <sub>gy</sub>
<input type="checkbox"/>			.	V <sub>gz</sub>
<input type="checkbox"/>			.	ΔV <sub>c</sub>
X	X	X		FUEL
X	X	X		OX
X	X	X		UNBAL

P52 - PULSE TORQUE  
TO PTC REFSMMAT  
PLATFORM ALIGN  
CHECKED WITH OPTICS

MISSION	EDITION	DATE	TIME	DAY / REV	PAGE
APOLLO 11	FINAL	JULY 1, 1969	135:00 - 136:00	6 / TEC	3-101

MCC-H

# FLIGHT PLAN

## NOTES

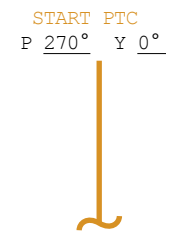
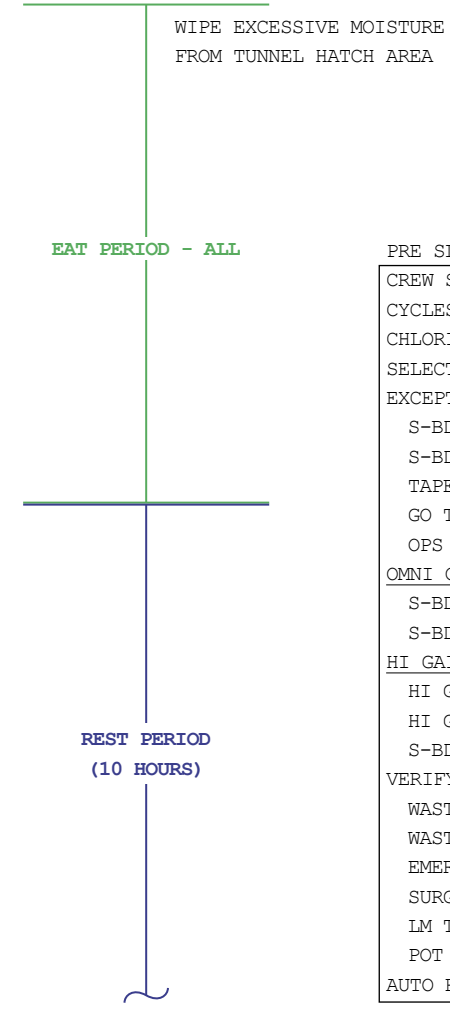
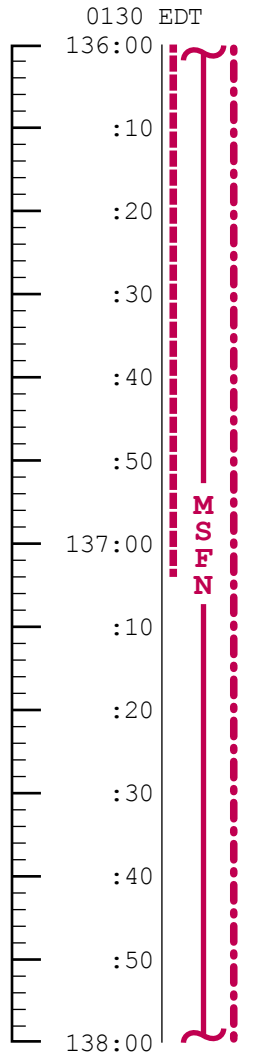

PTC ESTABLISHED IN G&N P, Y ±30° DB, R RATE OF 0.3°/SEC

- PRE SLEEP CHECKLIST
- CREW STATUS REPORT (RADIATION, MEDICATION)
  - CYCLES O<sub>2</sub> & H<sub>2</sub> FANS
  - CHLORINATE POTABLE WATER
  - SELECT NORMAL LUNAR CONFIGURATION
  - EXCEPT: (FOR COAST ASLEEP)
    - S-BD NORMAL MODE VOICE - OFF
    - S-BD AUX TAPE - OFF
    - TAPE RCDR FWD - OFF
    - GO TO HGA OR CONTINUE OMNI
    - OPS PER MSFN
  - OMNI OPS
    - S-BD ANT OMNI - OMNI
    - S-BD ANT OMNI - B
  - HI GAIN OPS
    - HI GAIN ANT BEAM - NARROW
    - HI GAIN ANT TRACK - REACQ
    - S-BD ANT - HI GAIN
  - VERIFY:
    - WASTE MNGT OVBD DRAIN - OFF
    - WASTE STOW VENT VLV - CLOSED
    - EMERG CABIN PRESS VLV - BOTH
    - SURGE TK O<sub>2</sub> VLV - OFF
    - LM TUNNEL VENT VLV - OFF
    - POT H<sub>2</sub>O HTR - OFF
    - AUTO RCS JET SELECT (16) - OFF

P23 - NO COMM, (5 SETS)  
 TEI +30 MIN (136:00)  
 MENKENT (30), LNH  
 MENKENT (30), LNH  
 ATRIA (34), LNH  
 NUNKI (37), LFH  
 NUNKI (37), LFH

ONBOARD READOUT

BAT C \_\_\_\_\_

PYRO BAT A \_\_\_\_\_

PYRO BAT B \_\_\_\_\_

RCS A \_\_\_\_\_

B \_\_\_\_\_

C \_\_\_\_\_

D \_\_\_\_\_

DC IND SEL TO MNA OR MNB

MISSION	EDITION	DATE	TIME	DAY / REV	PAGE
APOLLO 11	FINAL	JULY 1, 1969	136:00 - 138:00	6 / TEC	3-102

**MCC-H**

# FLIGHT PLAN

**NOTES**

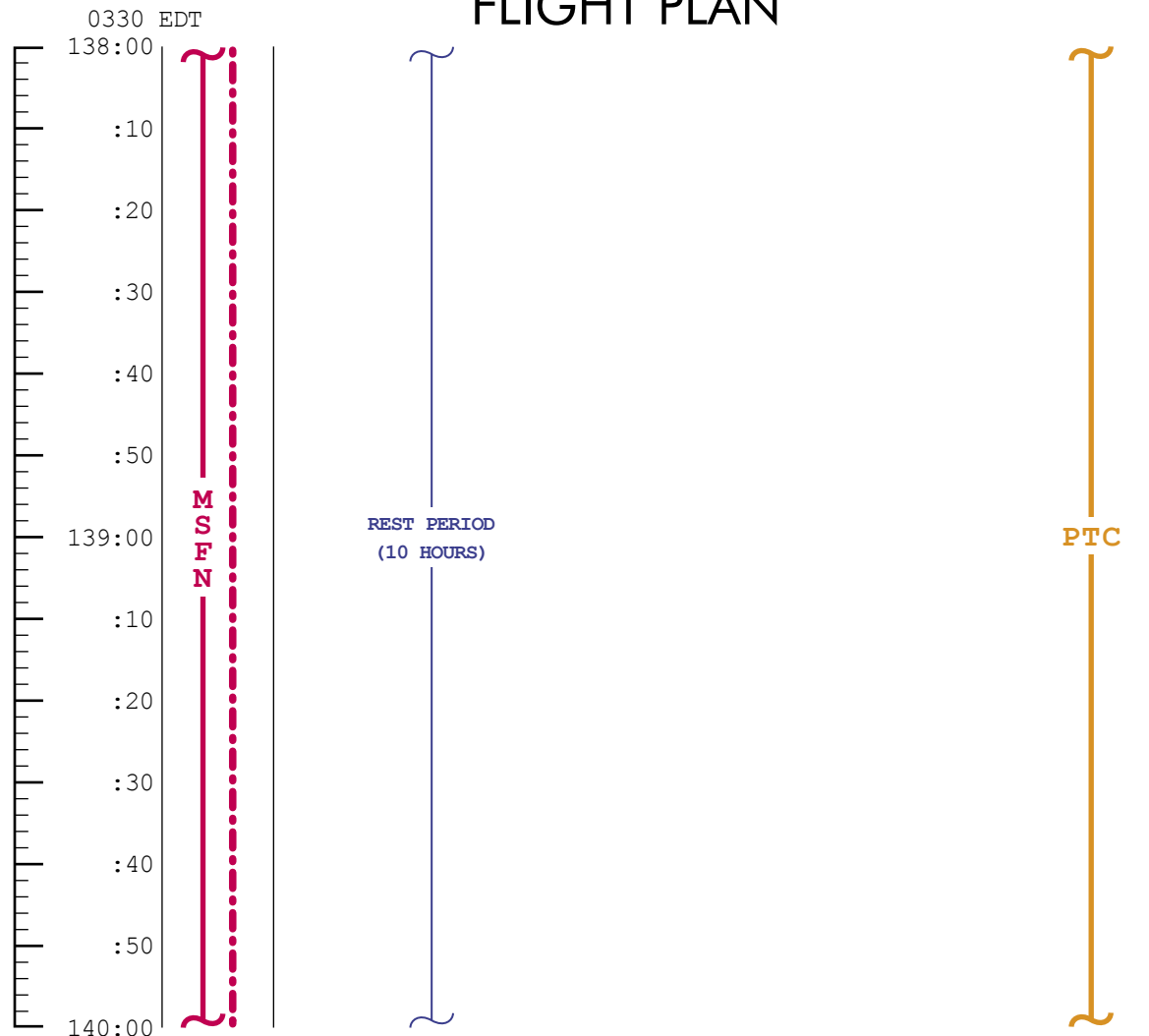

MISSION	EDITION	DATE	TIME	DAY / REV	PAGE
APOLLO 11	FINAL	JULY 1, 1969	138:00 - 140:00	6 / TEC	3-103

MCC-H

# FLIGHT PLAN

NOTES

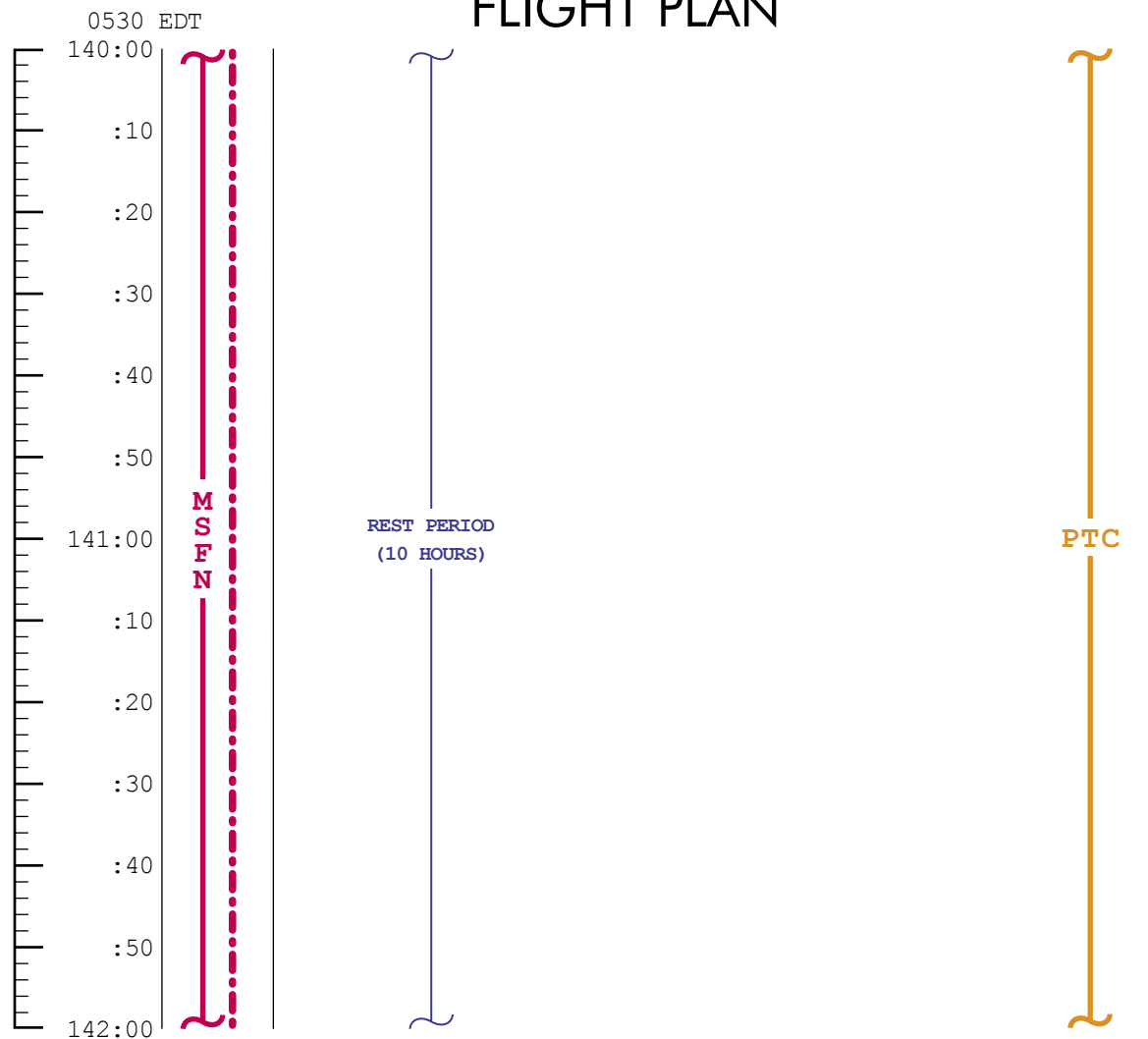

MISSION	EDITION	DATE	TIME	DAY / REV	PAGE
APOLLO 11	FINAL	JULY 1, 1969	140:00 - 142:00	6 / TEC	3-104

**MCC-H**

# FLIGHT PLAN

**NOTES**

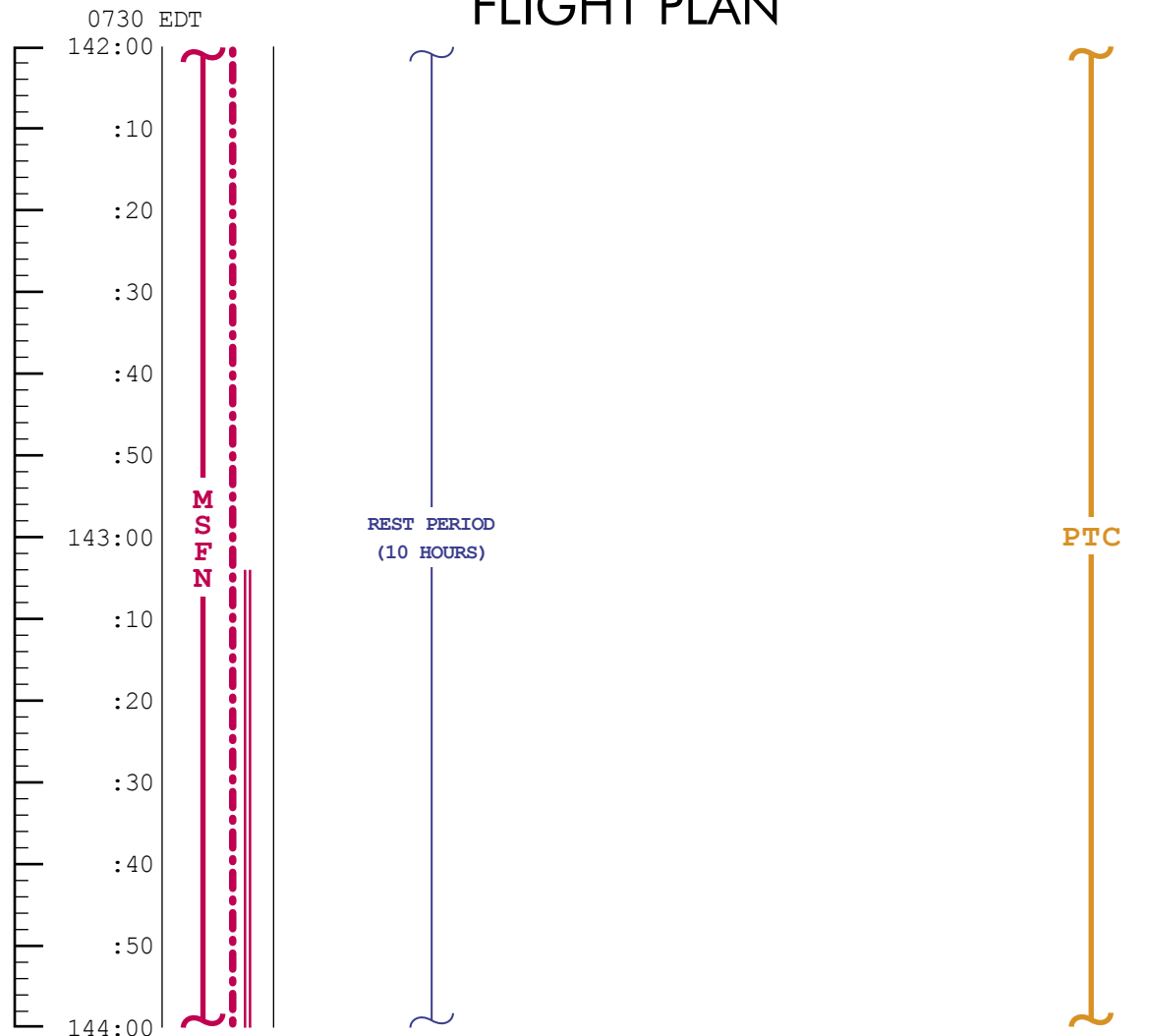

MISSION	EDITION	DATE	TIME	DAY / REV	PAGE
APOLLO 11	FINAL	JULY 1, 1969	142:00 - 144:00	6 / TEC	3-105

MCC-H

# FLIGHT PLAN

NOTES

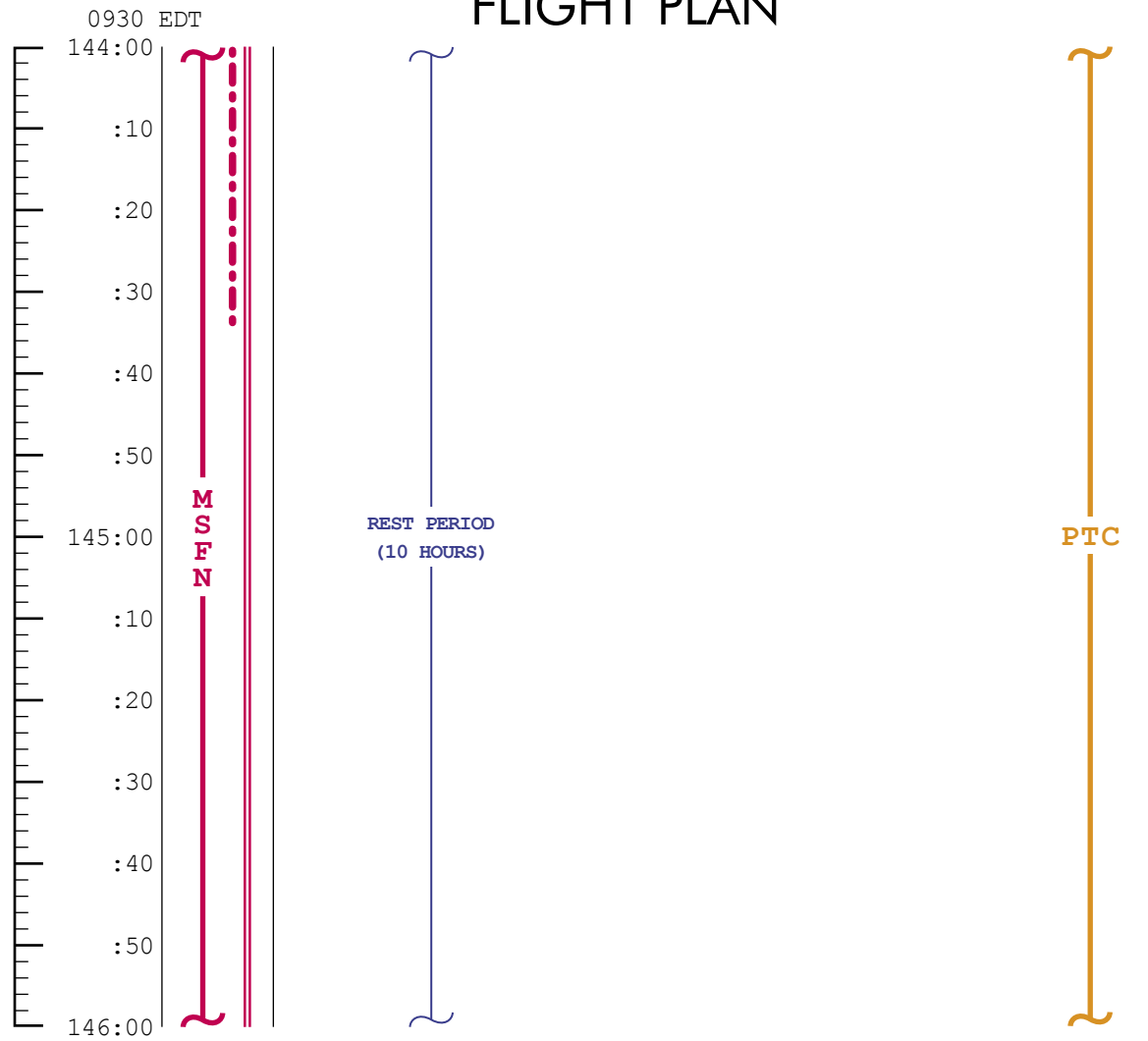

MISSION	EDITION	DATE	TIME	DAY / REV	PAGE
APOLLO 11	FINAL	JULY 1, 1969	144:00 - 146:00	6 / TEC	3-106



**MCC-H**

# FLIGHT PLAN

**NOTES**

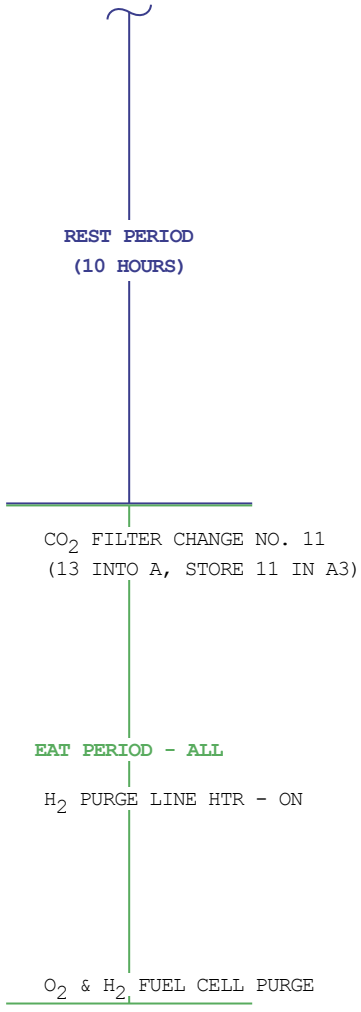
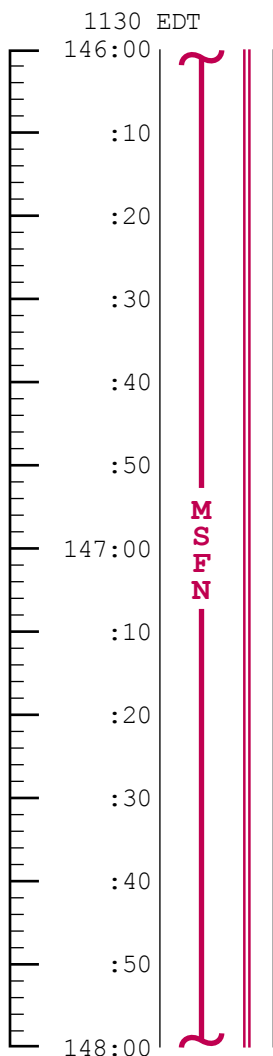

POST SLEEP CHECKLIST  
 CREW STATUS REPORT (SLEEP)  
 CYCLE O<sub>2</sub> & H<sub>2</sub> FANS  
 GDC ALIGN TO IMU  
 CONSUMABLES UPDATE  
 SELECT NORMAL LUNAR CONFIGURATION  
 EXCEPT:  
 S-BD AUX TAPE - OFF  
 TAPE RCDR FWD - OFF  
 POT H<sub>2</sub>O HTR - ON

P23 - NO COMM, (5 SETS)  
 TEI +11:30 (147:00)  
 SPICA (26), LNH  
 SPICA (26), LNH  
 MENKENT (30), LNH  
 NUNKI (37), LFH  
 NUNKI (37), LFH

CONSUMABLE UPDATE  
 (Δ FROM NOMINAL)  
 GET: \_\_\_\_\_  
 RCS TOT \_\_\_\_\_  
     A \_\_\_\_\_  
     B \_\_\_\_\_  
     C \_\_\_\_\_  
     D \_\_\_\_\_  
 H<sub>2</sub> TOT \_\_\_\_\_  
 O<sub>2</sub> TOT \_\_\_\_\_

PHOTO AS CONVENIENT

EARTH:  
 EL/250/CEX-RING  
 (11, 250, INF)

MOON:  
 EL/250/BW-RING  
 (5.6, 250, INF)

MISSION	EDITION	DATE	TIME	DAY / REV	PAGE
APOLLO 11	FINAL	JULY 1, 1969	146:00 - 148:00	7 / TEC	3-107

**MCC-H**

# FLIGHT PLAN

**NOTES**

1330 EDT  
 148:00  
 :10  
 :20  
 :30  
 :40  
 :50  
 149:00  
 :10  
 :20  
 :30  
 :40  
 :50  
 150:00

UPLINK  
 CSM STATE VECTOR  
 MCC5 TGT LOAD

UPDATE  
 MCC5 MNVR PAD

**M  
S  
F  
N**

WIPE EXCESSIVE MOISTURE FROM TUNNEL HATCH AREA

V66 - TRANS CSM STATE VECTOR TO LM SLOT

RECORD MCC5 MNVR PAD

IMU REALIGN - P52
OPTION 3 - REFSMMAT

EXT ΔV - P30

SPS/RCS THRUST - P40/41

**PTC**

P23 - NO COMM, (5 SETS)  
 TEI +13:00 (148:30)  
 ALPHERATZ (01), EFH  
 DIPHDA (02), EFH  
 MIRFAK (10), ENH  
 MIRFAK (10), ENH  
 ALDEBARAN (11), ENH

P52 - (PTC REFSMMAT)  
 N71: \_ \_ \_ , \_ \_ \_  
 N05: \_ \_ \_ . \_ \_ \_  
 N93:  
 X \_ \_ \_ . \_ \_ \_  
 Y \_ \_ \_ . \_ \_ \_  
 Z \_ \_ \_ . \_ \_ \_  
 GET \_ \_ \_ : \_ \_ \_ : \_ \_ \_

MISSION	EDITION	DATE	TIME	DAY / REV	PAGE
APOLLO 11	FINAL	JULY 1, 1969	148:00 - 150:00	7 / TEC	3-108

THIS PAGE INTENTIONALLY LEFT BLANK.

MCC  
BURN CHART

	P OR Y RATES	ATT DEVIATION	SHUTDOWN TIME	RESIDUALS
MCC5	10°/SEC TAKEOVER	10° TAKEOVER	BT +1 SEC	TRIM X AXIS ONLY

MCC-H

# FLIGHT PLAN

NOTES

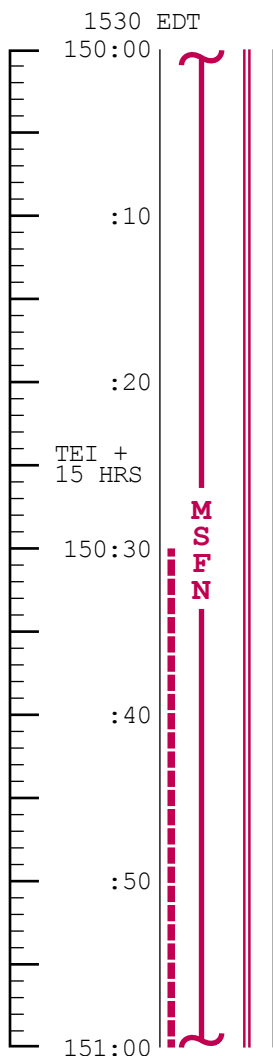

MNVR TO BURN ATT

SXT STAR CK

EMS ΔV TEST

SM RCS MON CK

GDC ALIGN TO IMU

MCC5 ΔV=NOMINALLY ZERO

SM RCS MON CK

SPS MON CK

V66 - TRANS CSM STATE VECTOR TO LM SLOT

BURN STATUS REPORT

BATTERY CHARGE, BATTERY A

PTC ESTABLISHED IN G&N P,  
Y ±30° DB, R RATE OF 0.3°/SEC

START PTC  
P 270° Y 0°

BURN STATUS REPORT				
X	X	<input type="checkbox"/>	•	ATIG
X	X		•	BT
<input type="checkbox"/>			•	V <sub>gx</sub>
		TRIM		
X	X	X		R
X	X	X		P
X	X	X		Y
<input type="checkbox"/>			•	V <sub>gx</sub>
<input type="checkbox"/>			•	V <sub>gy</sub>
<input type="checkbox"/>			•	V <sub>gz</sub>
<input type="checkbox"/>			•	ΔV <sub>C</sub>
X	X	X		FUEL
X	X	X		OX
X	X	X		UNBAL

MISSION	EDITION	DATE	TIME	DAY / REV	PAGE
APOLLO 11	FINAL	JULY 1, 1969	150:00 - 151:00	7 / TEC	3-109

**MCC-H**

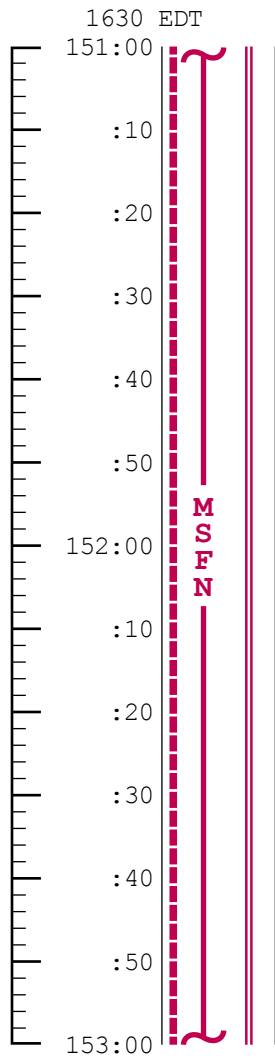

# FLIGHT PLAN

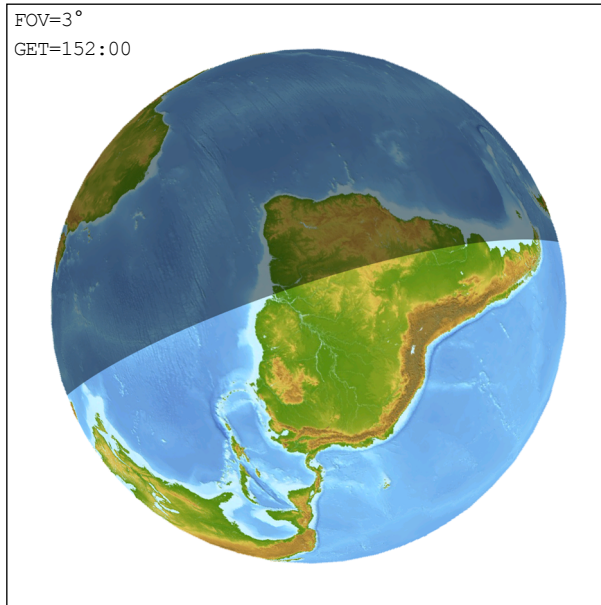

**NOTES**

**PTC**

P23 - NO COMM, (5 SETS)  
 TEI +15:30 (152:00)  
 DIPHDA (02), EFH  
 DIPHDA (02), EFH  
 NAVI (03), ENH  
 MIRFAK (10), ENH  
 ALDEBARAN (11), ENH

MISSION	EDITION	DATE	TIME	DAY / REV	PAGE
APOLLO 11	FINAL	JULY 1, 1969	151:00 - 153:00	7 / TEC	3-110

**MCC-H**

# FLIGHT PLAN

**NOTES**

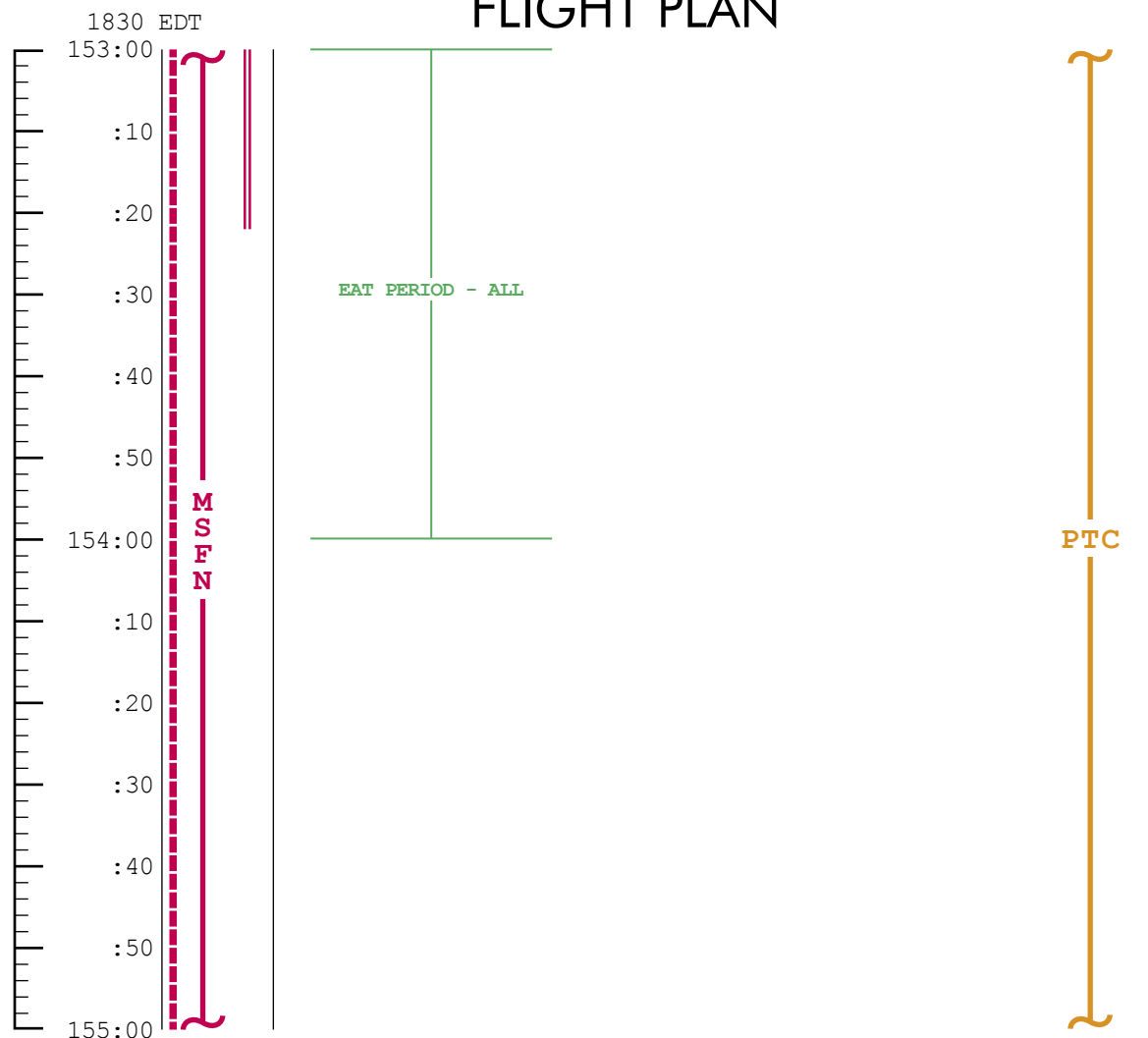

P23 - NO COMM, (3 SETS)  
TEI +19:00 (154:30)  
SPICA (26), ENH  
ANTARES (33), EFH  
NUNKI (37), EFH

MISSION	EDITION	DATE	TIME	DAY / REV	PAGE
APOLLO 11	FINAL	JULY 1, 1969	153:00 - 155:00	7 / TEC	3-111

**MCC-H**

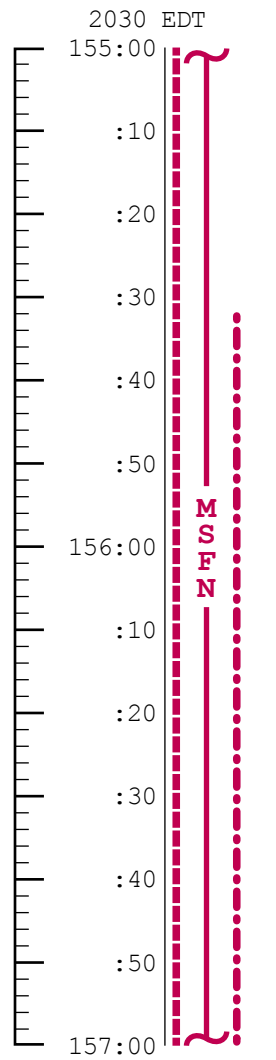

# FLIGHT PLAN

**NOTES**



MISSION	EDITION	DATE	TIME	DAY / REV	PAGE
APOLLO 11	FINAL	JULY 1, 1969	155:00 - 157:00	7 / TEC	3-112



MCC-H

# FLIGHT PLAN

NOTES

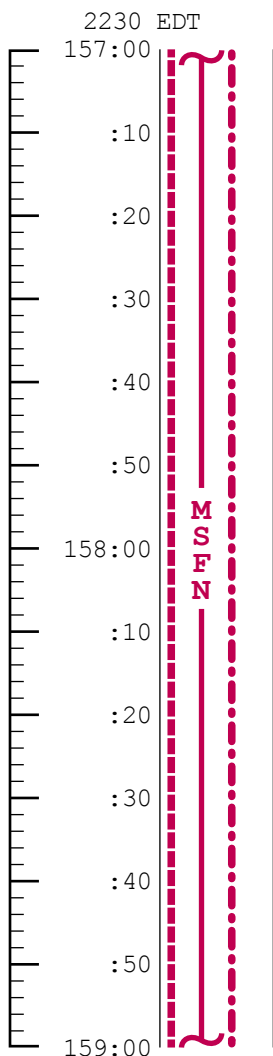

WIPE EXCESSIVE MOISTURE FROM TUNNEL HATCH AREA

O<sub>2</sub> FUEL CELL PURGE

CO<sub>2</sub> FILTER CHANGE NO. 12  
(14 INTO B, STORE 12 IN A3)

P23 - NO COMM, (5 SETS)
TEI +22:30 (158:00)
DIPHDA (02), EFH
DIPHDA (02), EFH
MENKAR (07), ENH
MIRFAK (10), ENH
ALDEBARAN (11), ENH

MISSION	EDITION	DATE	TIME	DAY / REV	PAGE
APOLLO 11	FINAL	JULY 1, 1969	157:00 - 159:00	7 / TEC	3-113

MCC-H

# FLIGHT PLAN

NOTES

0030 EDT

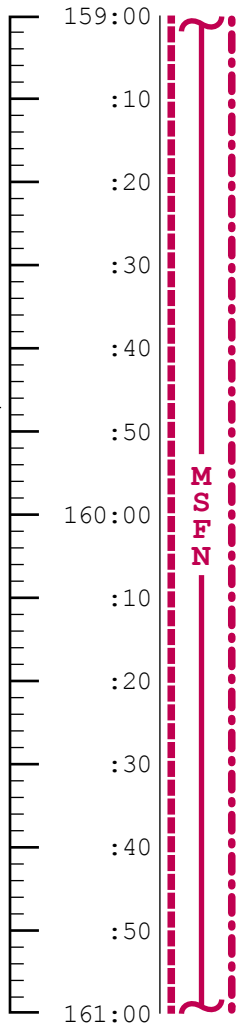

UPDATE

PRELIMINARY MCC6  
MNVR PAD & ENTRY PAD  
(ASSUMES MCC6)

EAT PERIOD - ALL

EMS CK  
RECORD MCC6 &  
PRELIMINARY ENTRY PADS

REST PERIOD  
(10 HOURS)

PRE SLEEP CHECKLIST

CREW STATUS REPORT (RADIATION, MEDICATION)  
CYCLES O<sub>2</sub> & H<sub>2</sub> FANS  
CHLORINATE POTABLE WATER  
SELECT NORMAL LUNAR CONFIGURATION  
EXCEPT: (FOR COAST ASLEEP)  
S-BD NORMAL MODE VOICE - OFF  
S-BD AUX TAPE - OFF  
TAPE RCDR FWD - OFF  
GO TO HGA OR CONTINUE OMNI  
OPS PER MSFN  
OMNI OPS  
S-BD ANT OMNI - OMNI  
S-BD ANT OMNI - B  
HI GAIN OPS  
HI GAIN ANT BEAM - NARROW  
HI GAIN ANT TRACK - REACQ  
S-BD ANT - HI GAIN  
VERIFY:  
WASTE MNGT OVBD DRAIN - OFF  
WASTE STOW VENT VLV - CLOSED  
EMERG CABIN PRESS VLV - BOTH  
SURGE TK O<sub>2</sub> VLV - OFF  
REPRESS PACK O<sub>2</sub> VLV - OFF  
LM TUNNEL VENT VLV - OFF  
POT H<sub>2</sub>O HTR - OFF  
AUTO RCS JET SELECT (16) - OFF

ONBOARD READOUT

BAT C \_\_\_\_\_  
PYRO BAT A \_\_\_\_\_  
PYRO BAT B \_\_\_\_\_  
RCS A \_\_\_\_\_  
B \_\_\_\_\_  
C \_\_\_\_\_  
D \_\_\_\_\_  
DC IND SEL TO MNA OR MNB

MISSION	EDITION	DATE	TIME	DAY / REV	PAGE
APOLLO 11	FINAL	JULY 1, 1969	159:00 - 161:00	7 / TEC	3-114

**MCC-H**

# FLIGHT PLAN

**NOTES**

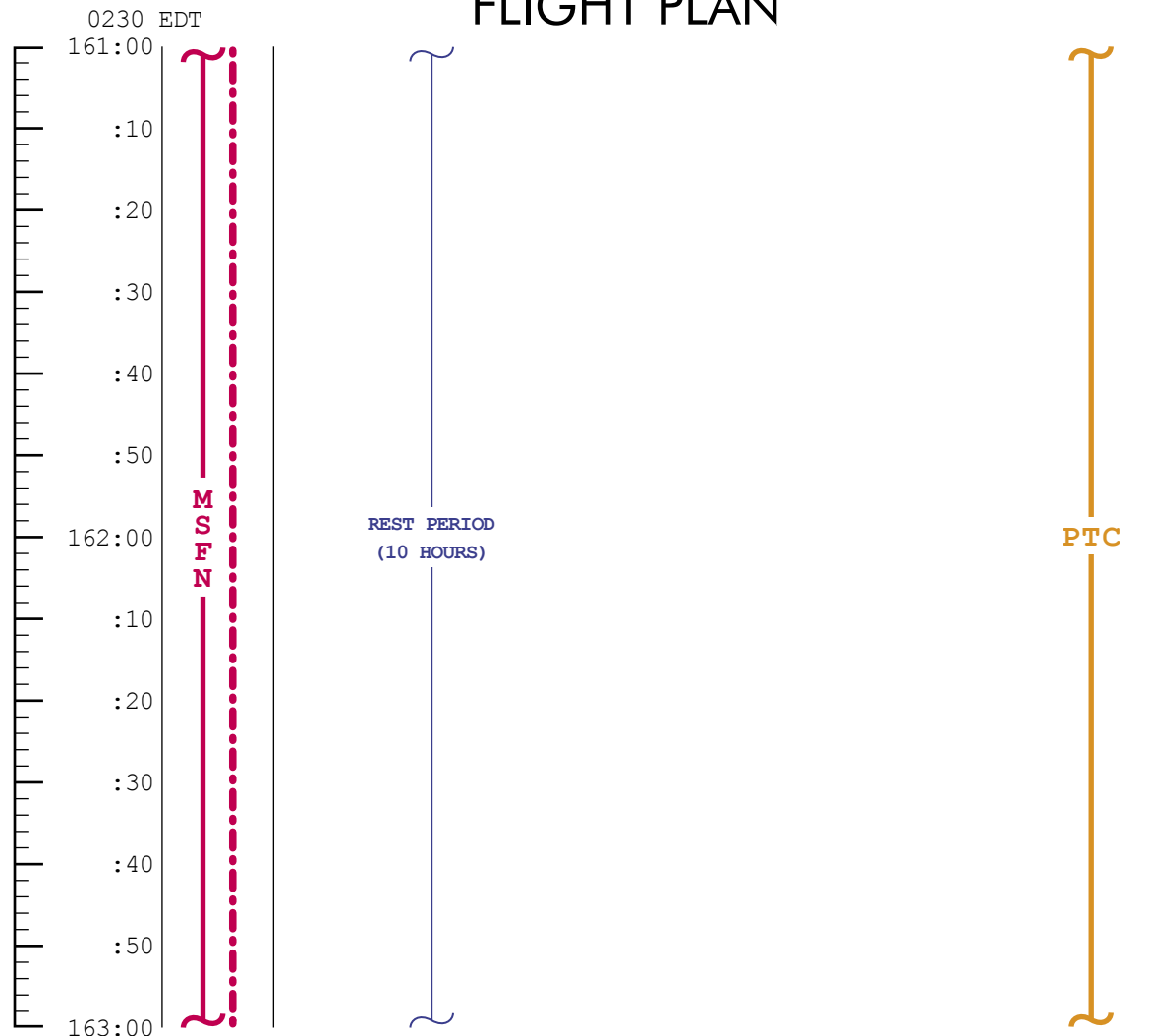

MISSION	EDITION	DATE	TIME	DAY / REV	PAGE
APOLLO 11	FINAL	JULY 1, 1969	161:00 - 163:00	7 / TEC	3-115

MCC-H

# FLIGHT PLAN

NOTES

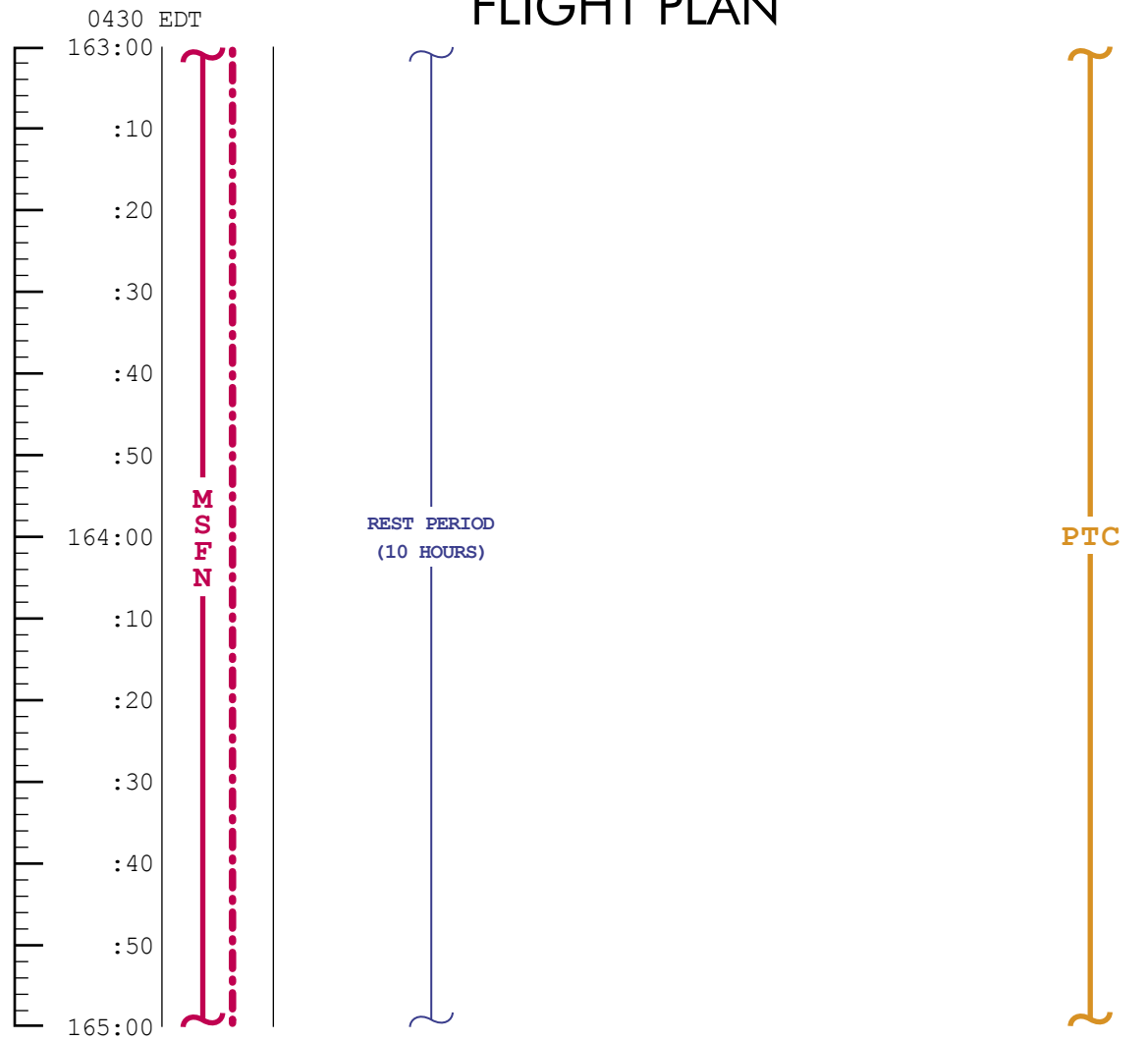

MISSION	EDITION	DATE	TIME	DAY / REV	PAGE
APOLLO 11	FINAL	JULY 1, 1969	163:00 - 165:00	7 / TEC	3-116

**MCC-H**

# FLIGHT PLAN

**NOTES**

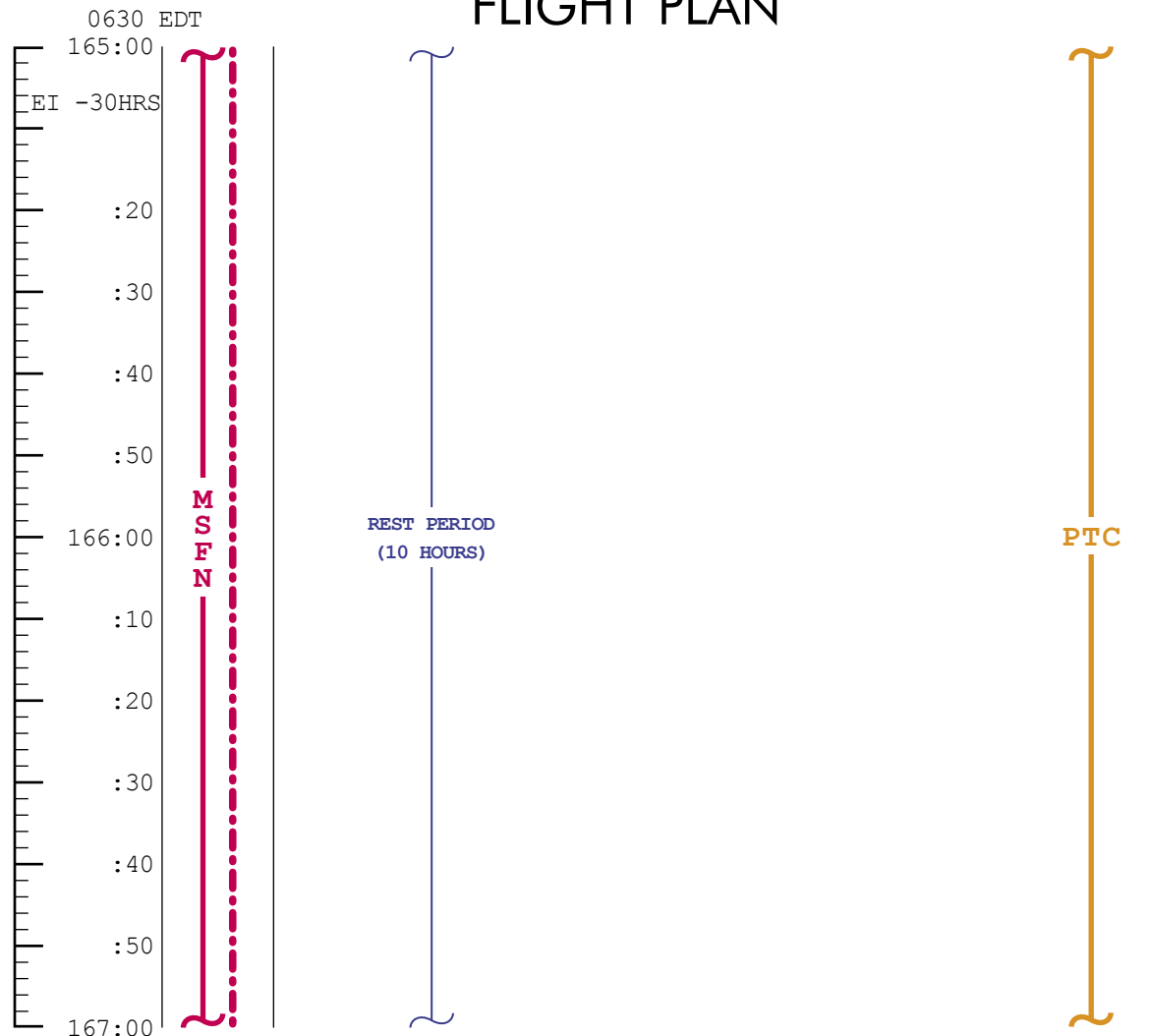

MISSION	EDITION	DATE	TIME	DAY / REV	PAGE
APOLLO 11	FINAL	JULY 1, 1969	165:00 - 167:00	7 / TEC	3-117

**MCC-H**

# FLIGHT PLAN

**NOTES**

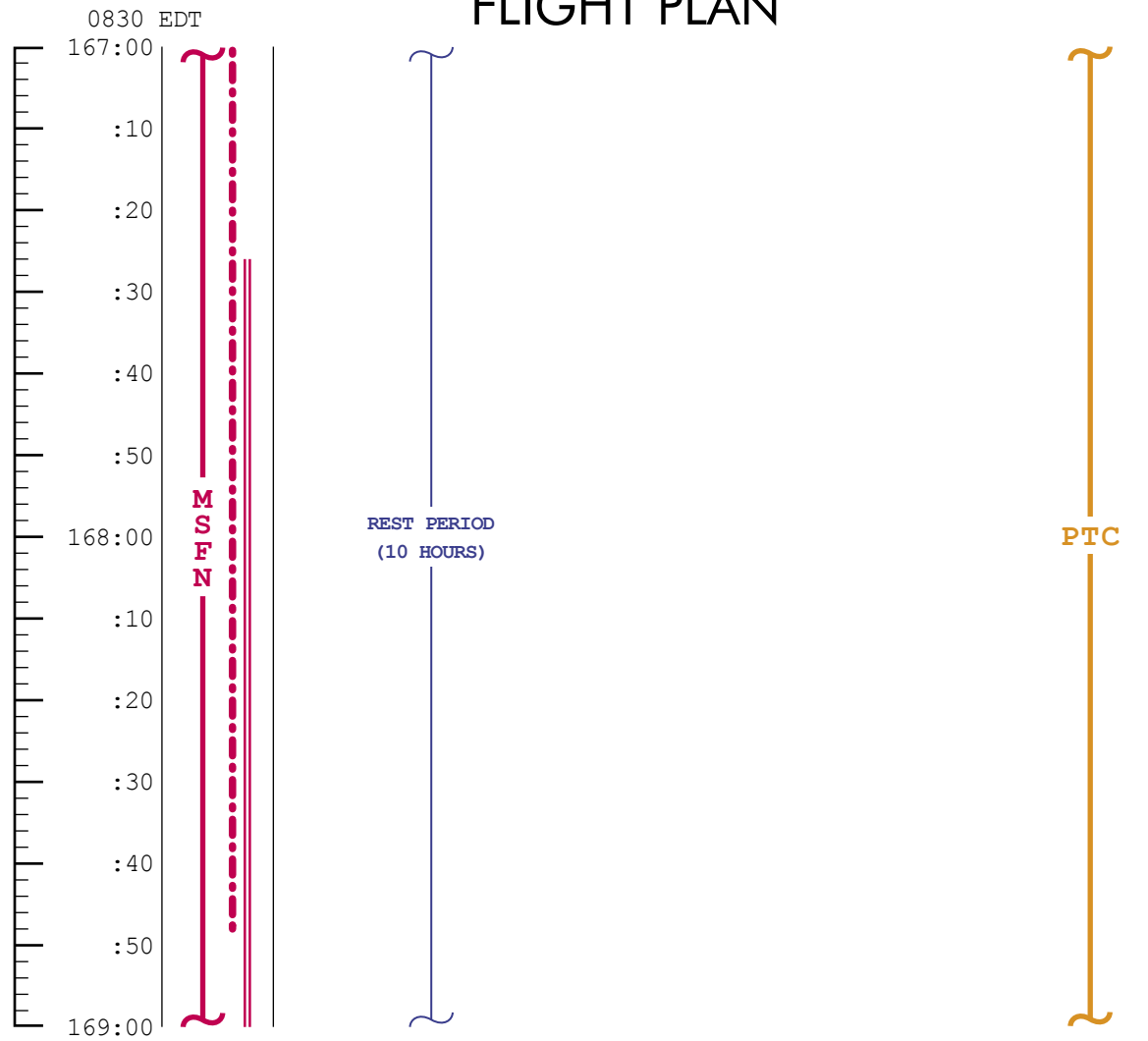

MISSION	EDITION	DATE	TIME	DAY / REV	PAGE
APOLLO 11	FINAL	JULY 1, 1969	167:00 - 169:00	7 / TEC	3-118

MCC-H

# FLIGHT PLAN

NOTES

1030 EDT

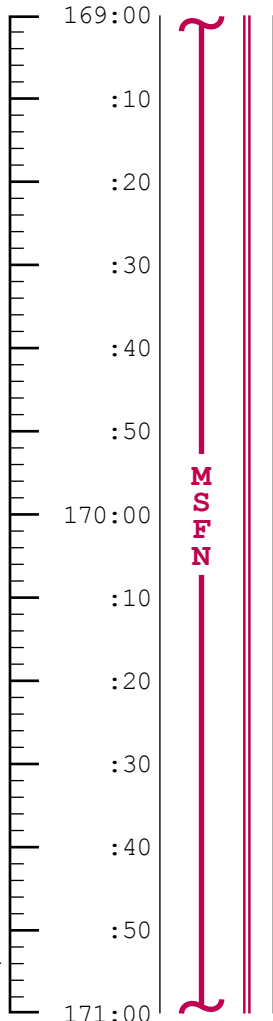

M  
S  
F  
N

REST PERIOD  
(10 HOURS)

CO<sub>2</sub> FILTER CHANGE NO. 13  
(15 INTO A, STORE 13 IN A4)

REPORT CM RCS EJECTOR VLV TEMP

EAT PERIOD - ALL

O<sub>2</sub> FUEL CELL PURGE  
V66 - TRANSFER CSM STATE VECTOR TO LM SLOT

POST SLEEP CHECKLIST

CREW STATUS REPORT (SLEEP)  
CYCLE O<sub>2</sub> & H<sub>2</sub> FANS  
GDC ALIGN TO IMU  
CONSUMABLES UPDATE  
SELECT NORMAL LUNAR CONFIGURATION  
EXCEPT:  
S-BD AUX TAPE - OFF  
TAPE RCDR FWD - OFF  
POT H<sub>2</sub>O HTR - ON  
AUTO RCS JET SELECT (16) - ON

P23 - NO COMM, (5 SETS)  
TEI +35:00 (170:30)  
DIPHDA (02), EFH  
DIPHDA (02), EFH  
NAVI (03), ENH  
MIRFAK (10), ENH  
ALDEBARAN (11), ENH

CONSUMABLE UPDATE  
(Δ FROM NOMINAL)  
GET: \_\_\_\_\_  
RCS TOT \_\_\_\_\_  
A \_\_\_\_\_  
B \_\_\_\_\_  
C \_\_\_\_\_  
D \_\_\_\_\_  
H<sub>2</sub> TOT \_\_\_\_\_  
O<sub>2</sub> TOT \_\_\_\_\_

PTC

UPLINK CMC  
CSM STATE VECTOR  
MCC6 TGT LOAD

MISSION	EDITION	DATE	TIME	DAY / REV	PAGE
APOLLO 11	FINAL	JULY 1, 1969	169:00 - 171:00	8 / TEC	3-119

MCC  
BURN CHART

	P OR Y RATES	ATT DEVIATION	SHUTDOWN TIME	RESIDUALS
MCC6	10°/SEC TAKEOVER	10° TAKEOVER	BT +1 SEC	TRIM X AXIS ONLY



**MCC-H**

UPDATE  
 MCC6 PAD DATA  
 ENTRY PAD  
 (ASSUMES MCC6)

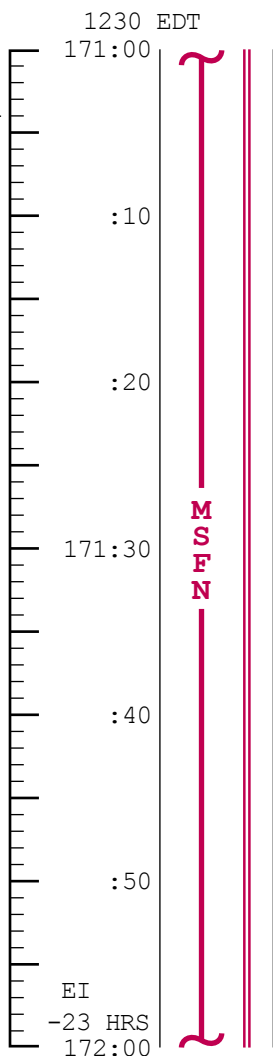

# FLIGHT PLAN

WIPE EXCESSIVE MOISTURE FROM TUNNEL HATCH AREA

RECORD MCC6 AND PRELIMINARY ENTRY PAD DATA

IMU REALIGN - P52  
 (OPTION 3 - REFSMMAT)

P52 - (PTC REFSMMAT)  
 N71: \_ \_ \_ , \_ \_ \_  
 N05: \_ \_ \_ . \_ \_ \_  
 N93:  
 X \_ \_ . \_ \_ \_  
 Y \_ \_ . \_ \_ \_  
 Z \_ \_ . \_ \_ \_  
 GET \_ \_ \_ : \_ \_ : \_ \_ \_

EXT ΔV - P30

SPS/RCS THRUST - P40/41

MNVR TO BURN ATT

SXT STAR CK

EMS ΔV TEST

SM RCS MON CK

GDC ALIGN TO IMU

MCC6 ΔV=NOMINALLY ZERO



**NOTES**

BURN STATUS REPORT		
X X <input type="checkbox"/>	•	ΔTIG
X X <input type="checkbox"/>	•	BT
<input type="checkbox"/>	•	V <sub>gx</sub>
TRIM		
X X X		R
X X X		P
X X X		Y
<input type="checkbox"/>	•	V <sub>gx</sub>
<input type="checkbox"/>	•	V <sub>gy</sub>
<input type="checkbox"/>	•	V <sub>gz</sub>
<input type="checkbox"/>	•	ΔV <sub>C</sub>
X X X		FUEL
X X X		OX
X X X		UNBAL

MISSION	EDITION	DATE	TIME	DAY / REV	PAGE
APOLLO 11	FINAL	JULY 1, 1969	171:00 - 172:00	8 / TEC	3-120

MCC-H

# FLIGHT PLAN

NOTES

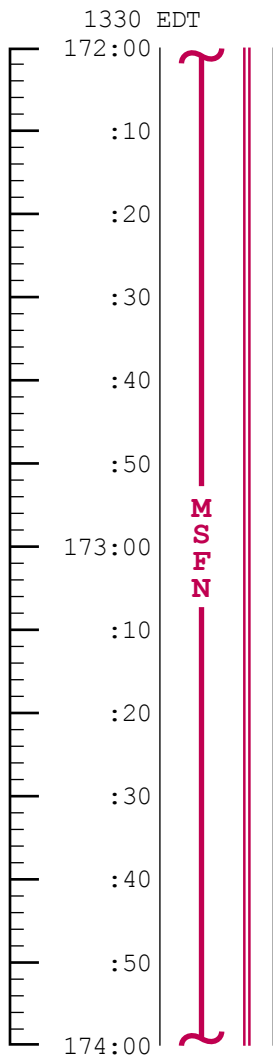

SM RCS MON CK  
 SPS MON CK  
 V66 - TRANS CSM STATE VECTOR TO LM SLOT  
 BURN STATUS REPORT  
 BATTERY CHARGE, BATTERY B

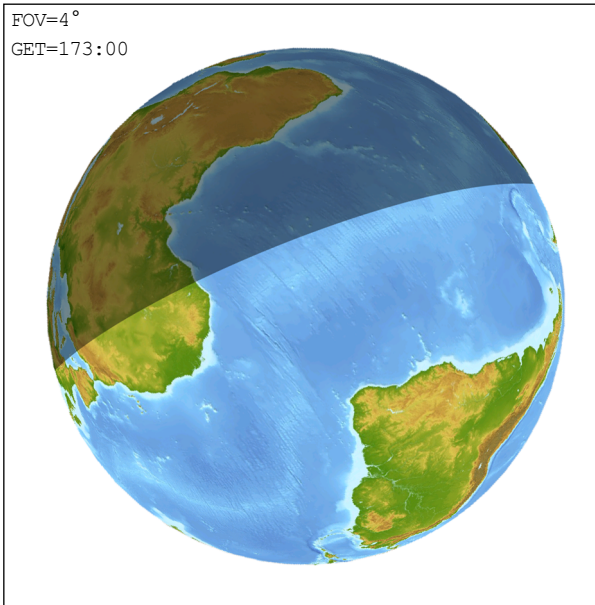

START PTC  
 P 270° Y 0°

PTC ESTABLISHED IN G&N P,  
 Y ±30° DB, R RATE OF 0.3°/SEC

P23 - NO COMM, (3 SETS)  
 TEI +37:00 (172:30)  
 SPICA (26), LNH  
 ANTARES (33), LFH  
 NUNKI (37), LFH

MISSION	EDITION	DATE	TIME	DAY / REV	PAGE
APOLLO 11	FINAL	JULY 1, 1969	172:00 - 174:00	8 / TEC	3-121

**MCC-H**

# FLIGHT PLAN

**NOTES**

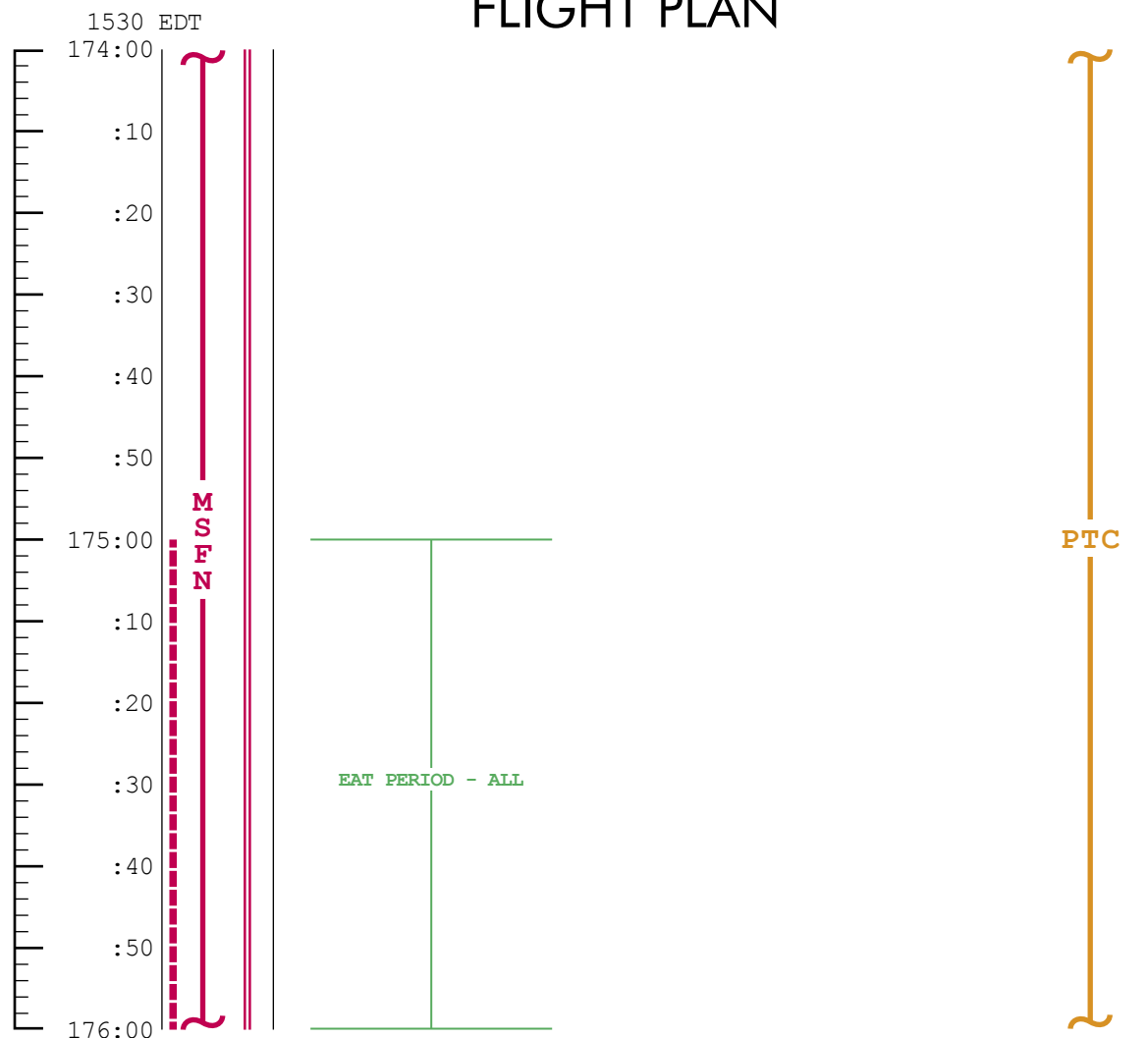

MISSION	EDITION	DATE	TIME	DAY / REV	PAGE
APOLLO 11	FINAL	JULY 1, 1969	174:00 - 176:00	8 / TEC	3-122

**MCC-H**

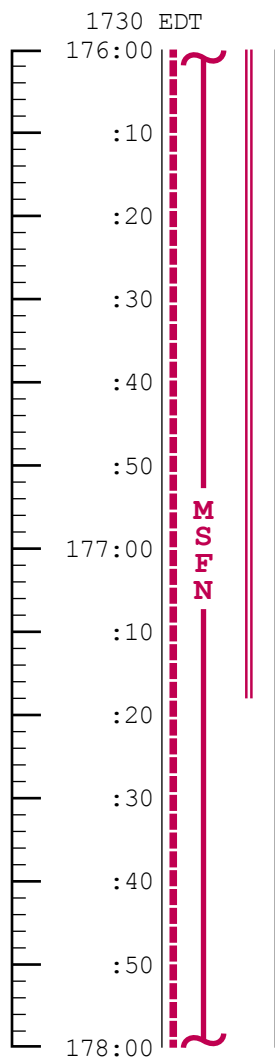

# FLIGHT PLAN

**NOTES**

P23 - NO COMM, (5 SETS)  
TEI +41:00 (176:30)  
DIPHDA (02), EFH  
MIRFAK (10), ENH  
ALDEBARAN (11), ENH  
CAPELLA (13), ENH  
CAPELLA (13), ENH



MISSION	EDITION	DATE	TIME	DAY / REV	PAGE
APOLLO 11	FINAL	JULY 1, 1969	176:00 - 178:00	8 / TEC	3-123

**MCC-H**

# FLIGHT PLAN

**NOTES**

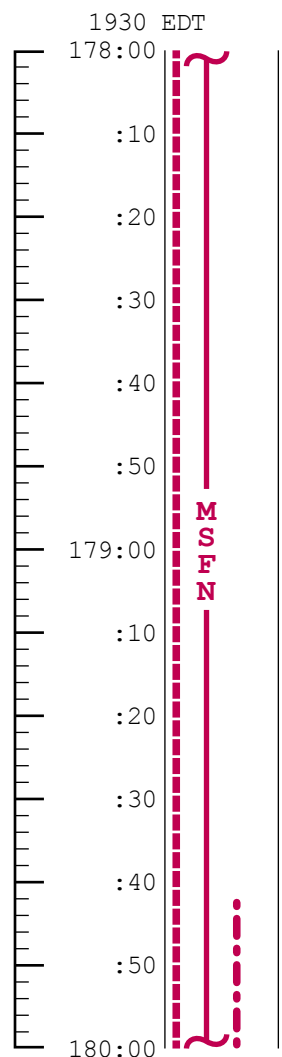

MISSION	EDITION	DATE	TIME	DAY / REV	PAGE
APOLLO 11	FINAL	JULY 1, 1969	178:00 - 180:00	8 / TEC	3-124

MCC-H

2130 EDT

# FLIGHT PLAN

## NOTES

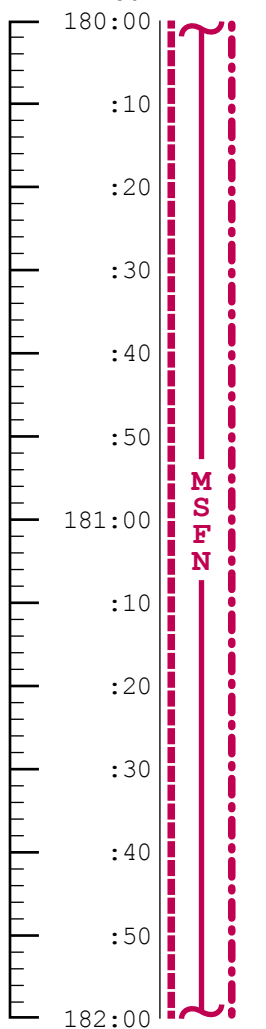

WIPE EXCESSIVE MOISTURE FROM TUNNEL HATCH AREA

O<sub>2</sub> FUEL CELL PURGE

CO<sub>2</sub> FILTER CHANGE NO. 14  
(16 INTO B, STORE 14 IN A4)

EAT PERIOD - ALL



P23 - NO COMM, (5 SETS)  
 TEI +44:30 (180:00)  
 DIPHDA (02), EFH  
 DIPHDA (02), EFH  
 MIRFAK (10), ENH  
 CAPELLA (13), ENH  
 CAPELLA (13), ENH

ONBOARD READOUT

BAT C \_\_\_\_\_

PYRO BAT A \_\_\_\_\_

PYRO BAT B \_\_\_\_\_

RCS A \_\_\_\_\_

B \_\_\_\_\_

C \_\_\_\_\_

D \_\_\_\_\_

DC IND SEL TO MNA OR MNB

MISSION	EDITION	DATE	TIME	DAY / REV	PAGE
APOLLO 11	FINAL	JULY 1, 1969	180:00 - 182:00	8 / TEC	3-125

MCC-H

# FLIGHT PLAN

NOTES

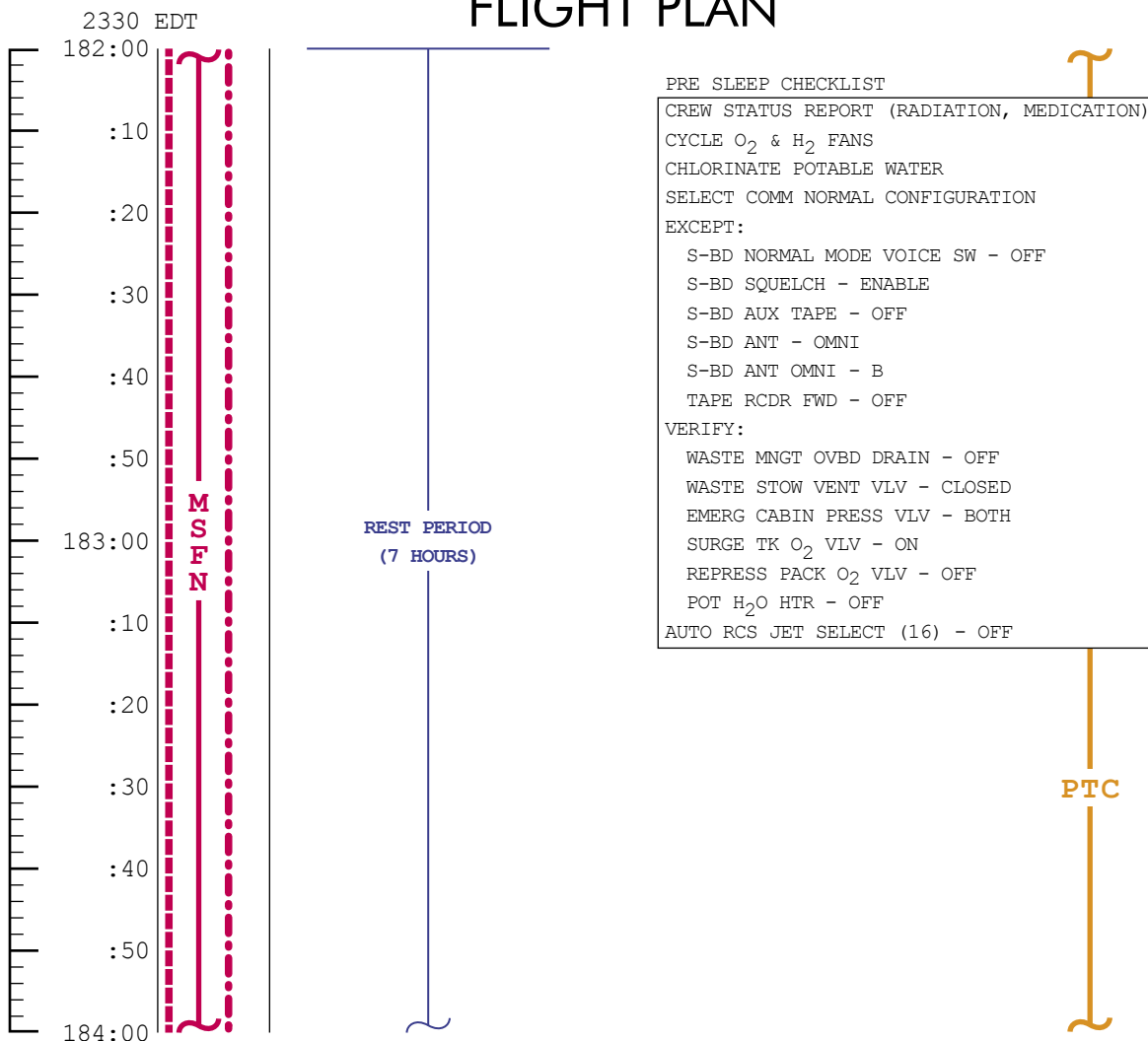

MISSION	EDITION	DATE	TIME	DAY / REV	PAGE
APOLLO 11	FINAL	JULY 1, 1969	182:00 - 184:00	8 / TEC	3-126

MCC-H

# FLIGHT PLAN

NOTES

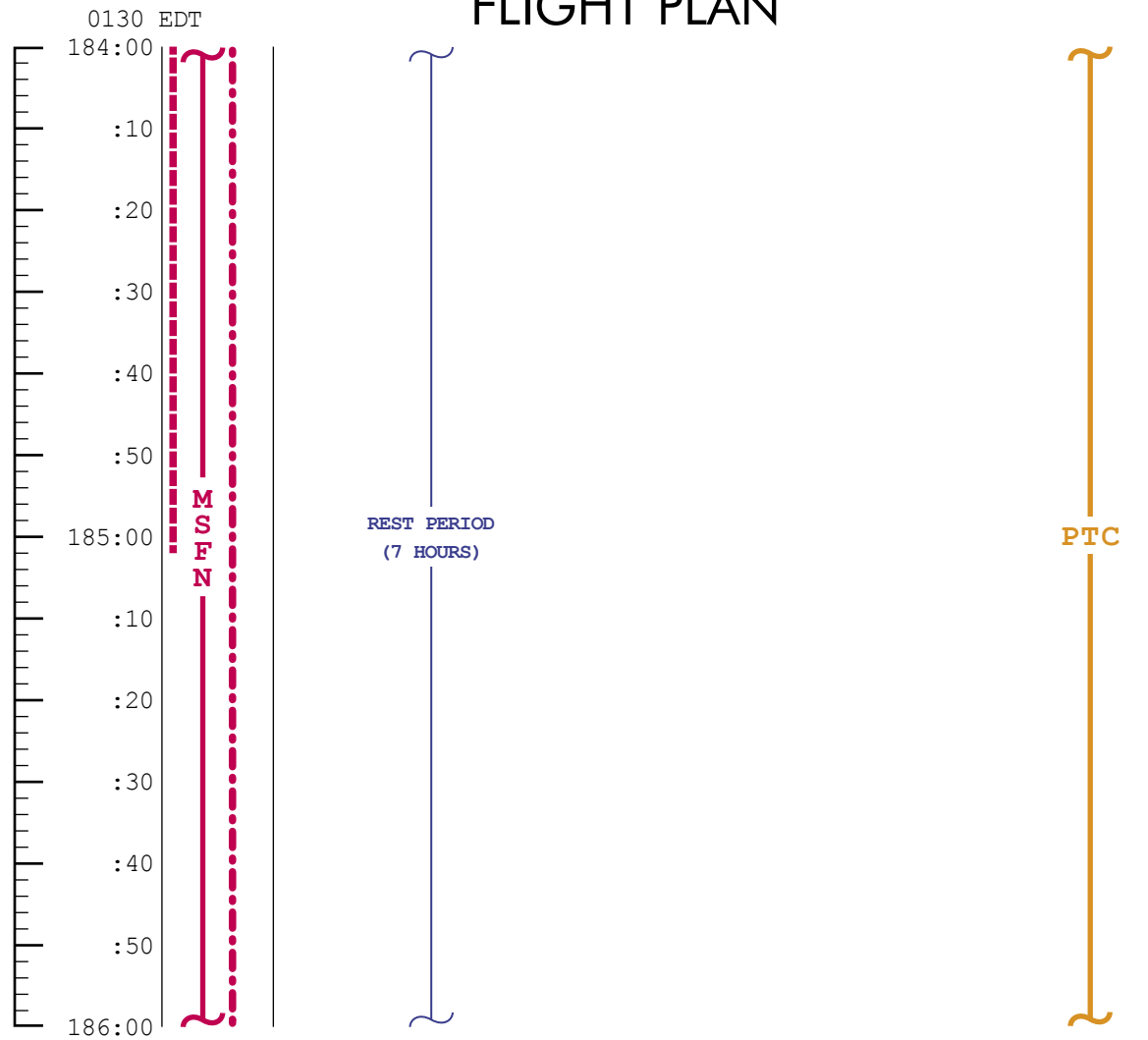

P23 - NO COMM, (5 SETS)  
TEI +50:00 (185:30)  
ALPHERATZ (01), EFH  
MIRFAK (10), ENH  
ALDEBARAN (11), ENH  
CAPELLA (13), ENH  
CAPELLA (13), ENH

MISSION	EDITION	DATE	TIME	DAY / REV	PAGE
APOLLO 11	FINAL	JULY 1, 1969	184:00 - 186:00	8 / TEC	3-127



**MCC-H**

# FLIGHT PLAN

**NOTES**

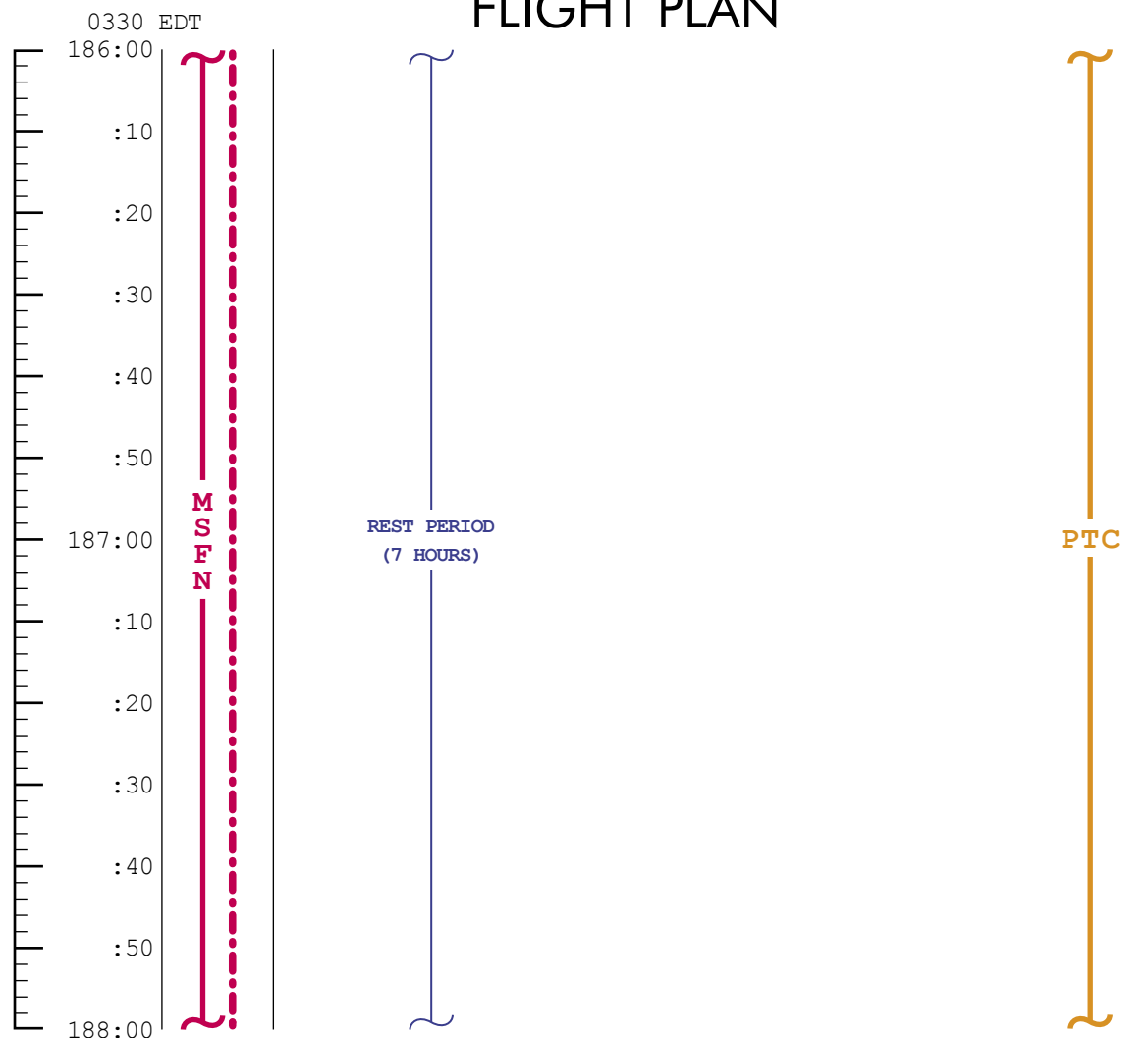

MISSION	EDITION	DATE	TIME	DAY / REV	PAGE
APOLLO 11	FINAL	JULY 1, 1969	186:00 - 188:00	8 / TEC	3-128

MCC-H

# FLIGHT PLAN

NOTES

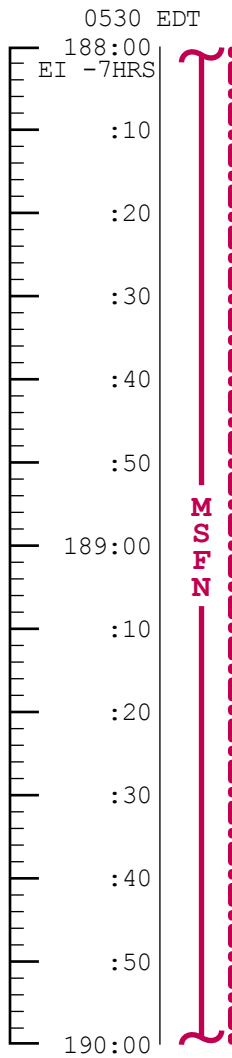

REST PERIOD  
(7 HOURS)

GO/NO-GO FOR MCC7  
REPORT CM RCS INJECTOR VALVE TEMPERATURE

EAT PERIOD - ALL

POST SLEEP CHECKLIST

CREW STATUS REPORT (SLEEP)

CYCLE O<sub>2</sub> & H<sub>2</sub> FANS

GDC ALIGN TO IMU

CONSUMABLES UPDATE

SELECT COMM NORMAL LUNAR

CONFIGURATION EXCEPT:

S-BD AUX TAPE - OFF

TAPE RCDR FWD - OFF

POT H<sub>2</sub>O HTR - ON

AUTO RCS JET SELECT (16) - ON

PTC

CONSUMABLE UPDATE  
(Δ FROM NOMINAL)

GET: \_\_\_\_\_

RCS TOT \_\_\_\_\_

A \_\_\_\_\_

B \_\_\_\_\_

C \_\_\_\_\_

D \_\_\_\_\_

H<sub>2</sub> TOT \_\_\_\_\_

O<sub>2</sub> TOT \_\_\_\_\_

MISSION	EDITION	DATE	TIME	DAY / REV	PAGE
APOLLO 11	FINAL	JULY 1, 1969	188:00 - 190:00	8 / TEC	3-129

**MCC-H**

0730 EDT

190:00

EI -5HRS

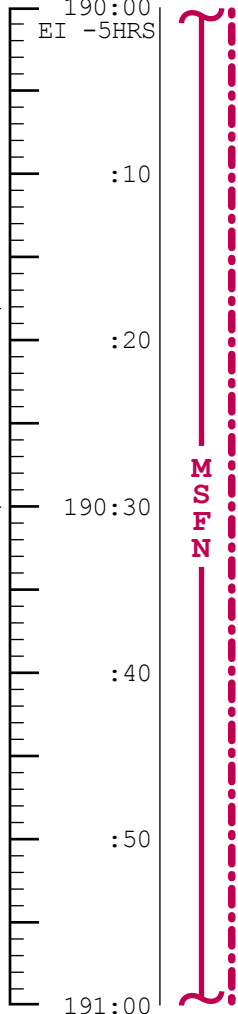

UPLINK CMC

CSM STATE VECTOR  
MCC7 TGT LOAD  
DESIRED ORIENT  
(ENTRY)  
ENTRY LAT & LONG

UPDATE

MCC7 MNVR PAD  
ENTRY PAD

190:30

:40

:50

191:00

# FLIGHT PLAN

DON MAE WEST & FOOT RESTRAINTS

V66 - TRANS CSM STATE VECTOR TO LM SLOT

RECORD MCC7 MNVR PAD & ENTRY PAD

EPS CHECK

SPS CHECK  
CM RCS MON CK

SM RCS MON CK

C&W SYS CK

CMC SELF TEST

DSKY COND LT TEST

**NOTES**

P23 - NO COMM, (5 SETS)  
TEI +54:30 (190:00)  
ALPHERATZ (01), EFH  
MIRFAK (10), ENH  
ALDEBARAN (11), ENH  
CAPELLA (13), ENH  
CAPELLA (13), ENH

PTC

MISSION	EDITION	DATE	TIME	DAY / REV	PAGE
APOLLO 11	FINAL	JULY 1, 1969	190:00 - 191:00	9 / TEC	3-130

MCC-H

0830 EDT

# FLIGHT PLAN

NOTES

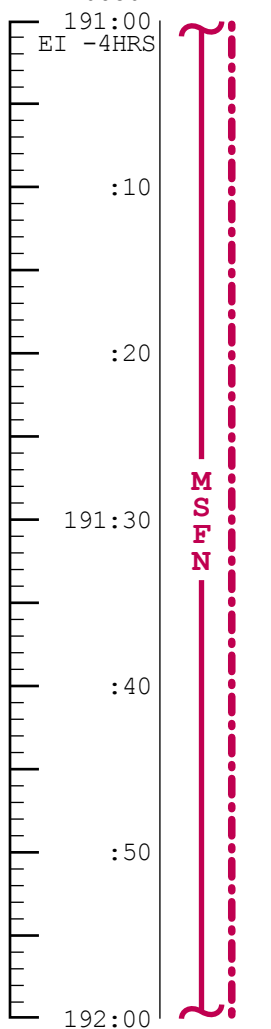

IMU REALIGN - P52  
OPTION 1 - PREFERRED

EXT ΔV - P30

SPS/RCS THRUST - P40/41

MNVR TO BURN ATT

SXT STAR CK

EMS ΔV TEST

SM RCS MON CK

GDC ALIGN TO IMU

P52 - (ENTRY REFSMMAT)

N71: \_ \_ \_ / \_ \_ \_

N05: \_ \_ \_ . \_ \_ \_

N93:

X \_ \_ . \_ \_ \_

Y \_ \_ . \_ \_ \_

Z \_ \_ . \_ \_ \_

GET \_ \_ \_ : \_ \_ \_ : \_ \_ \_

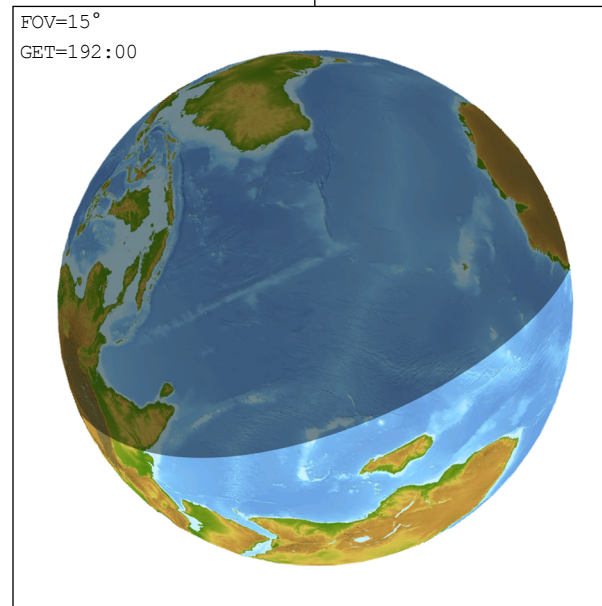

MISSION	EDITION	DATE	TIME	DAY / REV	PAGE
APOLLO 11	FINAL	JULY 1, 1969	191:00 - 192:00	9 / TEC	3-131

THIS PAGE INTENTIONALLY LEFT BLANK.

MCC  
BURN CHART

	P OR Y RATES	ATT DEVIATION	SHUTDOWN TIME	RESIDUALS
MCC7	10°/SEC TAKEOVER	10° TAKEOVER	BT +1 SEC	TRIM X AXIS ONLY

**MCC-H**

# FLIGHT PLAN

**NOTES**

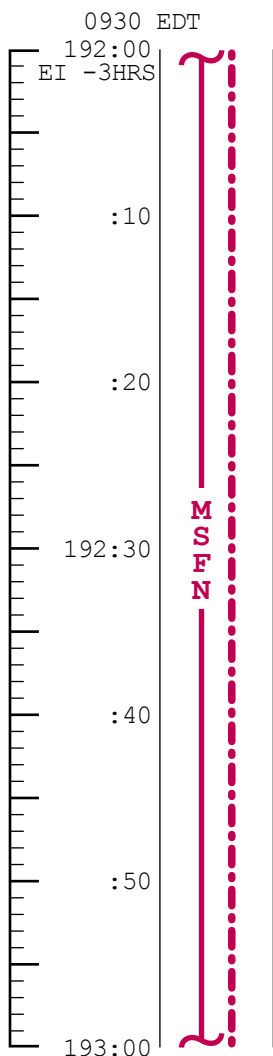

MCC7  $\Delta V$ =NOMINALLY ZERO

SM RCS MON CK  
 SPS MON CK  
 BURN STATUS REPORT  
 V66 - TRANS CSM STATE VECTOR TO LM SLOT

P23 - NO COMM, (5 SETS)  
 TEI +57:00 (192:30)  
 MENKAR (07), ENH  
 CAPELLA (13), ENH  
 CAPELLA (13), ENH

GO/NO-GO FOR PYRO ARM SEQUENCE  
 VHF ACTIVATION

BURN STATUS REPORT				
X	X	<input type="checkbox"/>	•	$\Delta TIG$
X	X		•	BT
<input type="checkbox"/>			•	$V_{gx}$
TRIM				
X	X	X		R
X	X	X		P
X	X	X		Y
<input type="checkbox"/>			•	$V_{gx}$
<input type="checkbox"/>			•	$V_{gy}$
<input type="checkbox"/>			•	$V_{gz}$
<input type="checkbox"/>			•	$\Delta V_C$
X	X	X		FUEL
X	X	X		OX
X	X	X		UNBAL

GO/NO-GO

MISSION	EDITION	DATE	TIME	DAY / REV	PAGE
APOLLO 11	FINAL	JULY 1, 1969	192:00 - 193:00	9 / TEC	3-132

MCC-H

# FLIGHT PLAN

NOTES

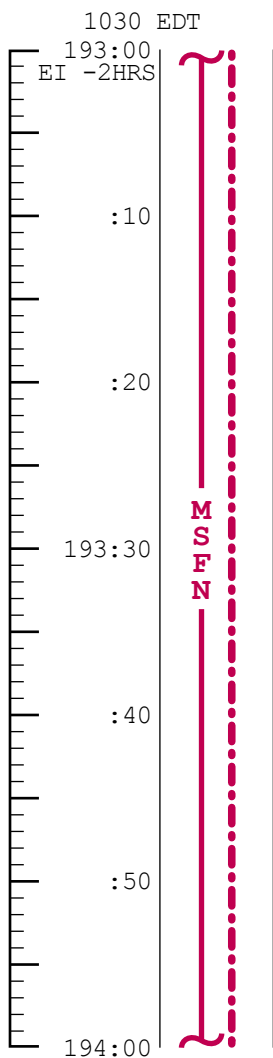

LOGIC SEQUENCE CHECK

MNVR TO ENTRY ATTITUDE

COAS STAR CHECK

SXT STAR CHECK

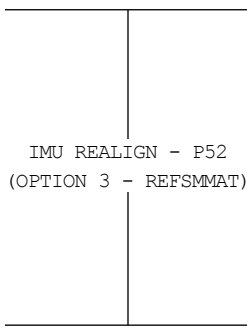

IMU REALIGN - P52  
(OPTION 3 - REFSMMAT)

GDC ALIGN TO IMU  
CM RCS PREHEAT

P52 - (ENTRY REFSMMAT)
N71: _ _ / _ _
N05: _ _ . _ _
N93:
X _ _ . _ _
Y _ _ . _ _
Z _ _ . _ _
GET _ _ : _ _ : _ _

MISSION	EDITION	DATE	TIME	DAY / REV	PAGE
APOLLO 11	FINAL	JULY 1, 1969	193:00 - 194:00	9 / TEC	3-133



MCC-H

# FLIGHT PLAN

NOTES

1130 EDT

194:00

EI -1HRS

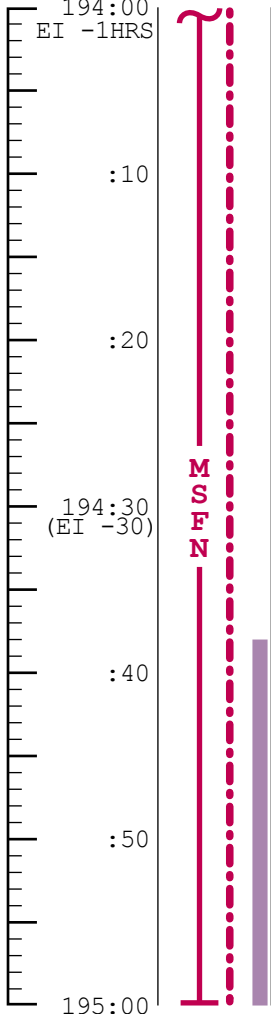

UPDATE

ENTRY PAD  
RCVY PAD

UPLINK

CSM STATE VECTOR

:10

:20

194:30  
(EI -30)

:40

:50

195:00

PRIMARY EVAPORATOR ACTIVATION

FINAL GDC DRIFT CHECK  
TERM CM RCS PREHEAT

SECONDARY EVAPORATOR ACTIVATION  
PYRO BATTERY CHECK  
RECORD ENTRY PAD AND RECOVERY DATA

P27 UPDATE - V66 - TRANS CSM STATE VECTOR TO LM SLOT

SET DET TO RRT  
EMS INITIALIZATION  
RSI ALIGN TO GDC

CM RCS CK  
ENTRY BATTS - ON

SEPARATION CHECKLIST  
GO FOR PYRO ARM

P61 ENTRY PREP  
MNVR TO CM/SM SEP ATT

CM/SM SEP

P62 - ENTRY ATTITUDE  
MNVR TO ENTRY ATT

GO FOR PYRO ARM

MISSION	EDITION	DATE	TIME	DAY / REV	PAGE
APOLLO 11	FINAL	JULY 1, 1969	194:00 - 195:00	9 / TEC	3-134

MCC-H

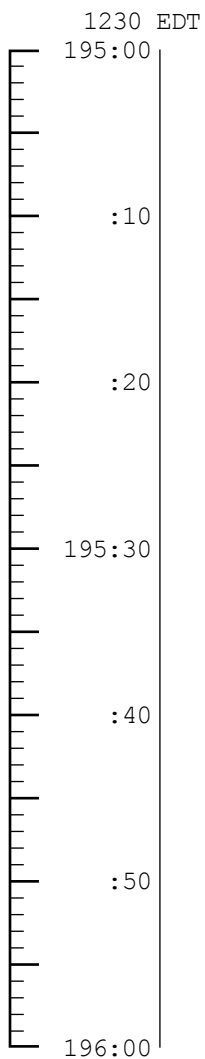

# FLIGHT PLAN

NOTES

P63 - ENTRY INITIATE

EI - GET = 195:03:27

P64 - ENTRY POST .05G

TRAJECTORY EVENT	TIME FROM ENTRY INTERFACE MIN:SEC
400,000 FEET (GET 195:03:27)	00:00
ENTER S-BAND BLACKOUT	00:18
0.05G	00:28
KA - INITIATE CONSTANT DRAG	00:52
RDOT = -700 FPS	01:18
PEAK G (6.6)	01:22
SUBCIRCULAR VELOCITY	02:08
P64 TO P67	02:08
EXIT S-BAND BLACKOUT	03:24
GUIDANCE TERMINATION	07:14
DROGUE DEPLOYMENT	08:12
MAIN DEPLOYMENT	09:00
SPLASHDOWN	13:55

$\gamma = -6.52^\circ$ ,  $L/D = 0.295$ ,  $V = 36,309$  &  $R = 1285$

MISSION	EDITION	DATE	TIME	DAY / REV	PAGE
APOLLO 11	FINAL	JULY 1, 1969	195:00 - 196:00	9 / TEC	3-135

SECTION IV

**DETAILED TEST OBJECTIVES**



## SECTION 4

### DETAILED OBJECTIVE ACTIVITIES

This section contains the activity summaries which reflect the test objectives for Mission G as described in „Mission Requirements G Type Mission“, SPD9-R-038, Change A dated May 1, 1969. These activity summaries are presented in the approximate sequence in which they are planned to occur during the mission.

Each activity summary provides the following information:

- A. TEST OBJECTIVES. This is the listing of the Functional Test Objectives (complete or partial) which relate to the particular activity;
- B. TEST REQUIREMENTS. Here the special test prerequisites (and mission phase if necessary) are presented in addition to brief statements of the requirements for performing the activity;
- C. TEST PROCEDURES/CHECKLISTS. These are the procedural references for the performance of the activity as far as the test objectives are concerned; and
- D. DATA REQUIREMENTS. This part of the summary identifies the gross data which are needed for evaluation of test results in terms of flight crew and ground support requirements.

Cross references for relating Detailed and Functional Test Objectives with the activity summaries and relating activities to Functional Test Objectives, are provided as the initial part of this section.

The following ground rules are to be used in implementing data requirements:

- A. The collection of highly desirable (HD) data should not constrain the timeline of the crew procedures.
- B. Post-flight debriefing requirements which are fulfilled by real time transmission of data per the DATA REQUIREMENTS sections may be deleted from the post-flight debriefing.

All of the Test Requirements have not been totally implemented into the mission timeline. These items are identified in this section as „Not Implemented“ or with the conditions by which they will be implemented.

TABLE 4-1  
MISSION ACTIVITY AND  
TEST OBJECTIVE CROSS REFERENCE

<u>ACTIVITY</u>	<u>FTO</u>
LM Descent	D-1, G-1, G-3, H-1, M-1
Lunar Surface Navigation	G-1, G-2, G-3, L-4, M-2
EVA Preparation and Egress	B-1, B-2, C-1, C-2, C-3, L-1
Surface Sample Collection	A-1, E-1, F-1, F-2, I-3, J-2, J-3, J-4, M-3
External LM Observations and Photography	D-1, D-2, D-3, D-4, L-2, M-3
Lunar Surface Observations and Photography	E-1, E-2, E-3, H-2, J-5, L-3, L-4, M-3
Experiment Deployment/Conduct	S-031, S-078, S-080
Post EVA Operations	B-1, C-1, C-2
Contamination Prevention	I-1, I-2

TABLE 4-2  
TEST OBJECTIVE/MISSION ACTIVITY  
CROSS REFERENCE

DTO/FTO NUMBER	TEST OBJECTIVE	MISSION ACTIVITY	SECTION PAGE NO.
A A-1	Contingency Sample Collection Provide a Contingency Lunar Surface Sample	Surface Sample Collection	4 - 13
B B-1	Lunar Surface EVA Operations Demonstrate Egress-To/Ingress-From the Lunar Surface	EVA Preparation and Egress Post EVA Operations	4 - 10 4 - 21
B-2	Evaluate Crew Lunar Surface EVA Capability	EVA Preparation and Egress	4 - 10
C C-1	EMU Lunar Surface Operations EMU Capability to Provide a Habitable Environment	EVA Preparation and Egress	4 - 10
C-2	EMU Effects on Crew Mobility, Dexterity & Comfort	EVA Preparation and Egress	4 - 10
C-3	Demonstrate EVA Data/Voice Communications	EVA Preparation and Egress	4 - 10
D D-1	Landing Effects on LM LM Landing Gear Performance Under Landing Conditions	LM Descent	4 - 6
D-2	Effects of Landing on LM Structure and Components	External LM Observ/Photo	4 - 15
D-3	Descent Engine Skirt Damage/Clearance After Landing	External LM Observ/Photo	4 - 15
D-4	Effects of RCS Plume Impingement on LM Structure & Components	External LM Observ/Photo	4 - 15
E E-1	Lunar Surface Characteristics Data on Behavior/Characteristics of the Lunar Surface	Surface Sample Collection	4 - 13
E-2	Lunar Soil Erosion from DPS Plume Impingement	Lunar Surface Observ/Photo	4 - 17
E-3	Effect of DPS Venting on the Lunar Surface	Lunar Surface Observ/Photo	4 - 17
F F-1	Bulk Sample Collection Collect Rock Samples and Fine Grained Material	Surface Sample Collection	4 - 13
F-2	Photograph Collection Area of Samples	Surface Sample Collection	4 - 13

TABLE 4-2  
TEST OBJECTIVE/MISSION ACTIVITY  
CROSS REFERENCE

DTO/FTO NUMBER	TEST OBJECTIVE	MISSION ACTIVITY	SECTION PAGE NO.
G G-1	Landed LM Location Determine Location of Landed LM from LM Data	LM Descent Lunar Surface Navigation	4 - 6 4 - 8
G-2 G-3	Determine Location of Landed LM from CSM Data Capability of Locating Landed LM in Real Time	Lunar Surface Navigation LM Descent Lunar Surface Navigation	4 - 8 4 - 6 4 - 8
H H-1 H-2	Lunar Environment Visibility Data on Landing Aids & Final Approach Visibility Crew Performance of Visual Tasks on Lunar Surface	LM Descent Lunar Surface Observ/Photo	4 - 6 4 - 17
I I-1 I-2 I-3	Assessment of Contamination by Lunar Material Prevent Earth Contamination by Lunar Exposed Materials Minimize Crew/CM Contamination by Lunar Exposed Materials Lunar Sample for Quarantine Testing	Contamination Prevention Contamination Prevention Surface Sample Collection	4 - 22 4 - 22 4 - 13
J J-1 J-2 J-3 J-4 J-5	Documented Sample Collection Obtain an Aseptic Sample of the Lunar Surface Obtain a Core Sample of the Lunar Surface Collect Lunar Geologic Samples Collect a Lunar Environment Sample Study and Describe Lunar Topography Features	Deleted Surface Sample Collection Surface Sample Collection Surface Sample Collection Lunar Surface Observ/Photo	4 - 13 4 - 13 4 - 13 4 - 17
K	Lunar Surface Structure Photograph (Objective Deleted)	Deleted	



TABLE 4-2  
TEST OBJECTIVE/MISSION ACTIVITY  
CROSS REFERENCE

DTO/FTO NUMBER	TEST OBJECTIVE	MISSION ACTIVITY	SECTION PAGE NO.
L L-1 L-2 L-3 L-4  L-5	Television Coverage TV Coverage of Astronaut Descending to the Lunar Surface TV Coverage of External Landed LM TV Coverage of Lunar Surface Near LM TV Panoramic Coverage of Distant Terrain Features  TV Coverage of Astronaut Activities on the Lunar Surface	EVA Preparation and Egress External LM Observ/Photo Lunar Surface Observ/Photo Lunar Surface Navigation Lunar Surface Observ/Photo Lunar Surface Observ/Photo	4 - 10 4 - 15 4 - 17 4 - 8 4 - 17 4 - 17
M M-1 M-2 M-3	Photographic Coverage Photograph Lunar Surface During LM Descent Photograph Lunar Surface Post Touchdown/Pre EVA Obtain Photographs During EVA	LM Descent Lunar Surface Navigation Surface Sample Collections External LM Observ/Photo Lunar Surface Observ/Photo	4 - 6 4 - 8 4 - 13 4 - 15 4 - 17
S-031 S-078 S-080	Lunar Passive Seismology Laser Ranging Retro-Reflector Solar Wind Composition	Experiment Deployment/Conduct Experiment Deployment/Conduct Experiment Deployment/Conduct	4 - 20 4 - 20 4 - 20

## LM DESCENT

### A. Test Objective

- D-1 LM Landing Gear Performance Under Landing Conditions
- G-1 Location of the Landed LM from LM Data
- G-3 Capability of Locating the Landed LM in Real Time from LM/CSM/MSFN Data
- H-1 Data on Landing Aids and Final Approach Visibility
- M-1 Photograph Lunar Surface During LM Descent

### B. Test Requirements

1. Determine landing site visibility, extent of washout and visibility of landing site landmarks. [H]
2. Photograph the landing site during the approach through the LM pilot's window with the data acquisition camera. [G, H, M]
3. Evaluate landing aids, i.e., Landing Point Designator, maps, photographs. [G, H]
4. Assess visual phenomena during LM landing which are significantly different from expected. [H]
5. Voice anotate location and identity of features during final descent. [G]
6. Determine landing location in real time by description of terrain features during descent. [G]
7. Assess LM landing conditions on the lunar surface. [D]

### C. Procedures/Checklist

1. Photographic and Television Operations Plan.
2. Descent Procedures Document.

### D. Data Requirements

1. Flight Crew Reports/Logs/Photographs
  - a. LM crew comments on landing site visibility during final approach and landing phases and on effectiveness of the Landing Point Designator and landing site recognition aids. [H] (M)
  - b. GET at start of data acquisition camera photographs during LM final approach. [H] (M)
  - c. Voice track regarding observations of surface features during the descent phase. [G] (M)
  - d. Photographs of the landing site and surrounding lunar surface features taken through a LM window during descent. [G, M] (M)
  - e. Data Acquisition Camera photographs of the landing site from high gate to touchdown. [H, M] (M)
  - f. Photographs of the landing site and surrounding lunar surface features taken through a LM window during descent. [G, M] (N)
  - g. Comments on any lunar dust observed during the final approach, the severity of the landing and vehicle stability after touchdown. [D] (M)
2. Ground Support
  - a. LM TM HBR. [D, G, H] (M)
  - b. LM TM LBR. [D, G] (M)

c. LM BET from DOI through touchdown. [G, H] (M)

d. MSFN tracking data of LM from acquisition of signal through touchdown.  
[G] (F4)

## LUNAR SURFACE NAVIGATION

### A. Test Objectives

- G-1 Determine the Location of the Landed LM from LM Data
- G-2 Determine the Location of the Landed LM from CSM Data
- G-3 Determine Capability of Locating the Landed LM in Real Time from LM/CSM/MSFN Data
- L-4 Panoramic Coverage of Distant Terrain Features
- M-2 Photograph Lunar Surface Post Touchdown/Pre EVA

### B. Test Requirements

1. Correlate lunar surface features surrounding the landing site with photomaps and mark the LM location. [G, L, M]
2. Photograph terrain features thru the LM window to correlate LM location. [G, M]
3. Obtain two sets of LM IMU alignments after landing [G]
4. Provide TV coverage of prominent terrain features. [G, L]
5. Track the landed LM from the CSM during two orbital passes. Mark on a landmark near the landed LM. [G] - (Only one pass is implemented.)
6. Track the CSM with LM RR during one pass. [G] - (Not Implemented.)
7. Obtain 70 MM photographs of the landed LM or its shadow and the surrounding lunar features. [G]
8. Assist MCCH in determining the landing LM location in real time. [G, L]

### C. Procedures/Checklist

1. Photographic and Television Operations Plan.
2. LM AOH, „PGNCS Lunar Surface Align Program (P57)“.
3. LM AOH, „Lunar Surface Navigation Program (P22)“
4. CSM AOH, „Orbital Navigation (P22)“.

### D. Data Requirements

1. Flight Crew Reports/Logs/Photographs
  - a. Estimate of the landed LM location on lunar photomaps. [G] (M)
  - b. Comments by LM crew regarding any difficulties encountered in estimating the location of the LM with respect to lunar surface features. [G] (HD)
  - c. Comments by LM crewman on location of landed LM with respect to prominent terrain features. [G] (M)
  - d. Obtain high resolution photographs of the landing area from the CSM. [G] (M)
  - e. Photographs of the landing site and surrounding lunar surface features taken through a LM window after landing. [G, M] (M)
  - f. Provide TV coverage of the lunar surface as viewed from the LM. [G, L] (M)
2. Ground Support
  - a. LM TLM HBR. [G] (M)
  - b. LM TLM LBR. [G] (M)

- c. BET of CSM during the lunar surface phase. [G] (M)
- d. BET of LM from DOI through touchdown. [G] (M)
- e. Photographs of the landing area obtained during previous lunar missions. [G] (M)
- f. Post-scan conversion video tape of all TV coverage. [L] (M)
- g. Estimate solar illumination established by mission geometry. [L] (M)
- h. Reflectivity and geometry of surfaces contributing to indirect illumination. [L] (HD)

## EVA PREPARATION AND EGRESS

### A. Test Objectives

- B-1 Demonstrate Egress-to/Ingress-from the Lunar Surface
- B-2 Evaluate Crew Lunar Surface EVA Capability
- C-1 EMU Capability to Provide a Habitable Environment
- C-2 EMU Effects on Crew Mobility/Dexterity/Comfort
- C-3 Data/Voice Communications Capability During EVA
- L-1 TV Coverage of an Astronaut Descending to the Lunar Surface

### B. Test Requirements

1. Perform EVA preparations. [C]
2. Release the MESA pallet with pre-mounted TV camera and turn camera power on prior to descent to the lunar surface. [L]
3. Egress to the lunar surface. [B, C]
4. Deploy and set the TV camera to provide TV coverage of the lunar surface EVA. [L]
5. During EVA, communicate with MSFN via the EVA-LM-MSFN two way voice relay. [C]
6. Two-way voice communications to be performed between two EVA crewmen. [C]
7. EMU and biomedical data from two EVA crewmen will be simultaneously transmitted to MSFN via EVA-LM-MSFN one-way relay. [C]

### C. Procedures/Checklist

1. EVA Procedures Document.
2. Lunar Surface Operations Plan.

### D. Data Requirements

1. Flight Crew Reports/Logs/Photographs
  - a. Notify MSFN of the initial and final positions of the PLSS water diverter valve, primary oxygen shutoff valve and water shutoff/relief valve each time they are changed. [C] (M)
  - b. Notify MSFN when PLSS; High O2 flowrate, low vent flow, low feed water pressure or PGA pressure low remote control unit status indicators and audible warning tone come on. [C] (M)
  - c. Record EMU radiation dosimeter readings just prior to the EVA. [C] (M)
  - d. Notify MSFN if noxious odors occur or any condensation on the visor assembly. [C] (HD)
  - e. Comment on the adequacy of procedures and difficulties encountered during donning of EMU equipment. [C] (HD)
  - f. Comment on time required and adequacy of the EMU checkout procedures. [C] (MD)
  - g. Comment on the adequacy of EMU thermal environment when walking from a sunlit area to shadow and vice versa. [C] (M)
  - h. Comment on estimated energy expenditure and comfort as compared to simulation experience. [C] (HD)
  - i. Provide data on the adequacy of hardware and procedures, and the time required to perform the egress from the LM. [B] (M)

j. Comment on voice quality for EVA-EVA and EVA-LM-MSFN communications.  
[C] (M)

k. Provide sequence camera coverage and TV camera coverage of: [B, M] (M)

1) A crew member descending to the lunar surface.

2) A crew member walking on the lunar surface.

3) A crew member performing lunar surface EVA operations.

## 2. Ground Support

a. LM TM FM. [B, C] (M)

b. Ground recorded TV signals. [B] (HD)

c. LM TM LBR. [L] (HD)

d. Post-scan conversion video tape of all TV coverage. [L] (M)

e. Record of S-band signal strength during video transmission. [L] (HD)

f. GET at beginning and end of TV transmission. [L]

g. Time period, if any, when LBR TM (in lieu of HBR TM) transmitted  
simultaneously with TV data. [L] (M)

h. Identity of ground station(s) used to record video transmission from  
LM. [L] (M)

i. Time period, if any, when erectable antenna used to transmit TV data.  
[L] (M)

j. Estimate of incident illumination. [L] (M)

k. LM position on lunar surface. [H] (HD)

l. MSFN recording of EVA-LM-MSFN voice. [C] (M)

## SURFACE SAMPLE COLLECTION

### A. Test Objectives

A-1 Provide a Contingency Lunar Surface Sample  
E-1 Behavior and Characteristics of the Lunar Surface  
F-1 Collect Rock Samples and Fine Grained Material  
F-2 Photograph Collection Area of Samples  
I-3 Obtain a Lunar Sample for Quarantine Testing  
J-2 Obtain a Core Sample of the Lunar Surface  
J-3 Collect Lunar Geologic Samples  
J-4 Collect a Lunar Environment Sample  
M-3 Obtain Photographs of Geologic Inspection & Sampling

### B. Test Requirements

1. Contingency Sample - Obtain upon first descending to the lunar surface. [A]
2. Bulk Material - Obtain 30 pounds consisting of 1/3 fragmentary and 2/3 loose samples. [F]
3. Core Sample - Obtain with the drive tube. [I, J]
4. Geologic Samples - Obtain using tools stowed in the MESA. Photograph sample areas. [J, M]
5. Lunar Environment Sample - Seal in gas analysis container. [J]

### C. Procedures/Checklist

1. Lunar Landing Mission Flight Plan.
2. Lunar Surface Operations Plan.
3. Photographic and Television Operations Plan.

### D. Data Requirements

1. Flight Crew Reports/Logs/Photographs
  - a. Record areas in relation to LM where samples were collected. [A, F, J] (M)
  - b. Record unusual lunar surface observations. [A, F, J] (M)
  - c. Comment on soil behavior during collection of Bulk Sample. [E] (M)
  - d. Comment on soil behavior during collection of Documented Sample. [E] (HD)
  - e. Estimates of volume of fine grained material collected in one bag of the Documented Sample. [E] (HD)
  - f. Take photographs during sample collection. [A, F] (HD)
  - g. Photograph the lunar surface sample areas and of the samples as defined in the Photographic Operations Plan. [J] (M)
2. Ground Support
  - a. LM position on lunar surface. [J] (M)
  - b. MSFN recordings of all MSFN/EVA voice conferences. [J] (M)



## EXTERNAL LM OBSERVATIONS AND PHOTOGRAPHY

### A. Test Objectives

- D-1 Effects of Landing on LM Landing Gear
- D-2 Effects of Landing on LM Structure and Components
- D-3 Descent Engine Skirt Damage and Clearance After Landing
- D-4 Effects of RCS Plume Impingement on LM Structure and Components
- L-2 TV Coverage of External Landed LM
- M-3 Obtain Photographs of Landed LM

### B. Test Requirements

1. Operate the TV camera to provide an external view of the LM. [L]
2. Photograph any observed LM external structural damage. [D, M]
3. Determine descent engine skirt ground clearance. [D, M]
4. Photograph any effects of RCS plume impingement observed. [D, M]
5. Obtain photographs of any lunar material collected on the LM. [D, M]

### C. Procedures/Checklist

1. Mission G Photographic and Television Operations Plan.

### D. Data Requirements

#### 1. Flight Crew Reports/Logs/Photographs

- a. Comment on any LM component damage to include any visible discoloration or lunar soil accumulation. [D] (M)
- b. Comments describing any descent engine skirt damage and estimate of any skirt ground clearance. [D] (M)
- c. If the landing gear strut assembly photographs cannot be obtained, estimate the amount of stroking of each primary and secondary strut assembly. [D] (M)
- d. Photograph the landing gear to show the stroking of the primary and secondary strut assemblies. [D, M] (M)
- e. Photograph the LM exterior showing any structural damage. [D, M] (M)
- f. Photograph each landing gear assembly along the Z axis and the Y axis. [D, M] (HD)
- g. Photograph the descent engine skirt. [D, M] (HD)
- h. Photograph the LM base heat shield. [D, M] (HD)
- i. Photograph the LM exterior, i.e., structure antenna, RCS jets, windows and foot pads. [D, M] (HD)
- j. Photograph soil accumulation on the LM. [D, M] (HD)
- k. Photographs by the close up stereo camera of lunar material adhering to LM surfaces. [M] (HD)

#### 2. Ground Support

- a. LM TM HBR. [D] (M), [L] (HD)
- b. LM Mass, center of gravity and mass moment of inertia calculations. [E] (M)
- c. Video tape of all TV coverage. [L] (M)

- d. Record of S-band signal strength during TV coverage. [L] (HD)
- e. GET at beginning and end of TV operations.
- f. Time period of simultaneous LBR TM and TV transmission. [L] (M)
- g. Identification of ground station(s) used to record video transmission.  
[L] (M)
- h. Time period when erectable antenna was used to transmit from lunar  
surface. [L] (M)

## LUNAR SURFACE OBSERVATIONS AND PHOTOGRAPHY

### A. Test Objectives

- E-1 Behavior and Characteristics of the Lunar Surface
- E-2 Erosion of Lunar Surface by DPS Plume Impingement
- E-3 Effect of Any DPS Venting on the Lunar Surface
- H-2 Crew Performance of Visual Tasks on the Lunar Surface
- J-5 Study and Description of Lunar Topography Features
- L-3 TV Coverage of Lunar Surface Near LM
- L-4 TV Panoramic Coverage of Distant Terrain Features
- L-5 Coverage of Astronaut Activities on the Lunar Surface
- M-3 Obtain Photographs During EVA

### B. Test Requirements

1. Provide TV coverage of the lunar surface in the vicinity of the LM and panoramic scenes of distant terrain features. [L]
2. Photograph the lunar terrain at various azimuths with respect to the sun including 9, 90 and 180 degrees. Comment on ability to see terrain features in these areas. [H, M]
3. Estimate the distance to prominent terrain features within the field of view of photographs taken. [H]
4. Observe lunar surface characteristics including texture, consistency, compressibility, cohesiveness, adhesiveness, density and color. [E]
5. Study and photograph the mechanical behavior of the lunar surface from interactions of astronauts boots and equipment with the lunar soil, erosion by DPS plume impingement and DPS venting. [E, M]
6. Describe and photograph field relationships such as shape, size, range, pattern of alignment or distribution of all accessible types of lunar topographic features. [J,M]
7. Photograph the structure of lunar surface material in its natural state. [M]

### C. Procedures/Checklist

1. Mission G Photographic and Television Operations Plan.

### D. Data Requirements

1. Flight Crew Report/Logs/Photographs
  - a. Report condition of the temperature indicator viewing ports on the TV camera at the beginning and the end of the TV operations. [L] (M)
  - b. Position of the TV camera scan rate switch at start of TV operation. [L] (M)
  - c. Comments describing the interaction between astronaut boots and lunar surface while walking. [E] (M)
  - d. Comments on slope and roughness characteristics of the landing terrain to include descriptions of craters, depressions, embankments or other obstacles. [E] (M)
  - e. Comments on the color and texture of both undisturbed and mechanically disturbed areas of the lunar surface. [E] (M)
  - f. Comments on lunar soil conditions adjacent to DPS vents to include any discoloration. [E] (M)
  - g. Comments describing the lunar surface penetration by the Solar Wind Composition Staff and core sample tool under their own weight and the

estimated force. [E] (Mandatory for either the staff or the core sample tool: highly desirable for the other.)

- h. Comments on lunar soil erosion as caused by the DPS plume impingement during landing. [E] (M)
- i. Record vent valves opened. [E] (M)
- j. Photograph the lunar surface showing DPS plume impingement erosive effects. [E, M] (M)
- k. Photograph the lunar surface adjacent to DPS vents if soil discoloration is observed. [E, M] (M)
- l. Photograph an astronaut footprint showing interaction between astronaut boots and lunar surface. [E, M] (M)
- m. Photograph the Solar Wind Composition Experiment Staff and core sampling tool after being inserted to their maximum depth as penetrometers. [E, M] (HD)
- n. Photograph the natural slopes, crater walls and embankments in the vicinity of the landing site. [E,M] (M)
- o. Photograph from the CSM of the lunar surface surrounding the LM. [E, M] (HD)
- p. Comments on the visibility of the lunar terrain as a function of the sun/viewing angle and on their ability to perform visual tasks while on the lunar surface. [H] (M)
- q. Comments on color/contrast perception. [H] (M)
- r. Comments on and significant unexpected visual phenomena. [H] (M)
- s. Estimate of distance to at least one prominent terrain feature within the field of view of the photographs in item »t« below. [H] (M)
- t. Photograph the lunar terrain at various sun azimuths to include 0 degrees, 90 degrees and 180 degrees. [H, M] (M)
- u. Photograph any unexpected visual phenomena. [H, M] (HD)
- v. Photograph a representative depression caused by use of the scoop in collecting fine grained fragmental material. [E, M] (M)
- w. Photograph one scoop of fine grained fragmental material placed in one of the pre-numbered bags. [E, M] (HD)
- x. Photograph of each LM foot pad and surrounding lunar soil exhibiting evidence of LM foot pad - lunar soil interaction. [M] (HD)

## 2. Ground Support

- a. LM TM HBR. [E, L] (HD)
- b. Estimate of incident illumination. [D] (M)
- c. Video tape of all TV coverage. [L] (M)
- d. Record of S-band signal strength during TV transmission. [L] (M)
- e. GET at beginning and end of TV transmission. [L] (M)
- f. Time period when LBR TM was transmitted simultaneously with TV. [L] (M)
- g. Identity of ground station(s) used to record LM video transmission. [L] (M)
- h. Time period when erectable antenna was used to transmit from the lunar surface. [L] (M)

## EXPERIMENT DEPLOYMENT/CONDUCT

### A. Test Objectives

S-031 Deploy the Passive Seismic Experiment Package  
S-078 Deploy the Laser Ranging Retro-Reflector Experiment  
S-080 Conduct the Solar Wind Composition Experiment

### B. Test Requirements

1. Emplace, level and orient the Passive Seismic Experiment Package (PSEP).  
Deploy the solar panels and aim the antenna at the earth. [S-031 ]
2. Photograph the deployed PSEP and deployment area. [S-031]
3. Remove the Laser Ranging Retro-Reflector (LRRR) from the descent stage and carry it to the deployment site. [S-078]
4. Emplace, level and orient the LRRR to the alignment marks corresponding to the landing site. [S-078]
5. Remove the Solar Wind Composition Experiment from the LM MESA and deploy it on the lunar surface. [S-080]
6. After one hour operation, disassemble the Solar Wind Composition Experiment, place the reel and foil in a teflon bag and store in a sample return container. [S-080]

### C. Procedures/Checklist

None

### D. Data Requirements

1. Flight Crew Reports/Logs/Photographs
  - a. Comment on deployment of experiment. [S-031] (M)
  - b. Photograph deployment area. [S-031, S-078, S-080] (HD)
  - c. Comment on location of deployed experiment with respect to the LM, attitude of deployed foil with respect to the sun and total time foil was deployed. [S-080] (M)
  - d. Retrieve reel and foil from the Solar Wind Composition Experiment. [S-080] (M)
  - e. Comments on orientation and elevation setting used for deployment. [S-078] (HD)
2. Ground Support
  - a. Experiment TLM Data [S-031] (M)

## POST EVA OPERATIONS

### A. Test Objectives

B-1 Demonstrate Egress-to/Ingress-from the Lunar Surface  
C-1 EMU Capability to Provide a Habitable Environment  
C-2 EMU Effects on Crew Mobility, Dexterity/Comfort

### B. Test Requirements

1. Perform post EVA preparations and ingress. [B]
2. Perform PLSS shutdown. [C]

### C. Procedures/Checklist

1. EVA Procedures Document.

### D. Data Requirements

#### 1. Flight Crew Reports/Logs/Photographs

- a. Notify MSFN of the initial and final positions of the PLSS water diverter valve, primary oxygen shutoff valve and water shutoff/ relief valve each time they are changed. [C] (M)
- b. Notify MSFN when PLSS; High O2 flowrate, low vent flow, low feed water pressure or PGA pressure low remote control unit status indicators and audible warning tone come on. [C] (M)
- c. Provide data on the adequacy of hardware and procedures, and the time required to perform the ingress to the LM. [B] (M)
- d. Comment on the adequacy of procedures and difficulties encountered during doffing of EMU equipment. [C] (HD)
- e. Record quantity of water drained from PLSS at end of EVA period. [C] (M)
- f. Record EMU radiation dosimeter readings after completion of the EVA. [C] (M)
- g. Provide sequence camera coverage and TV camera coverage of a crew member ascending the LM ladder. [B] (M)

## CONTAMINATION PREVENTION

### A. Test Objectives

- I-1 Prevent Earth Contamination by Lunar Exposed Materials
- I-2 Minimize Crew/CM Contamination by Lunar Exposed Materials

### B. Test Requirements

- 1. All contamination related operations from the initial astronaut egress to the lunar surface until postflight crew/cm quarantine will be completed per procedures contained in the documents listed below. [I]

### C. Procedures/Checklist

- 1. Lunar Surface Operations Plan
- 2. EVA Procedures Document
- 3. Quarantine Procedures

### D. Data Requirements

- 1. Flight Crew Reports/Logs/Photographs
  - a. Crew comments on the adequacy of Biological Isolation Garment, sample return containers, Mobile Quarantine Facility and related equipment and procedures used to prevent back contamination. [I] (M)
  - b. Photograph boots, clothing and equipment showing adhesion of particles. [I, M] (HD)
- 2. Ground Support
  - a. Deliver samples, CM and Mobile Quarantine Facility to the Lunar Receiving Laboratory. [I] (M)
  - b. Comment on ground procedures and hardware used for retrieval, biological isolation and CM transfer to the Lunar Receiving Laboratory. [I] (M)
  - c. Report on the existence of contamination of the crew on CM. [I] (M)





SECTION V

**CONSUMABLES ANALYSIS**



NOTE

Acknowledgement is made to the Consumables Analysis Section (CAS) of the Mission Planning and Analysis Division (MPAD) for their work in the preparation of the consumable analysis presented herein and to the Crew Systems Division for the PLSS Consumables.



CSM-107/LM5 PROPELLANT BUDGET

The results of the Propellant Budget Analysis are summarized in the following Tables and Figures:

TABLE 5-1	SM RCS Propellant Loading And Usage Summary
TABLE 5-2	SM RCS Budget
TABLE 5-3	CM RCS Propellant Summary
TABLE 5-4	SPS Propellant Summary
TABLE 5-5	SPS Assumptions
TABLE 5-6	LM RCS Propellant Loading And Usage Summary
TABLE 5-7	LM RCS Budget
TABLE 5-8	DPS Propellant Summary
TABLE 5-9	DPS Assumptions
TABLE 5-10	APS Propellant Summary
TABLE 5-11	APS Assumptions
FIGURE 5-1	Total SM RCS Propellant Profile
FIGURE 5-2	Quad A SM RCS Propellant Profile
FIGURE 5-3	Quad B SM RCS Propellant Profile
FIGURE 5-4	Quad C SM RCS Propellant Profile
FIGURE 5-5	Quad D SM RCS Propellant Profile
FIGURE 5-6	Total LM RCS Propellant Profile

SM-RCS BUDGET  
GROUND RULES and ASSUMPTIONS

1. The transposition and docking phase of the mission includes an SPS evasive maneuver.
2. The first and third midcourse corrections (translunar) are executed as SPS burns with the third MCC followed by an RCS trim.
3. No SM RCS propellant is required during PTC or lunar orbit coast.
4. The sixth midcourse correction (transearth) is executed as an RCS burn of 5 fps.
5. The individual quad plots are included for reference only as quad management is determined by the flight controllers during the mission.

TABLE 5-1  
SM RCS PROPELLANT LOADING AND USAGE SUMMARY

Nominal loaded	1342.4 1b
Initial outage due to loaded mixture ratio	15.6
Total trapped	26.4
Gauging inaccuracy	<u>80.4</u>
Deliverable SM-RCS propellant	1220.0
Nominal usage	590
Translunar phase (through LOI-2)	204
Lunar orbit phase	311
Transearth phase (includes TEI)	75
Nominal remaining	630 1b

TABLE 5-2

SM-RCS PROPELLANT BUDGET					
TIME (HR)	EVENT	(a)		(b)	
		S/C WT (LBS)	S/C RCS USED (LBS)	S/C RCS LEFT (LBS)	S/C RCS LEFT (%)
.0	MISSION G	63457.	.0	1220.0	100.
.0	INITIALIZE PROP LOADING	63457.	.0	1220.0	100.
1.7	SM RCS CHECKOUT	63451.	5.8	1214.2	100.
3.2	TRANSPOSITION AND DOCKING +X 0.8 FPS	63445.	6.1	1208.1	99.
3.2	-X 0.3 FPS	63443.	2.4	1205.7	99.
3.2	PITCH TO ACQUIRE S-IVB PITCH 180 DEG AT 1.5 DEG/SEC	63440.	2.3	1203.4	99.
3.2	ROLL CSM 60 DEG 2 DEG/SEC	63439.	1.3	1202.1	99.
3.2	NULL RELATIVE DEL V 0.5 FPS	63435.	4.0	1198.1	98.
3.5	INDEX AND DOCK	63409.	26.0	1172.1	96.
4.2	LM EJECTION -X 5 SEC 4 JET	96717.	7.4	1164.6	95.
4.5	SPS BURN TO EVADE S-IVB ORIENT AT 0.2 DEG/SEC	96712.	4.4	1160.2	95.
4.5	ATTITUDE HOLD 0.5 DEG DB PGCS	96712.	.8	1159.4	95.
4.5	START TRANSIENT CONTROL	96710.	1.3	1158.1	95.
4.5	SPS BURN BUILD UP	96707.	.0	1158.1	95.
4.5	STEADY STATE BURN	96508.	.3	1157.8	95.
4.5	TAILOFF	96467.	.7	1157.2	95.
4.5	DAMP SHUTDOWN TRANSIENT	96466.	1.1	1156.1	95.
5.5	P52 IMU ALIGN	96466.	.2	1155.9	95.
5.9	NAVIGATION SIGHTINGS ORIENT AT 0.2 DEG/SEC	96461.	4.4	1151.5	94.

(a) Spacecraft weights are approximate and are included for reference only.  
(b) Note: These refer to usable SM RCS propellant.

TABLE 5-2 (CONT'D)

SM-RCS PROPELLANT BUDGET					
TIME (HR)	EVENT	S/C WT (LBS)	S/C RCS USED (LBS)	S/C RCS LEFT (LBS)	S/C RCS LEFT (%)
6.1	NAVIGATION SIGHTINGS ORIENT AT 0.2 DEG/SEC	96457.	4.4	1147.1	94.
7.0	ORIENT FOR PTC 3-AXIS 0.2 DEG/SEC	96453.	4.1	1143.0	94.
7.0	ATTITUDE HOLD 0.5 DEG DB PGNC	96452.	.8	1142.2	94.
7.0	ROLL 0.3 DEG/SEC	96451.	.4	1141.8	94.
10.6	TERMINATE PTC DAMP RATES	96447.	4.4	1137.4	93.
10.7	P52 IMU ALIGN	96447.	.2	1137.1	93.
11.5	MIDCOURSE CORRECTION NO 1 3-AXIS ORIENT PGNC	96442.	4.4	1132.7	93.
11.5	ATTITUDE HOLD 0.5 DEG DB PGNC	96442.	.8	1131.9	93.
11.5	START TRANSIENT CONTROL	96440.	1.3	1130.6	93.
11.5	SPS BURN BUILD UP	96437.	.0	1130.6	93.
11.5	STEADY STATE BURN 3 FPS PGNC	96402.	.1	1130.5	93.
11.5	TAILOFF	96361.	.8	1129.7	93.
11.5	DAMP SHUTDOWN TRANSIENT	96359.	1.1	1128.6	93.
12.0	P52 IMU ALIGN	96359.	.2	1128.4	92.
12.5	ORIENT FOR PTC 3-AXIS 0.2 DEG/SEC	96355.	4.1	1124.3	92.
12.5	ATTITUDE HOLD 0.5 DEG DB PGNC	96354.	.8	1123.5	92.
12.5	ROLL 0.3 DEG/SEC	96354.	.4	1123.1	92.
24.2	TERMINATE PTC DAMP RATES	96349.	4.4	1118.7	92.
24.3	P52 IMU ALIGN	96349.	.2	1118.5	92.



TABLE 5-2 (CONT'D)

SM-RCS PROPELLANT BUDGET					
TIME (HR)	EVENT	S/C WT (LBS)	S/C RCS USED (LBS)	S/C RCS LEFT (LBS)	S/C RCS LEFT (%)
24.5	CISLUNAR NAVIGATION STAR/EARTH HORIZON ORIENT	96345.	4.4	1114.2	91.
24.7	NAVIGATION SIGHTINGS ORIENT AT 0.2 DEG/SEC	96341.	4.4	1109.8	91.
26.6	MIDCOURSE CORRECTION NO 2 MNVR TO BURN ATT	96336.	4.4	1105.4	91.
26.6	ATTITUDE HOLD 0.5 DEG DB PGCS	96335.	.8	1104.7	91.
26.7	DELTA VEL = NOMINALLY ZERO	96335.	.0	1104.7	91.
27.0	ORIENT FOR PTC 3-AXIS 0.2 DEG/SEC	96331.	4.2	1100.5	90.
27.0	ATTITUDE HOLD 0.5 DEG DB PGCS	96330.	.8	1099.7	90.
27.0	ROLL 0.3 DEG/SEC	96330.	.4	1099.3	90.
52.8	TERMINATE PTC DAMP RATES	96326.	4.4	1094.9	90.
53.0	P52 IMU ALIGN	96325.	.2	1094.7	90.
53.6	MIDCOURSE CORRECTION NO 3 MNVR TO BURN ATT	96321.	4.4	1090.3	89.
53.6	ATTITUDE HOLD 0.5 DEG DB PGCS	96320.	.8	1089.5	89.
53.6	START TRANSIENT CONTROL	96319.	1.3	1088.2	89.
53.6	SPS BURN BUILD UP	96318.	.0	1088.2	89.
53.6	STEADY STATE BURN 3 FPS	96281.	.1	1088.1	89.
53.6	TAILOFF	96239.	.8	1087.3	89.
53.6	DAMP SHUTDOWN TRANSIENT	96238.	1.1	1086.2	89.
53.6	RCS TRIM 1 FPS	96227.	11.2	1075.0	88.
54.0	ORIENT FOR PTC 3-AXIS 0.2 DEG/SEC	96223.	4.1	1070.9	88.

TABLE 5-2 (CONT'D)

SM-RCS PROPELLANT BUDGET					
TIME (HR)	EVENT	S/C WT (LBS)	S/C RCS USED (LBS)	S/C RCS LEFT (LBS)	S/C RCS LEFT (%)
54.0	ATTITUDE HOLD 0.5 DEG DB PGCS	96222.	.8	1070.1	88.
54.0	ROLL 0.3 DEG/SEC	96222.	.4	1069.8	88.
69.5	TERMINATE PTC DAMP RATES	96217.	4.4	1065.3	87.
70.0	P52 IMU ALIGN	96217.	.2	1065.1	87.
70.5	MIDCOURSE CORRECTION NO 4 MNVR TO BURN ATT	96213.	4.4	1060.7	87.
70.5	ATTITUDE HOLD 0.5 DEG DB PGCS	96212.	.8	1059.9	87.
70.5	DELTA VEL = NOMINALLY ZERO	96212.	.0	1059.9	87.
72.7	P52 IMU ALIGN	96212.	.2	1059.7	87.
74.0	ORIENT AND SXT STAR CHECK	96207.	4.4	1055.2	86.
74.5	ORIENT AND OBSERVE LUNAR SURFACE	96203.	4.4	1050.8	86.
75.5	LUNAR ORBIT INSERTION BURN 1 3-AXIS ORIENT PGCS	96198.	4.4	1046.5	86.
75.5	ATTITUDE HOLD 0.5 DEG DB PGCS	96198.	.8	1045.7	86.
75.5	START TRANSIENT CONTROL	96196.	1.3	1044.4	86.
75.9	LOI BURN BUILD UP	96193.	.0	1044.4	86.
75.9	STEADY STATE BURN	72357.	.5	1043.9	86.
75.9	TAILOFF	72316.	.0	1043.9	86.
75.9	DAMP SHUTDOWN TRANSIENT	72315.	1.1	1042.8	85.
76.2	REV 1 ATTITUDE HOLD WIDE DEADBAND	72312.	3.0	1039.8	85.
77.5	P52 IMU ALIGN	72312.	.1	1039.6	85.

TABLE 5-2 (CONT'D)

SM-RCS PROPELLANT BUDGET					
TIME (HR)	EVENT	S/C WT (LBS)	S/C RCS USED (LBS)	S/C RCS LEFT (LBS)	S/C RCS LEFT (%)
78.2	REV 2 ATTITUDE HOLD	72309.	3.0	1036.6	85.
79.2	P52 IMU ALIGN	72309.	.1	1036.5	85.
80.0	LOI 2 LPO CIRC MNVR TO BURN ATT	72306.	3.5	1033.0	85.
80.0	ATTITUDE HOLD 0.5 DEG DB PGCS	72305.	.8	1032.2	85.
80.0	B-D ULLAGE	72290.	15.1	1017.1	83.
80.1	SPS BURN BUILD UP	72287.	.0	1017.1	83.
80.1	STEADY STATE BURN	71316.	.2	1017.0	83.
80.1	TAILOFF	71276.	.0	1017.0	83.
80.1	DAMP SHUTDOWN TRANSIENT	71275.	1.1	1015.9	83.
80.2	REV 3 ATTITUDE HOLD	71272.	3.0	1012.9	83.
80.4	REACQUIRE MSFN ROLL 0.2 DEG/SEC	71272.	.1	1012.8	83.
82.2	REV 4 ATTITUDE HOLD	71269.	3.0	1009.8	83.
82.3	MNVR TO LDG SITE OBS ATT	71265.	3.5	1006.3	82.
82.3	LDG SITE OBSERVATION	71265.	.4	1005.8	82.
82.3	REORIENT	71261.	3.5	1002.3	82.
82.3	REACQUIRE MSFN	71261.	.2	1002.1	82.
84.2	MANEUVER TO SLEEP ATTITUDE 3 AXIS 0.2 DEG/SEC	71258.	3.5	998.6	82.
94.4	DAMP RATES	71254.	3.5	995.0	82.
94.5	REACQUIRE MSFN	71254.	.1	994.9	82.

TABLE 5-2 (CONT'D)

SM-RCS PROPELLANT BUDGET					
TIME (HR)	EVENT	S/C WT (LBS)	S/C RCS USED (LBS)	S/C RCS LEFT (LBS)	S/C RCS LEFT (%)
95.1	MNVR TO ALIGN ATT	71250.	3.5	991.4	81.
96.2	REV 11 ATTITUDE HOLD	71247.	3.0	988.4	81.
98.2	REV 12 ATTITUDE HOLD	71244.	3.0	985.4	81.
98.5	MNVR TO LDG SITE OBS ATT	71241.	3.5	981.8	80.
98.5	LDG SITE OBSERVATION	71240.	.4	981.4	80.
98.9	REACQUIRE MSFN ROLL 0.2 DEG/SEC	71240.	.2	981.3	80.
99.8	MANEUVER TO AGS CAL ATTITUDE	71237.	3.5	977.7	80.
100.0	PRE UNDOCKING ALLOCATION	71213.	24.0	953.7	78.
100.0	ORIENT TO UNDOCKING ATTITUDE ROLL 0.2 DEG/SEC	71212.	.2	953.6	78.
100.2	CSM ACTIVE UNDOCK SEP AND NULL VEL 0.5 FPS	37893.	4.5	949.0	78.
100.2	FORMATION FLYING	37883.	10.0	939.0	77.
100.2	REACQUIRE MSFN	37883.	.1	938.9	77.
100.6	ORIENT FOR SEP BURN	37880.	3.1	935.8	77.
100.7	RCS SEPARTATION BURN 2.5 FPS	37868.	11.2	924.6	76.
100.7	REV 13 ATTITUDE HOLD	37865.	3.0	921.6	76.
101.5	MANEUVER TO SXT TRACKING	37862.	3.1	918.6	75.
102.6	MANEUVER TO SXT TRACKING	37859.	3.1	915.5	75.
104.4	REACQUIRE MSFN ROLL 0.5 DEG/SEC	37859.	.3	915.5	75.
104.5	MANEUVER TO SXT TRACKING	37856.	3.1	912.2	75.

TABLE 5-2 (CONT'D)

SM-RCS PROPELLANT BUDGET					
TIME (HR)	EVENT	S/C WT (LBS)	S/C RCS USED (LBS)	S/C RCS LEFT (LBS)	S/C RCS LEFT (%)
104.6	REV 14 ATTITUDE HOLD	37853.	3.0	909.2	75.
104.6	MNVR TO LDG SITE OBS ATT	37850.	3.1	906.1	74.
104.6	SDG SITE OBS	37850.	.4	905.7	74.
104.7	TRACK LM	37846.	3.1	902.6	74.
104.9	REACQUIRE MSFN ROLL 0.5 DEG/SEC	37846.	.3	902.3	74.
105.0	REV 15 ATTITUDE HOLD	37843.	3.0	899.3	74.
105.0	REACQUIRE MSFN ROLL 0.5 DEG/SEC	37843.	.3	899.1	74.
107.0	PLANE CHANGE MNVR TO BURN ATT	37840.	3.1	896.0	73.
107.0	ATTITUDE HOLD 0.5 DEG DB PGCS	37839.	.8	895.2	73.
107.0	ULLAGE	37825.	14.3	880.9	72.
107.0	SPS BURN BUILD UP	37822.	.0	880.9	72.
107.0	STEADY STATE	37754.	.1	880.8	72.
107.0	TAILOFF	37713.	1.0	879.8	72.
107.0	DAMP SHUTDOWN TRANSIENT	37712.	1.1	878.7	72.
107.2	P52 IMU ALIGN	37712.	.1	878.6	72.
107.2	MANEUVER TO SLEEP ATTITUDE	37710.	1.7	876.9	72.
111.5	DAMP RATES	37707.	3.1	873.9	72.
112.2	REV 19 ATTITUDE HOLD	37704.	3.0	870.9	71.
114.2	REV 20 ATTITUDE HOLD	37701.	3.0	867.9	71.

TABLE 5-2 (CONT'D)

SM-RCS PROPELLANT BUDGET					
TIME (HR)	EVENT	S/C WT (LBS)	S/C RCS USED (LBS)	S/C RCS LEFT (LBS)	S/C RCS LEFT (%)
114.3	ORIENT FOR SEXTANT TRACKING	37698.	3.1	864.8	71.
115.0	MANEUVER TO SLEEP ATT	37697.	.7	864.1	71.
120.0	DAMP RATES	37697.	.7	863.5	71.
120.0	SEXTANT TRACKING	37695.	1.3	862.2	71.
120.0	REACQUIRE MSFN	37695.	.1	862.1	71.
120.2	REV 23 ATTITUDE HOLD	37692.	3.0	859.1	70.
122.2	REV 24 ATTITUDE HOLD NARROW DEADBAND	37687.	5.2	853.9	70.
124.5	SUPPORT LM LIFT OFF	37669.	18.0	835.9	69.
124.6	MANEUVER TO TRACK LM POST LIFTOFF	37666.	3.1	832.8	68.
125.5	MANEUVER TO SUPPORT LM CSI BURN	37663.	3.1	829.7	68.
125.6	MANEUVER TO TRACK LM POLST CSI	37660.	3.1	826.6	68.
125.6	REV 25 ATTITUDE HOLD NARROW DEADBAND	37654.	5.2	821.4	67.
126.5	MANEUVER TO SUPPORT LM CDH BURN	37651.	3.0	818.4	67.
126.6	MANEUVER TO TRACK LM POST CDH	37648.	3.1	815.3	67.
126.6	RNDZ NAV	37645.	3.1	812.2	67.
126.6	REINITIATE RNDZ NAV	37642.	3.1	809.1	66.
127.0	MANEUVER TO SUPPORT LM TPI BURN	37639.	3.1	806.1	66.
127.1	MANEUVER TO TRACK LM POST TPI	37636.	3.1	803.0	66.
127.1	MANEUVER TO COAS TRACK	37633.	3.1	799.9	66.

TABLE 5-2 (CONT'D)

SM-RCS PROPELLANT BUDGET					
TIME (HR)	EVENT	S/C WT (LBS)	S/C RCS USED (LBS)	S/C RCS LEFT (LBS)	S/C RCS LEFT (%)
127.1	MANEUVER TO SXT TRACKING	37630.	3.1	796.9	65.
127.2	MANEUVER TO SUPPORT LM MCC1 BURN	37627.	3.1	793.8	65.
127.2	MANEUVER TO SXT TRACKING	37624.	3.1	790.8	65.
127.5	MANEUVER TO SUPPORT LM MCC2 BURN	37621.	3.1	787.7	65.
127.5	MANEUVER TO SUPPORT LM TPF BURN	37618.	3.0	784.7	64.
127.5	MANEUVER TO SXT TRACKING	37615.	3.1	781.6	64.
127.8	ORIENT TO DOCKING ATTITUDE	37612.	3.1	778.5	64.
127.8	ALLOCATION FOR TERMINAL RDZ USAGE FROM POSTFLIGHT	37577.	35.0	743.5	61.
127.9	MAINTAIN BORESIGHT	37574.	3.1	740.5	61.
128.0	DOCKING	43212.	26.0	714.5	59.
131.5	MNVR TO JETTISON ATT	43210.	1.1	713.3	58.
132.0	JETTISON LM 1 FPS	37542.	4.7	708.6	58.
132.0	ORIENT TO TRACKING ATT	37540.	1.6	707.0	58.
132.0	TRACK LM	37540.	.4	706.6	58.
132.6	HOLD INERTIAL ATT	37539.	.4	706.1	58.
132.6	P52 IMU ALIGN	37539.	.7	705.5	58.
134.5	P52 IMU ALIGN	37538.	.7	704.8	58.
134.5	SXT STAR CHECK	37537.	.4	704.4	58.
135.0	TRANS-EARTH INJECTION MNVR TO BURN ATT	37536.	1.6	702.7	58.

TABLE 5-2 (CONT'D)

SM-RCS PROPELLANT BUDGET					
TIME (HR)	EVENT	S/C WT (LBS)	S/C RCS USED (LBS)	S/C RCS LEFT (LBS)	S/C RCS LEFT (%)
135.0	ATTITUDE HOLD 0.5 DEG DB PGCS	37535.	.8	702.0	58.
135.0	ULLAGE	37521.	14.3	687.6	56.
135.5	SPS BURN BUILD UP	37518.	.0	687.6	56.
135.5	STEADY STATE SPS BURN	27478.	.2	687.4	56.
135.5	TAILOFF	27437.	.0	687.4	56.
135.5	DAMP SHUTDOWN TRANSIENT	27436.	1.1	686.3	56.
136.0	P52 IMU ALIGN	27436.	.6	685.7	56.
136.0	ORIENT FOR PTC	27435.	1.1	684.6	56.
136.0	ATTITUDE HOLD 0.5 DEG DB PGCS	27434.	.8	683.8	56.
136.0	ROLL 0.3 DEG/SEC	27434.	.1	683.7	56.
147.5	TERMINATE PTC DAMP RATES	27432.	1.3	682.3	56.
147.6	P52 IMU ALIGN	27432.	.6	681.8	56.
150.0	MIDCOURSE CORRECTION NO 5 MANVR TO BURN ATT	27430.	1.3	680.5	56.
150.0	ATTITUDE HOLD 0.5 DEG DB PGCS	27430.	.8	679.7	56.
150.0	DEL VEL = NOM ZERO	27430.	.0	679.7	56.
150.5	ORIENT FOR PTC	27428.	1.1	678.5	56.
150.5	ATTITUDE HOLD 0.5 DEG DB PGCS	27428.	.8	677.8	56.
150.5	ROLL 0.3 DEG/SEC	27428.	.1	677.6	56.
171.0	TERMINATE PTC	27426.	1.3	676.3	55.



TABLE 5-2 (CONT'D)

SM-RCS PROPELLANT BUDGET					
TIME (HR)	EVENT	S/C WT (LBS)	S/C RCS USED (LBS)	S/C RCS LEFT (LBS)	S/C RCS LEFT (%)
172.0	P52 IMU ALIGN	27426.	.6	675.8	55.
172.5	MIDCOURSE CORRECTION NO & MANVR TO BURN ATT	27424.	1.3	674.5	55.
172.5	ATTITUDE HOLD 0.5 DEG DB PGCS	27424.	.8	673.7	55.
172.5	RCS -X TRANS 5 FPS	27408.	15.9	657.8	54.
173.0	ORIENT FOR PTC	27407.	1.1	656.6	54.
173.0	ATTITUDE HOLD 0.5 DEG DB PGCS	27406.	.8	655.8	54.
173.0	ROLL 0.3 DEG/SEC	27406.	.1	655.7	54.
190.0	TERMINATE PTC	27404.	1.3	654.4	54.
191.2	P52 IMU ALIGN	27404.	.6	653.8	54.
192.0	MIDCOURSE CORRECTION NO 7 MNVR TO BURN ATT	27402.	1.3	652.5	53.
192.0	ATTITUDE HOLD 0.5 DEG DB PGCS	27402.	.8	651.7	53.
192.0	DEL VEL = NOM ZERO	27402.	.0	651.7	53.
192.0	STAR CHECK MIN IMPULSE	27401.	.4	651.3	53.
193.0	MANEUVER TO REENTRY ATTITUDE	27399.	2.6	648.7	53.
193.0	ATTITUDE HOLD 0.5 DEG DB PGCS	27390.	8.6	640.1	52.
194.8	MANEUVER TO SEP ATTITUDE	27387.	2.6	637.4	52.
194.8	CM/SM SEPARATION DELTA VEL = 3 FPS	15001.	7.9	629.6	52.

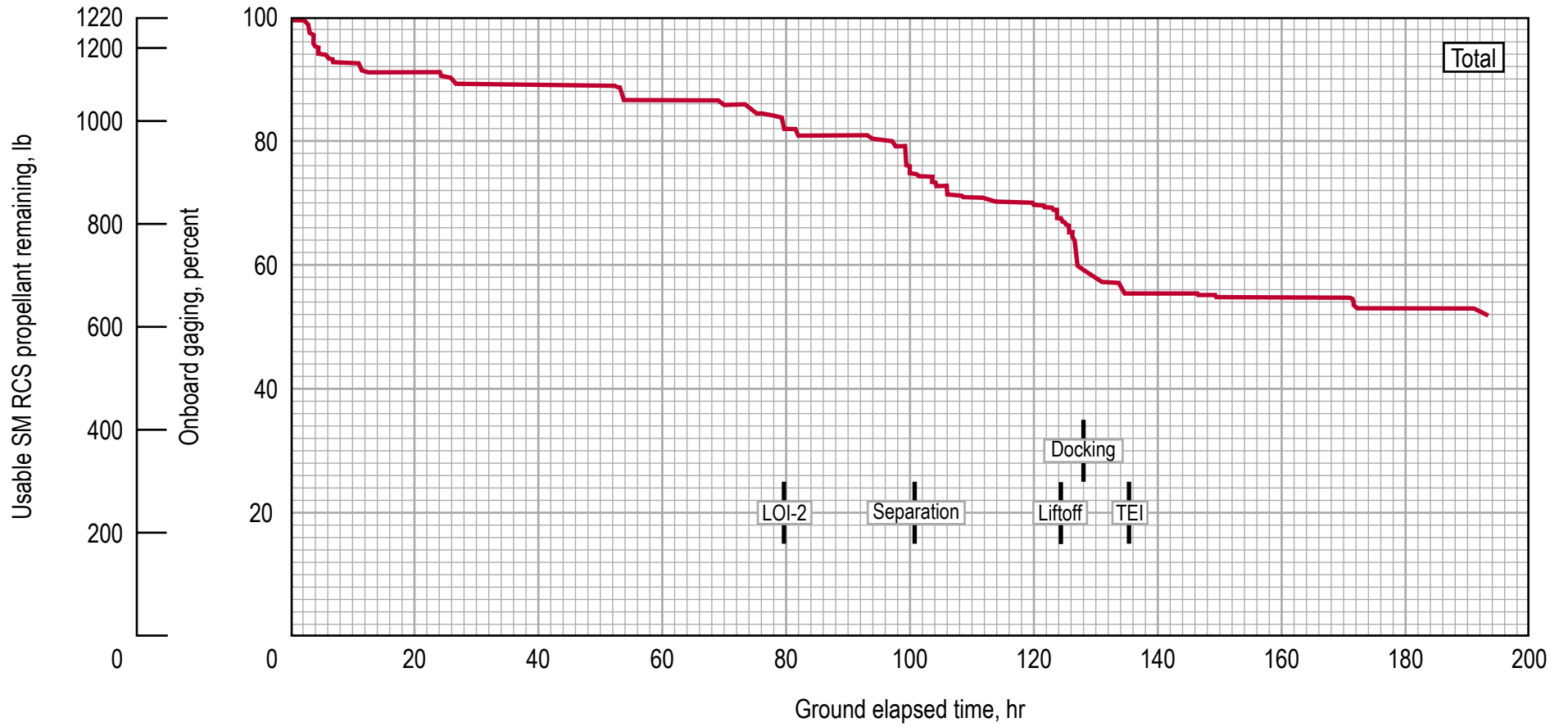

Figure 5-1  
SM RCS propellant profile - total

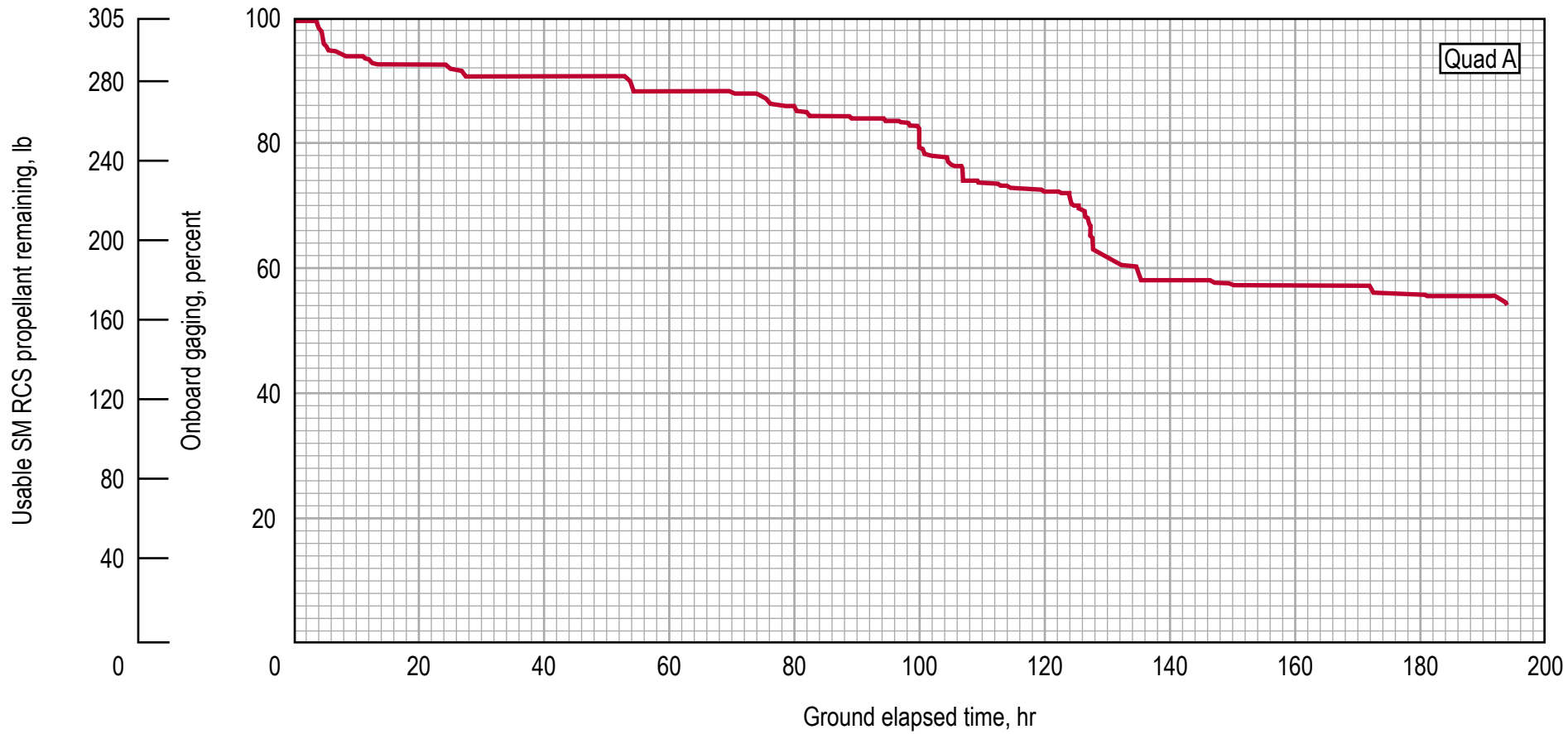

Figure 5-2  
SM RCS propellant profile - quad A

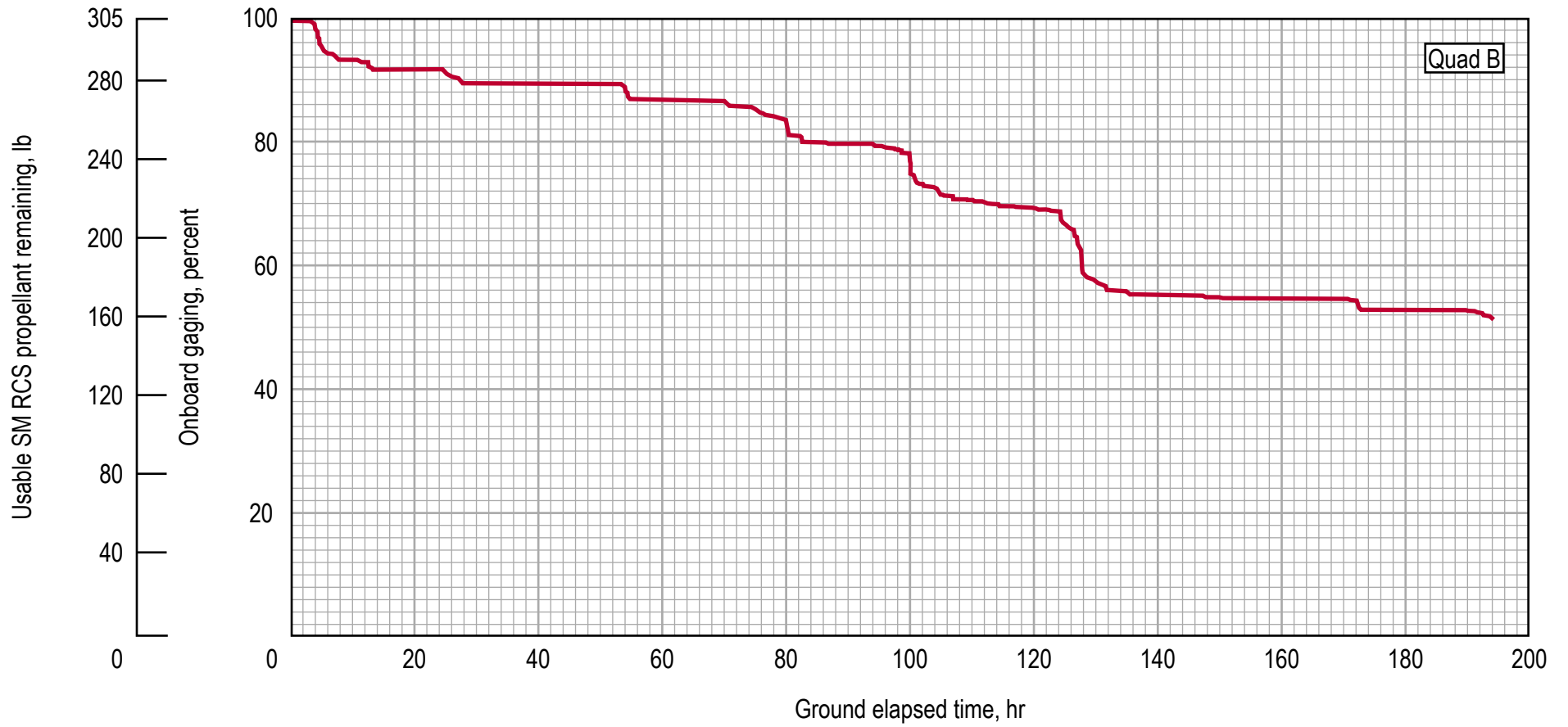

Figure 5-3  
SM RCS propellant profile - quad B

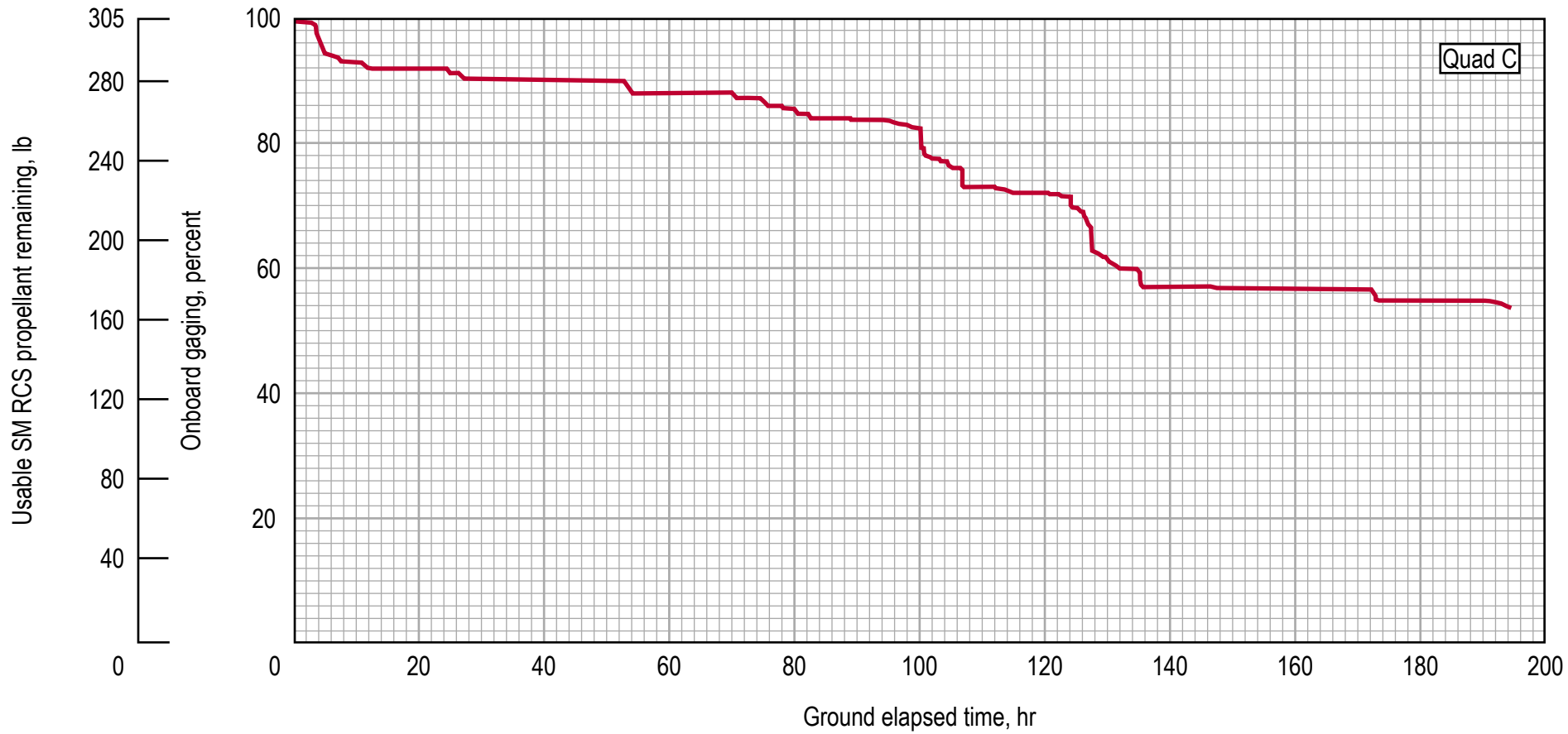

Figure 5-4  
SM RCS propellant profile - quad C

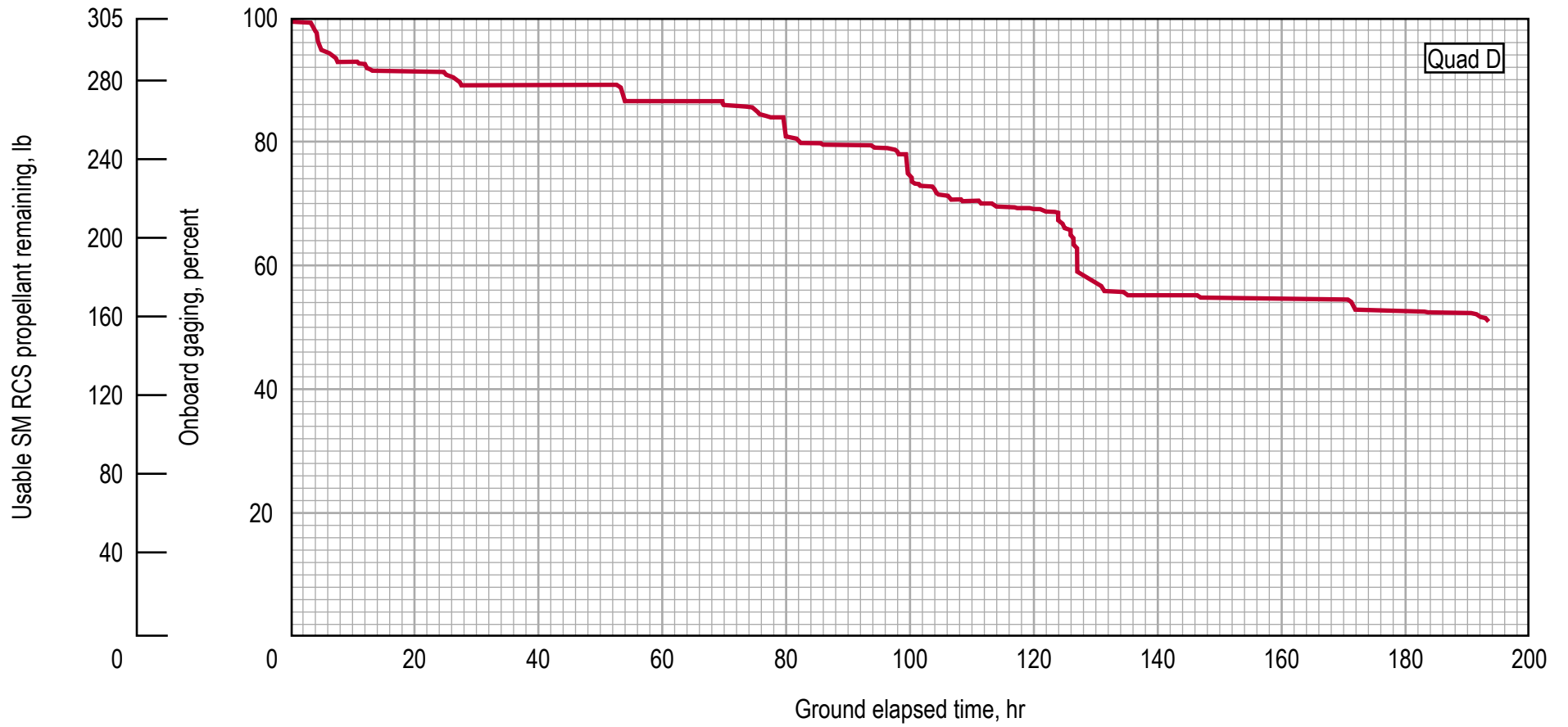

Figure 5-5  
SM RCS propellant profile - quad D

TABLE 5-3  
CM RCS Propellant Summary

<u>Item</u>	<u>Propellant required, lb.</u>	<u>Propellant remaining, lb.</u>
Loaded	--	245.0
Trapped	36.4	208.6
Available for mission planning	--	208.6
Nominal usage	39.3	169.3
Nominal remaining	--	169.3

SERVICE PROPULSION SYSTEM

SERVICE PROPULSION SYSTEM (SPS). - The budget presented in table 5-4 is for a July 16 launch, 72 degree launch azimuth, first opportunity injection, 59.5 hour lunar parking orbit, and fast earth return. The assumptions used in preparing this budget are presented in table 5-5.  $\Delta V$  requirements were coordinated with LMAB in MPAD.

It should be noted that the mission flexibility allowance of 900 fps has been used in addition to the fast return. In real time however, it is highly likely that a slower earth return would be performed in the mission flexibility  $\Delta V$  had already been used (e.g., for LM rescue). Table 5-4 shows 3906 lbs of propellant remaining nominally and a total propellant margin (accounting both for the flexibility  $\Delta V$  and the fast return) of 1268 lb.

Table 5-4 - APOLLO 11 SPS PROPELLANT SUMMARY

<u>ITEM</u>	<u>PROPELLANT REQUIRED, LB</u>	<u>PROPELLANT REMAINING, LB</u>
Loaded <sup>a</sup>	--	40803.0
Trapped and unavailable	441.4	40361.6
Outage	59.5	40302.1
Unbalance meter	100.0	40202.1
Available for $\Delta V$	--	40202.1
Required for $\Delta V$		
TLMC (120 fps) <sup>b</sup>	1166.4	39035.7
LOI-1 (2924 fps, 5 min. 59 sec.)	23862.4	15173.3
LOI-2 (157.8 fps, 16.4 sec.)	1115.4	14057.9
LOPC (16.6 fps, .9 sec.)	73.8	13984.1
TEI (3292.7 fps, 149 sec.)	10077.8	3906.3
Nominal remaining	--	3906.3
Mission flexibility (900 fps)	2212.4	1693.9
Dispersions (-3 $\sigma$ )	426.0	1267.9
Propellant margin	--	1267.9

<sup>a</sup> 15712.0 lb of fuel and 25091.0 lb of oxidizer; this is loaded on CSM-107.

<sup>b</sup> Includes 19.7 fps for evasive maneuver.



TABLE 5-5 - ASSUMPTIONS FOR THE APOLLO 11 SPS PROPELLANT BUDGET

1. There is a non-propulsive propellant loss of 14.4 lb for each engine start. LM rescue assumed three engine starts.
2. A mission flexibility  $\Delta V$  of 900 fps has been included in the SPS budget to provide the capability to perform a worst case LM rescue, or to handle several other contingencies (such as loss of PGNCs), or to perform a quicker earth return.

3. Spacecraft weight:

CM	12 280.0 lb
SM	10 551.3 lb
SLA Ring	98.0 lb
Tanked SPS	40 600.7 lb
LM (unmanned)	33 278.3 lb
Total	<u>96 808.3 lb</u>

4. Lunar Orbit Activity

Total weight transfer (CSM to LM) = 436.7 lb  
 Total weight transfer (LM to CSM) = 284.0 lb

5. SM RCS, EPS and ECS weight losses:

<u>Mission Period</u>	<u>Incremental Weight Loss, lb</u>
EL to TLMC	151.8
TLMC to LOI-1	327.1
LOI-1 to LOI-2	32.0
LOI-2 to LOPC	146.5
LOPC to TEI	216.1

6. SM RCS usage (above nominal rendezvous requirement) for LM rescue was 216 lb.

## LM RCS BUDGET

### Ground Rules and Assumptions

1. Data for the LM RCS engine performance and propellant requirements were obtained from the Spacecraft Operational Data Book and postflight analysis from Apollo 9 and Apollo 10.
2. All orientation maneuvers were assumed to be made at 2.0°/sec.
3. All orientation maneuvers were assumed to be three-axis maneuvers.

TABLE 5-6

### LM RCS Propellant Loading and Usage Summary

Loaded	633.0
Trapped	40.6
Nominal deliverable	592.4
Gaging inaccuracy and loading tolerance	39.5
Mixture ratio uncertainty	17.0
Usable	535.9
Nominal mission requirement	252.7
Nominal remaining	283.2

TABLE 5-7

LM-RCS PROPELLANT BUDGET					
TIME (HR)	EVENT	(a)		(b)	
		S/C WT (LBS)	S/C RCS USED (LBS)	S/C RCS LEFT (LBS)	S/C RCS LEFT (%)
0 00	OUTPUT PROPELLANT LOADINGS	33714.	.0	633.0	100.
99 25	RCS HOT FIRE	33709.	5.0	628.0	99.2
100 15	UNDOCKING	33709.	.0	628.0	99.2
100 15	NULL UNDOCKING VELOCITY	33707.	1.9	626.1	98.9
100 20	LM MNVR FOR INSPECTION YAW	33705.	1.7	624.4	98.6
100 20	LM MNVR FOR INSPECTION PITCH	33703.	2.0	622.4	98.3
100 25	LM MNVR FOR INSPECTION YAW	33702.	.8	621.6	98.2
100 25	FORMATION FLYING	33690.	2.0	619.6	97.9
100 50	RR LOCK ON MNVR	33687.	3.6	616.0	97.3
101 00	IMU REALIGN STAR 1	33683.	3.6	612.4	96.7
101 00	IMU REALIGN STAR 2	33680.	3.6	608.8	96.2
101 00	IMU REALIGN STAR 3	33676.	3.6	605.2	95.6
101 32	MNVR TO DOI BURN ATTITUDE	33672.	3.6	601.6	95.0
101 32	ATTITUDE HOLD	33672.	.1	601.5	95.0
101 38	2 JET ULLAGE	33667.	5.9	595.6	94.1
101 38	DOI BURN	33419.	.0	595.6	94.1
101 38	MOMENT CONTROL DOI BURN	33414.	5.0	590.6	93.3
101 38	TRIM HORIZONTAL RESIDUAL	33407.	7.6	583.0	92.1
101 38	ATTITUDE HOLD	33407.	.3	582.8	92.1
101 38	PITCH DOWN	33406.	1.0	581.8	91.9
101 42	RR LOCK ON MNVR	33402.	3.6	578.2	91.3
101 55	PITCH DOWN	33401.	.6	577.6	91.3
101 55	YAW LEFT	33401.	.6	577.0	91.2
102 00	ALIGNMENT CHECK	33400.	1.2	575.8	91.0
102 10	RR LOCK ON MNVR	33396.	3.6	572.2	90.4
102 14	MNVR TO PDI ATTITUDE	33392.	3.6	568.6	89.8
102 14	MAINTAIN LOS	33391.	1.0	567.6	89.7
102 29	ATTITUDE HOLD	33391.	.1	567.5	89.7
102 35	2 JET ULLAGE	33385.	5.9	561.7	88.7
102 35	PDI BURN	16753.	.0	561.7	88.7
102 35	POWERED DESCENT	16710.	34.1	527.5	83.3
102 47	TOUCHDOWN	16710.	.0	527.5	83.3

<sup>a</sup> These weights were used for analysis only and do not reflect the actual weight after consumables loading.

<sup>b</sup> RCS propellant remaining of total loaded.

TABLE 5-7 (CONT'D)

LM-RCS PROPELLANT BUDGET					
TIME (HR)	EVENT	(a)		(b)	
		S/C WT (LBS)	S/C RCS USED (LBS)	S/C RCS LEFT (LBS)	S/C RCS LEFT (%)
112 40	ADD LUNAR SAMPLES	16580.	.0	527.5	83.3
124 23	LUNAR LIFT OFF	10840.	.0	527.5	83.3
124 23	POWERED ASCENT PHASE WITH RCS/APS INTERCONNECT	6087.	.0	527.5	83.3
124 23	POWERED ASCENT PHASE WITHOUT RCS/APS INTERCONNECT	5969.	.9	526.7	83.2
124 25	RR LOCK ON MNVR	5969.	.4	526.2	83.1
124 30	INSERTION BURN CONTROL	5967.	1.8	524.4	82.8
124 30	TRIM OUT OF PLANE ERROR	5964.	3.3	521.2	82.3
124 30	ATTITUDE HOLD	5962.	1.3	519.9	82.1
124 37	IMU REALIHN STAR 1	5962.	.4	519.5	82.1
124 37	IMU REALIHN STAR 2	5961.	.4	519.0	82.0
124 37	IMU REALIHN STAR 3	5961.	.4	518.6	81.9
124 55	RR LOCK ON MNVR	5961.	.4	518.1	81.9
124 55	MAINTAIN LOS	5958.	2.7	515.5	81.4
125 15	ATTITUDE HOLD	5957.	1.3	514.2	81.2
125 21	CSI BURN RCS +2	5923.	33.6	480.6	75.9
125 26	MAINTAIN LOS	5920.	3.3	477.2	75.4
125 44	MNVR TO PLANE CHANGE ATTITUDE	5919.	.4	476.8	75.3
125 45	ATTITUDE HOLD	5918.	1.3	475.5	75.1
125 50	RCS PLANE CHANGE BURN	5914.	4.1	471.4	74.5
126 00	RR LOCK ON MNVR	5913.	.4	471.0	74.4
126 00	MAINTAIN LOS	5911.	2.0	469.0	74.1
126 15	ATTITUDE HOLD	5910.	1.3	467.7	73.9
126 19	CDH RCS BURN	5906.	4.0	463.7	73.3
126 19	MAINTAIN LOS	5902.	4.0	459.7	72.6
126 53	ATTITUDE HOLD	5901.	1.3	458.4	72.4
126 58	RCS TPI BURN	5884.	17.0	441.4	69.7
126 58	MAINTIN LOS	5883.	1.3	440.1	69.5
127 36	MCC AND BRAKING	5849.	33.9	406.3	64.2
127 36	ATTITUDE AND LOS CONTROL	5833.	16.0	390.3	61.7
128 00	LM CONTROL CSM ACTIVE DOCKING	5823.	10.0	380.3	60.1

<sup>a</sup> These weights were used for analysis only and do not reflect the actual weight after consumables loading.

<sup>b</sup> RCS propellant remaining of total loaded.

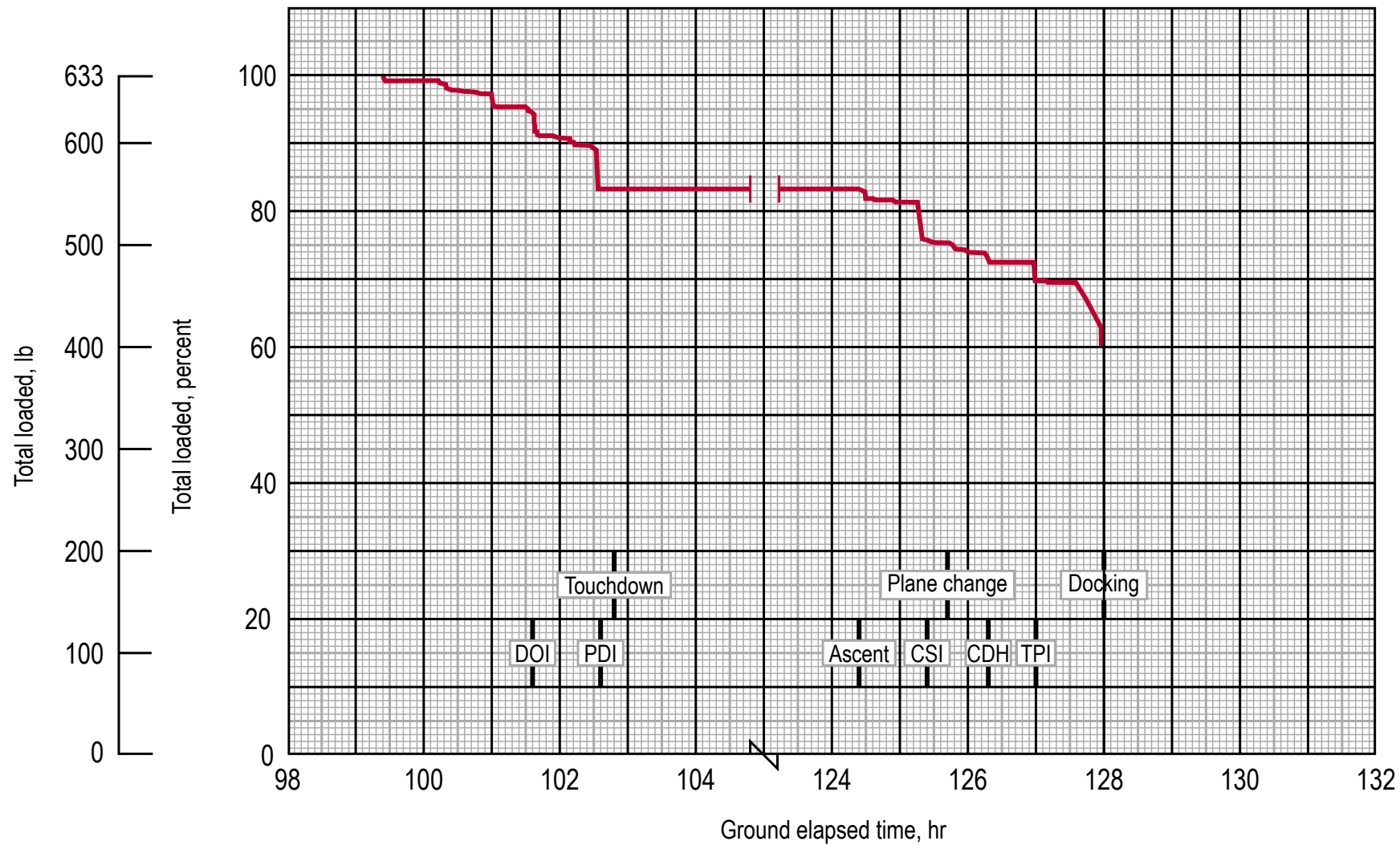

Figure 5-6  
LM RCS propellant profile

DESCENT PROPULSION SYSTEM PROPELLANT BUDGET

DESCENT PROPULSION SUBSYSTEM (DPS) - The DPS budget is shown in table 5-8 and the ground rules and assumptions in table 5-9.

Previously, the uncertainty in the low-level sensor (68.7 lb) has been shown as a contingency allowance. This is now included as part of the unusables. Also, there has previously been a contingency allowance for manual hover to allow for 2 minutes of burn time from 500 feet to touchdown. The present budget shows a nominal  $\Delta V$  which includes a manual allowance of 477 fps (90 sec) from 500 feet to touchdown. Any additional hover time will be used from the propellant margin (unassigned capability). The rate of use for hover is approximately 9.1 lb/sec.

Propellant loads are those actually loaded on LM-5, and trapped and residual propellants are from Volume III, SODB. Engine performance data and  $\Delta V$  requirements have been coordinated with LAB in MPAD.

Three sigma dispersions represent total propellant cost due to 3 s uncertainties in propellant loading, trapped,  $I_{sp}$ ,  $\Delta V$ , separation weight, non- $\Delta V$  consumables weight, and mixture ratio. There is a total propellant margin of 669 lb or approximately 73 seconds of hover time.

Table 5-8 - APOLLO 11 DPS PROPELLANT SUMMARY

<u>ITEM</u>	<u>PROPELLANT REQUIRED, LB</u>	<u>PROPELLANT REMAINING, LB</u>
Loaded <sup>a</sup>	--	18184.2
Trapped and unavailable	223.5	17960.7
Outage	14.0	17946.7
Low-Level Sensor Uncertainty	68.7	17878.0
Available for $\Delta V$	--	17878.0
Nominal Required for $\Delta V$ of 6728.6 fps	16799.7	1078.3
Dispersions (-3 $\sigma$ )	224.7	853.6
Contingencies		
Engine Valve-Pair Malfunction ( $\Delta MR = \pm 0.016$ )	81.1	772.5
Redesignation (60 fps)	104.0	668.5
Margin (73 sec. hover)	--	668.5

<sup>a</sup> 6974.8 lb of fuel and 11209.4 lb of oxidizer; this is loaded on the LM-5 spacecraft.

Table 5-9 - ASSUMPTIONS FOR THE APOLLO 11 DPS PROPELLANT BUDGET

1. Integrated average  $I_{sp} = 301.9 \pm 3.54$  seconds
2. LM separation weight = 33746. lb
3. Mixture ratio =  $1.596 \pm 0.0108$
4. Nominal  $\Delta V = 6728.6 \pm 96$  fps
5. Non- $\Delta V$  consumables of 47.4 lb from separation to DOI and 106.1 lb from DOI to touchdown.

ASCENT PROPULSION SYSTEM PROPELLANT BUDGET

ASCENT PROPULSION SUBSYSTEM (APS) - Tables 5-10 and 5-11 present the ascent propellant budget for the current mission. Propellant loads are those actually on LM-5. Mission  $\Delta V$  was coordinated with LAB in MPAD. The budget shown in table 5-10 accounts for an engine valve-pair malfunction, a PGNCs to AGS switchover, and a touchdown abort. There is a total propellant margin of 68 lb or about 6 seconds of burn time.

Table 5-10 - APOLLO 11 APS PROPELLANT SUMMARY

<u>ITEM</u>	<u>PROPELLANT REQUIRED, LB</u>	<u>PROPELLANT REMAINING, LB</u>
Loaded <sup>a</sup>	--	5238.4
Trapped and unavailable	48.9	5189.5
Outage	17.5	5172.0
Available for $\Delta V$	--	5172.0
Nominal Required for $\Delta V$ of 6072.5 fps	4965.8	206.2
Dispersions ( $-3 \sigma$ )	57.8	148.4
Contingencies		
Engine Valve-Pair Malfunction ( $\Delta MR = \pm 0.016$ )	19.6	128.8
PGNCs to AGS Switchover (40 fps)	23.8	105.0
Touchdown Abort ( $\Delta W = +99.9$ lb, $\Delta \Delta V = -15$ fps)	36.8	68.2
Margin (6 seconds)	--	68.2

<sup>a</sup> Includes 2019.9 lb fuel and 3218.5 lb oxidizer; this is loaded on the LM-5 spacecraft.

Table 5-11 - ASSUMPTIONS FOR THE APOLLO 11 APS PROPELLANT BUDGET

1.  $I_{sp} = 308.97 \pm 3.553$  seconds
2. Mixture ratio =  $1.602 \pm 0.0225$
3. Nominal  $\Delta V = 6072.5 \pm 33.5$  fps
4. Ascent stage lift-of weight = 10873.6 lb

CSM-107/LM5 CRYOGENIC/EPS AND ECS BUDGET

The results of the Cryogenic, EPS, and ECS analysis are summarized in the following tables and figures:

TABLE 5-11	CSM Cryogenic Loading And Usage Summary
TABLE 5-13	LM EPS Summary
TABLE 5-14	LM ECS Summary
FIGURE 5-7	CSM O2 PROFILE
FIGURE 5-8	CSM H2 PROFILE
FIGURE 5-9	CSM POWER PROFILE
FIGURE 5-10	CSM BUS VOLTAGE VS TIME
FIGURE 5-11	LM DESCENT POWER PROFILE
FIGURE 5-12	LM ASCENT POWER PROFILE
FIGURE 5-13	LM TOTAL CURRENT PROFILE
FIGURE 5-14	LM DESCENT O2 PROFILE
FIGURE 5-15	LM ASCENT O2 PROFILE
FIGURE 5-16	LM DESCENT H2O PROFILE
FIGURE 5-17	LM ASCENT H2O PROFILE

CSM EPS BUDGET

ASSUMPTIONS AND GROUND RULES

1. The system was assumed to operate with three fuel cells and two inverters.
2. Fuel cell purging is included in the EPS requirements.
3. 100% fill for both H<sub>2</sub> and O<sub>2</sub>.
4. Three entry and postlanding batteries were considered available to supply the total spacecraft power required for entry, parachute descent, and postlanding time. Each battery was assumed to have a 40 A-h capacity until splashdown, at which time the capacity was uprated to 45 A-h.
5. Two batteries were considered to be in parallel with the fuel cells during ascent and for each SPS maneuver.
6. No cryogenic venting was assumed in flight.
7. The EPS hydrogen consumption rate (lb/hr) =  $0.00257 \times I_{fc}$
8. The EPS oxygen consumption rate (lb/hr) =  $7.936 \times \dot{H}_2$
9. Six battery charges were assumed: three on battery A and three on battery B.



TABLE 5-12  
APOLLO 11 CRYOGENIC SUMMARY

	H <sub>2</sub> , lb	O <sub>2</sub> , lb
I. Planning Allowance		
A. Total Loaded	58.60	660.20
B. Less Residual	2.32	13.00
C. Less Instrumentation Error	1.50	17.50
Available for Mission Planning	54.78	629.70
II. Predicted Usages		
A. Prelaunch <sup>1</sup>		
1. Inline HTR + Pressure Relief (T-28 to T-3 (Incl 12.5 hr hold ))	1.61	18.60
2. Power Production (plus ECS O <sub>2</sub> ) (T-3 to liftoff)	.57	6.96
Total Prelaunch requirements	2.18	25.50
B. Flight		
1. EPS Requirements (Incl FC Purge)	36.60	288.33
2. CM ECS (Incl Cabin Purge)	-	72.40
3. LM Pressurizations	-	10.35
Total Flight Requirements	36.60	371.08
III. Nominal Reserves (RSS)		
EPS Uncertainty (5 percent)	1.83	14.42
ECS Uncertainty (.08 lb/hr)	-	15.60
Tank Unbalance (AOH)	.80	12.90
Launch Window	.86	10.20
RSS Subtotal	2.17	26.87
IV. Operational Reserves		
A. Available for Mission Planning	54.78	629.70
B. Less Nominal Predicted Usage	38.78	396.58
C. Less Nominal Reserves	2.17	26.87
Operational Reserve	13.83	206.25

<sup>1</sup> KSC Supplied Data

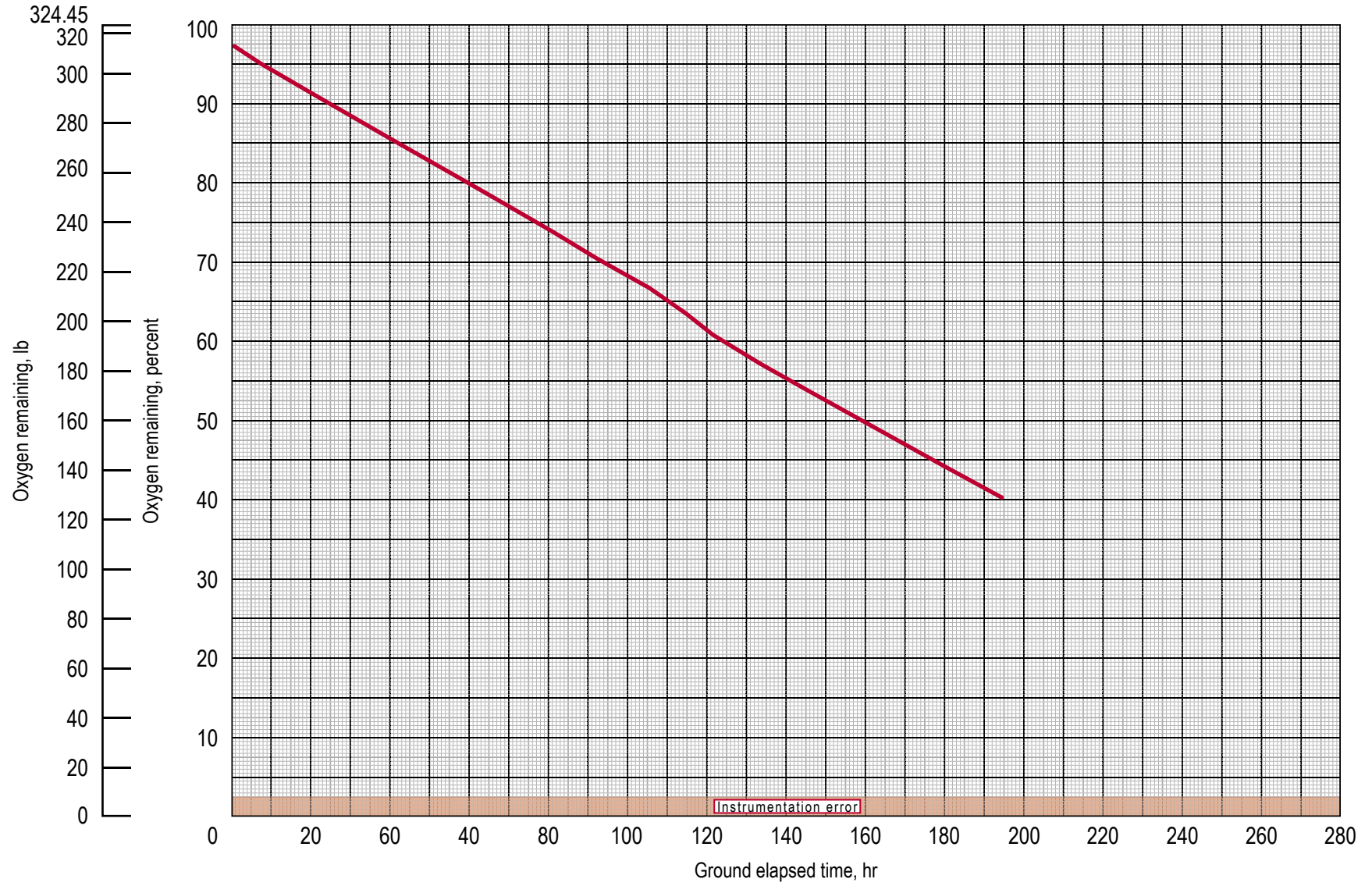

Figure 5-7  
Oxygen remaining for mission for one tank versus time

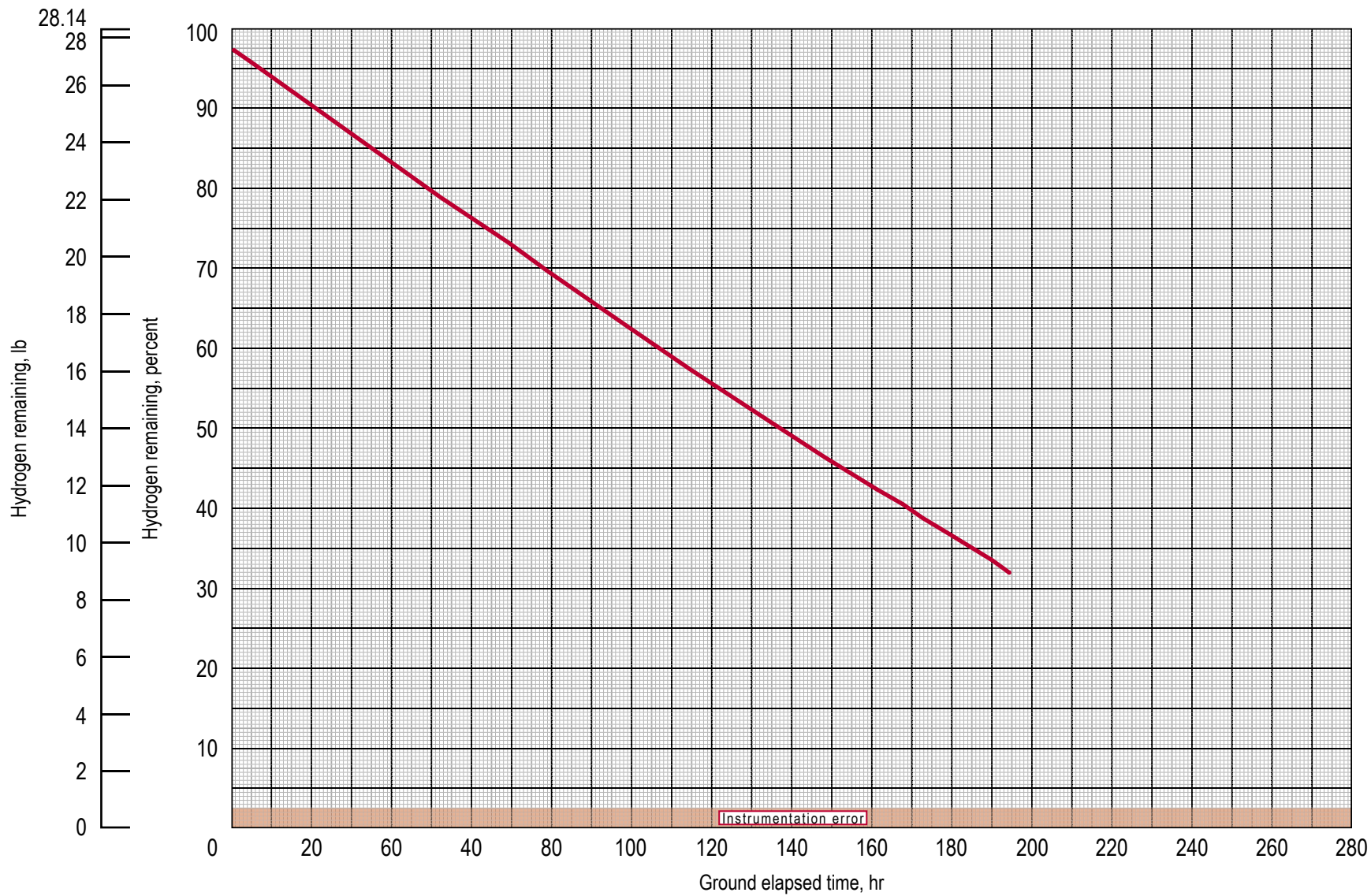

Figure 5-8  
Hydrogen remaining for mission for one tank versus time

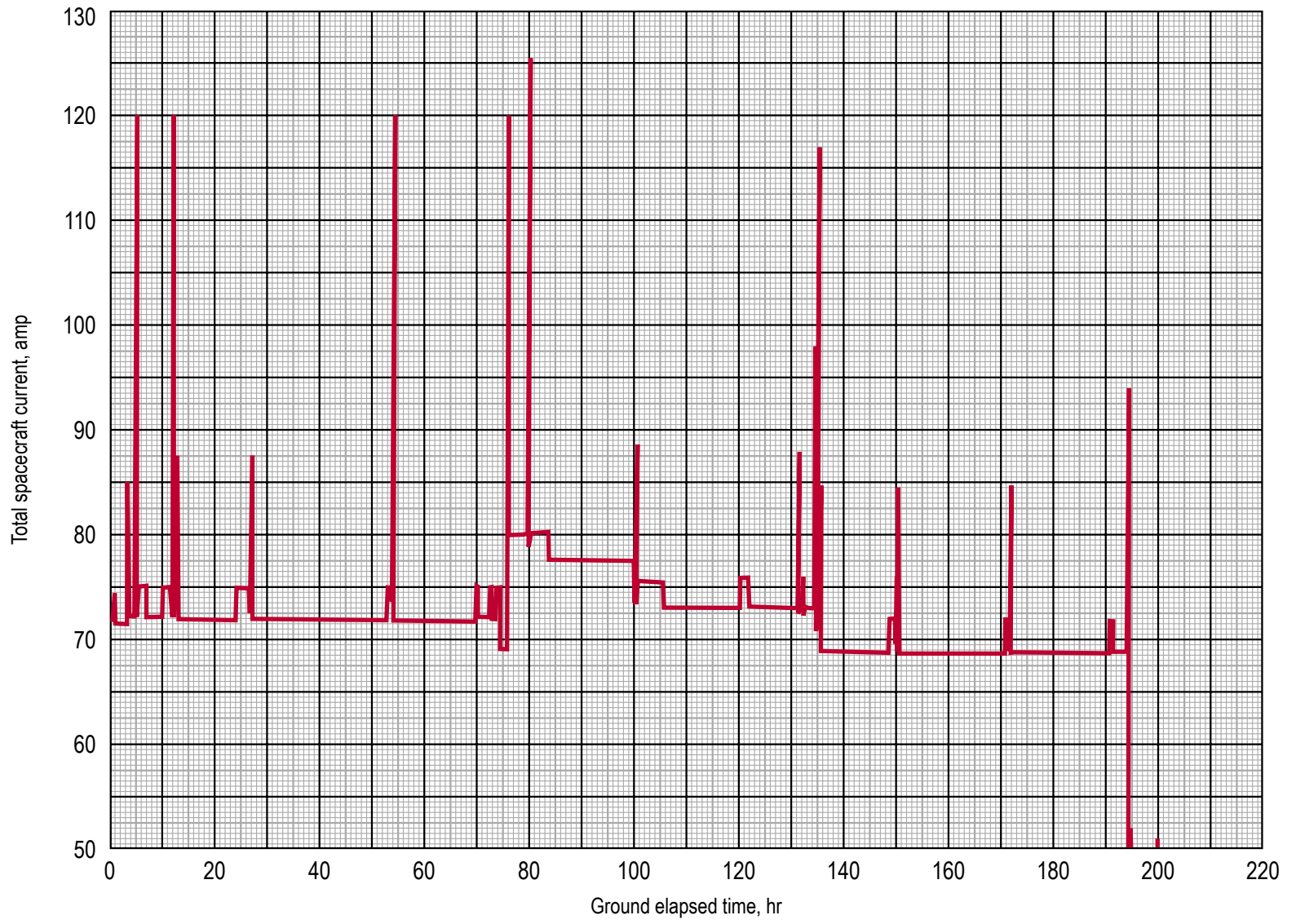

Figure 5-9  
CSM total spacecraft current profile

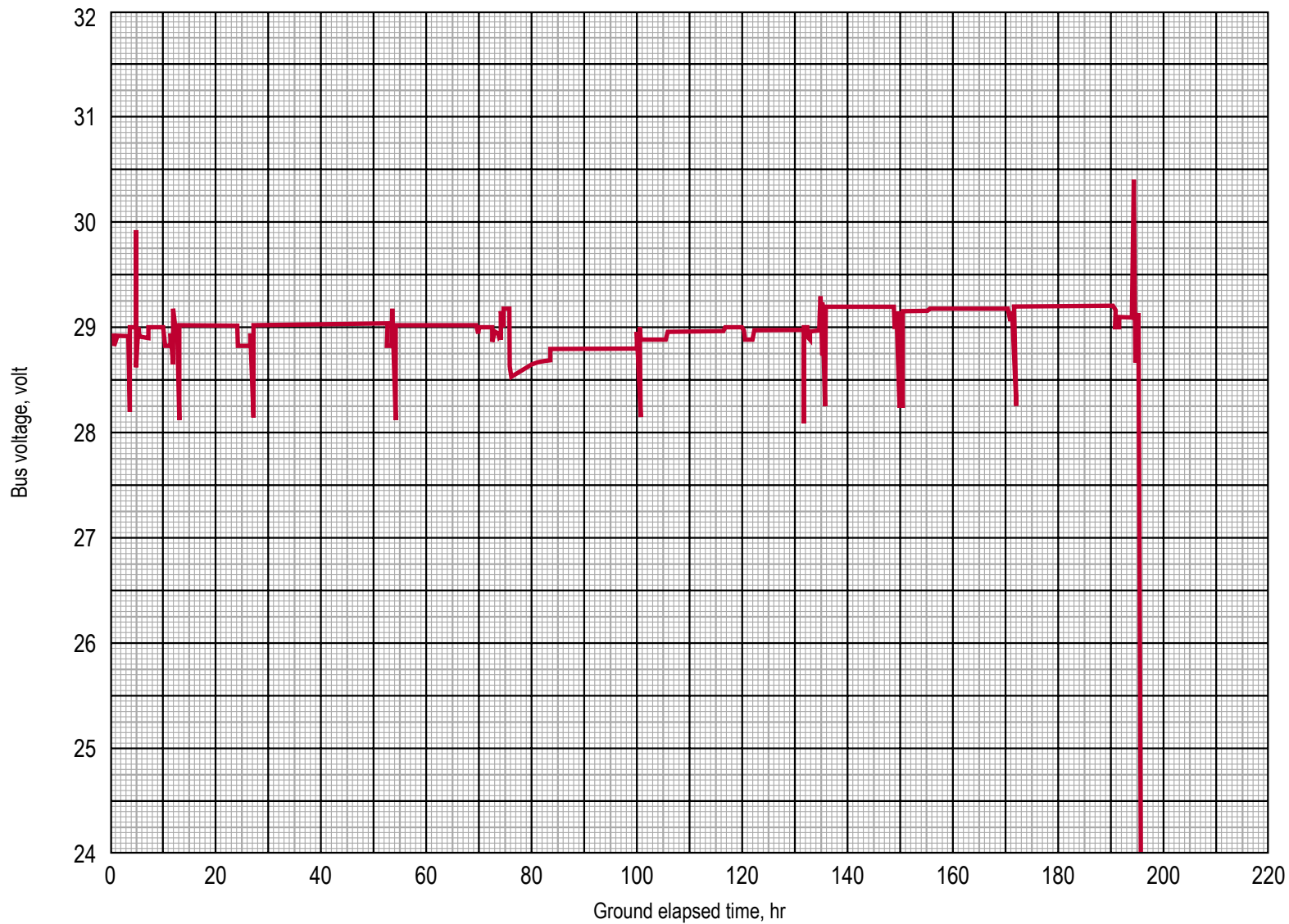

Figure 5-10  
CSM bus voltage versus time

## LM EPS ANALYSIS

### GROUND RULES AND ASSUMPTIONS

1. The descent stage batteries go on the line 30 minutes prior to earth liftoff.
2. A 3.8 hour checkout was assumed for lunar orbit.
3. Ascent and descent batteries were paralleled for the powered descent burn and prior to liftoff from the lunar surface.
4. The S-band equipment was assumed on 100 percent from initial activation in lunar orbit until completion of the mission.
5. The rendezvous radar electronics was assumed to be operational for the period of time dictated by the current G Mission flight plan.
6. The primary navigation and guidance subsystem (PGNCS) was left in the operate mode for the entire lunar stay.
7. The forward window heaters were left off for the entire mission.

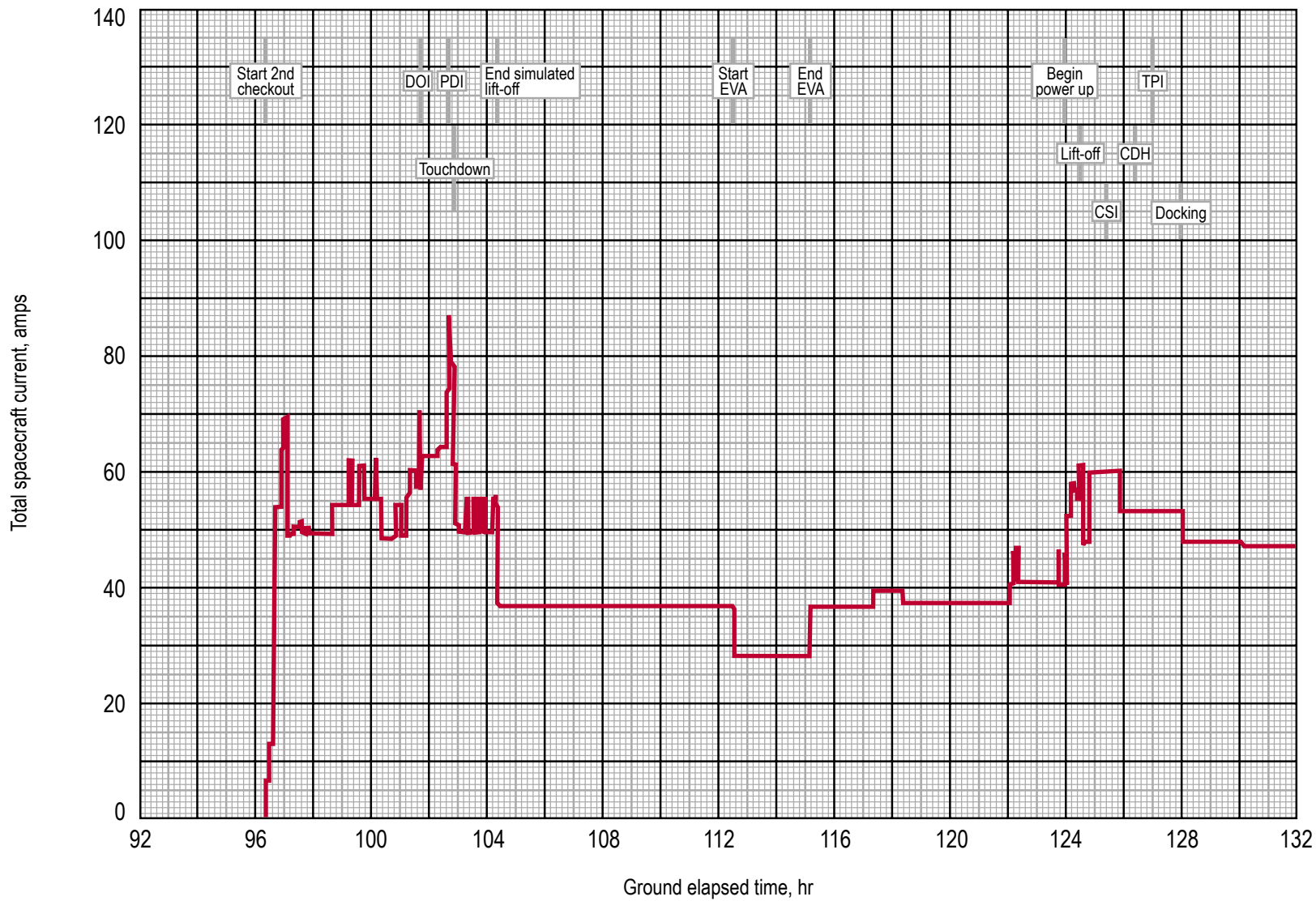

Figure 5-11  
LM-5 total spacecraft current

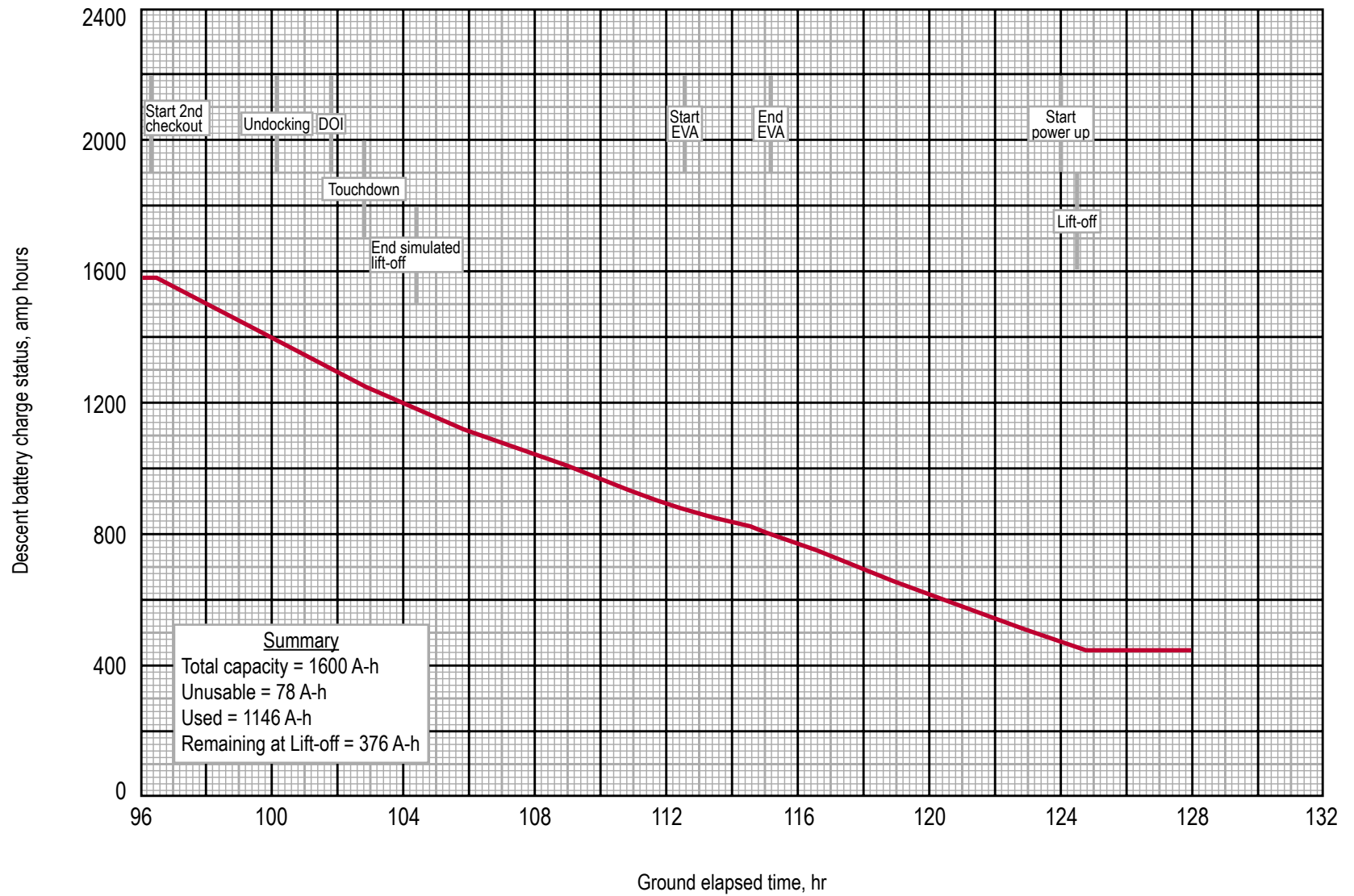

Figure 5-12  
Descent stage amp hours remaining



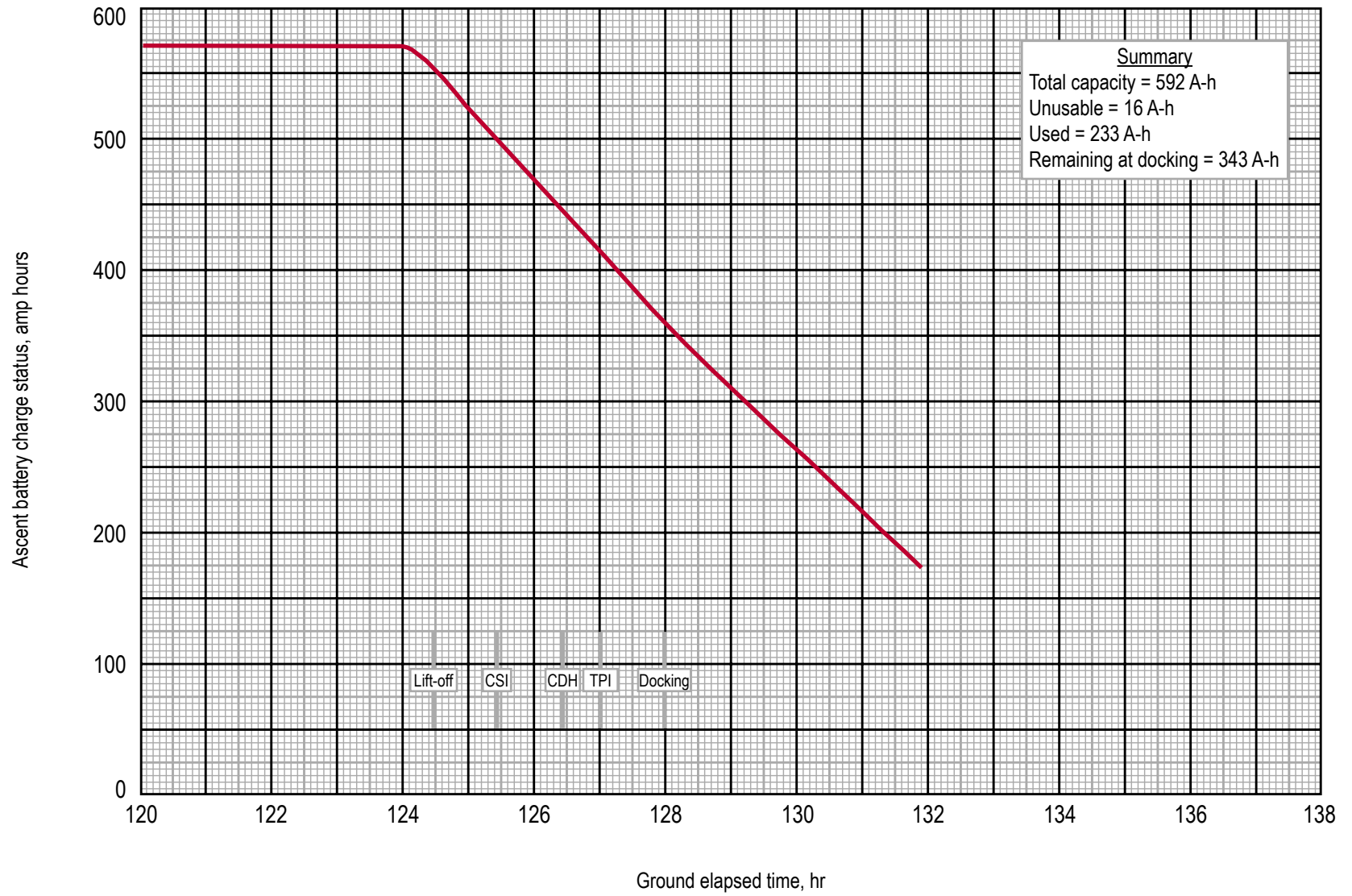

Figure 5-13  
Ascent stage amp hours remaining

LM ECS BUDGET

GROUND RULES AND ASSUMPTIONS

1. Cabin O<sub>2</sub> leakage rate was 0.2 lb/hr while pressurized
2. Metabolic rates were varied according to Volume 2 of the Spacecraft Operational Data Book
3. Metabolic O<sub>2</sub> consumed was  $(1.643 \times 10^{-4}) \times (\text{metabolic rate})$
4. LM pressurization requires 6.62 lb of O<sub>2</sub>
5. Cabin pressure regulator check requires 2.65 lb of O<sub>2</sub>
6. H<sub>2</sub>O consumed because of sublimator cooling was total heat removed divided by 1040 (btu per lb) of H<sub>2</sub>O
7. H<sub>2</sub>O lost due to urination was 0.11 lb/hr per man
8. Cabin temperature control was set to 72° F
9. Average glycol flow rate was 250 lb/hr
10. Budget was performed on the operational trajectory and may change when the revision 1 is analyzed.

TABLE 5-13  
LM ECS Summary

(a) Descent Stage

<u>Description</u>	<u>O<sub>2</sub>, lb</u>	<u>H<sub>2</sub>O, lb</u>
Loaded	48.00	210.6
Unusable	3.40	16.4
Available for mission	44.60	194.2
Required for mission	26.17	142.4
Usable remaining in tanks	18.43	51.8

(b) Ascent Stage

Loaded	4.86	85.00
Unusable	.74	4.20
Available for mission	4.12	80.80
Required for mission	1.95	45.48
Usable remaining in tanks	2.17	35.32

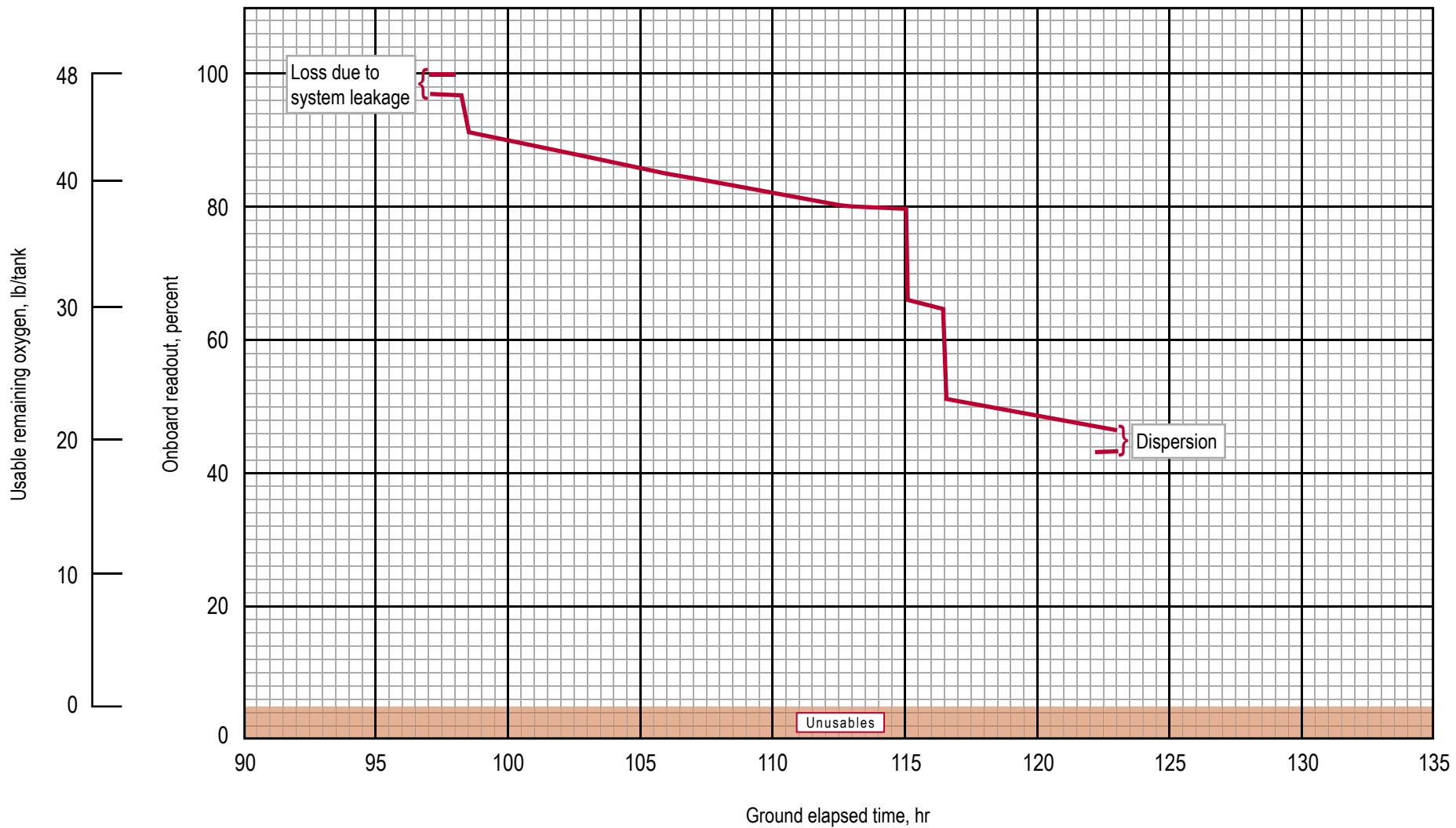

Figure 5-14  
Descent oxygen tank quantities as a function of mission time

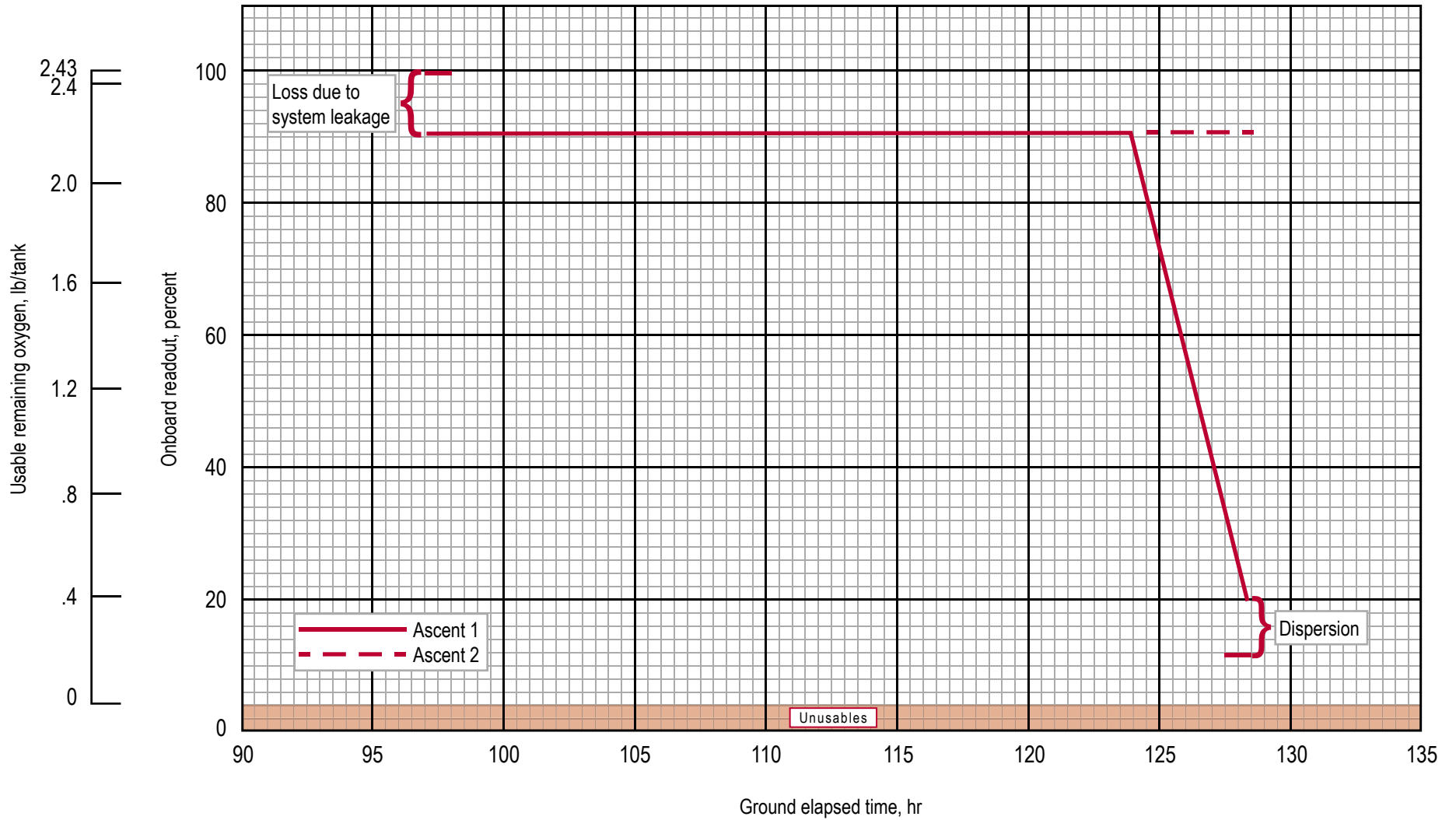

Figure 5-15  
Ascent oxygen tank quantities as a function of mission time

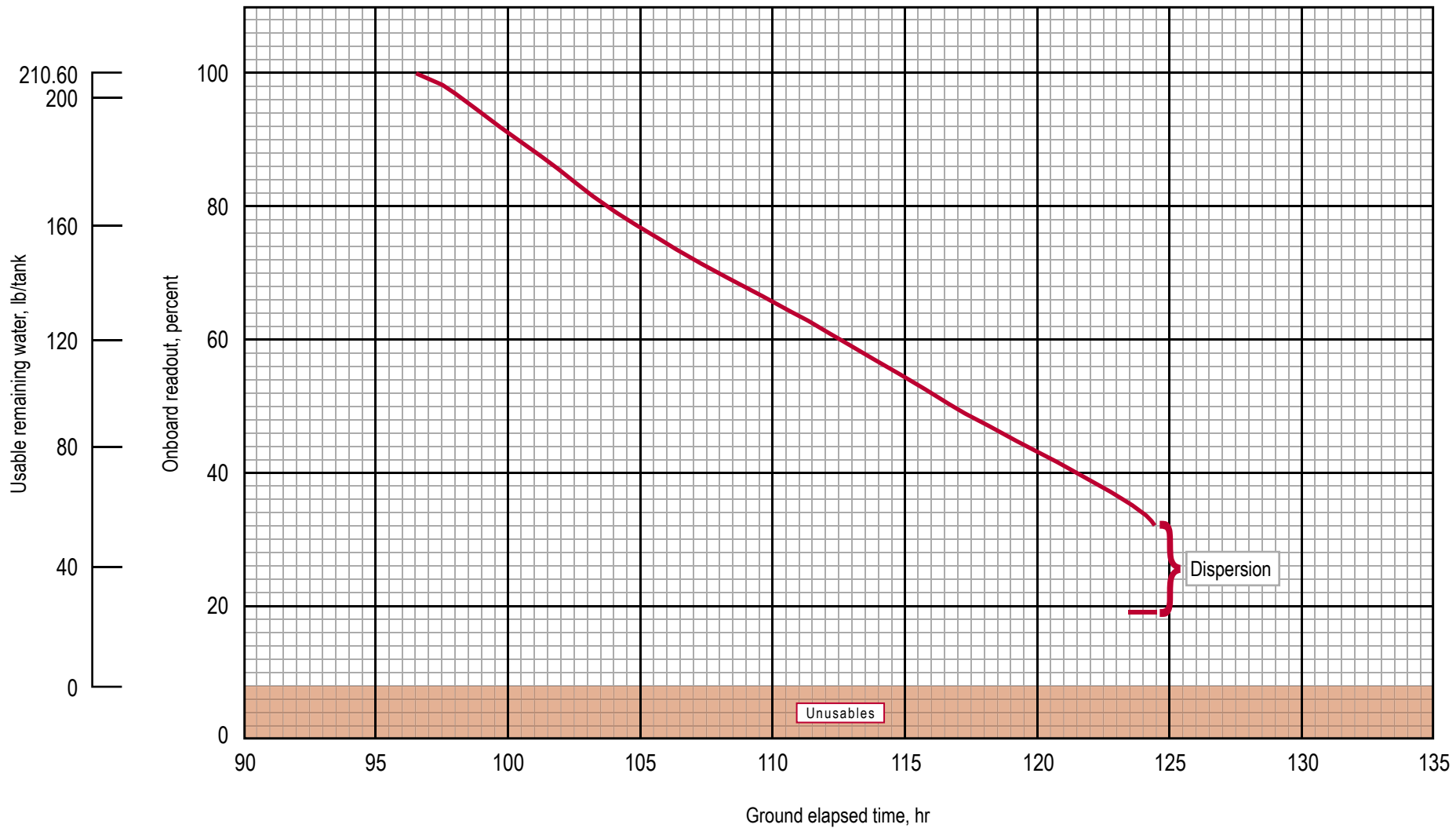

Figure 5-16  
Descent water tank quantities as a function of mission time

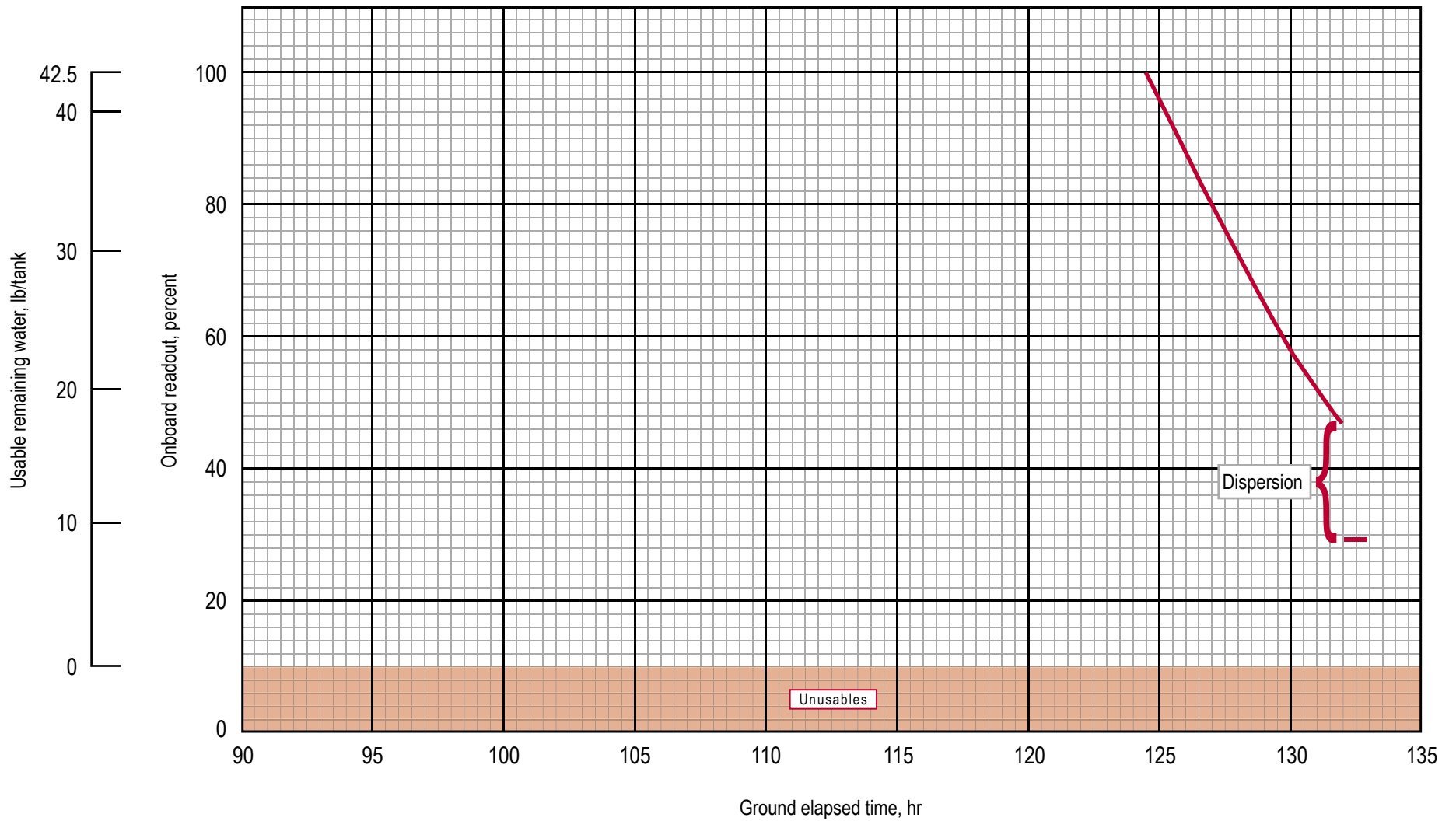

Figure 5-17  
Ascent water tank quantities as a function of mission time

MISSION G PLSS CONSUMABLE ANALYSIS

THE RESULTS OF THE PLSS BATTERY, OXYGEN, WATER AND LiOH CONSUMABLE ANALYSIS ARE SUMMARIZED IN THE FOLLOWING FIGURES:

FIGURE5-18	LMP AND CDR PLSS BATTERY PROFILE
FIGURE5-19	CDR OXYGEN PROFILE
FIGURE5-20	LMP OXYGEN PROFILE
FIGURE5-21	CDR H2O PROFILE
FIGURE5-22	LMP H2O PROFILE
FIGURE5-23	LMP AND CDR LiOH CO2 PROFILE

# NOMINAL LUNAR SURFACE EVA

FIGURE 5-18 LMP AND CDR - PLSS BATTERY

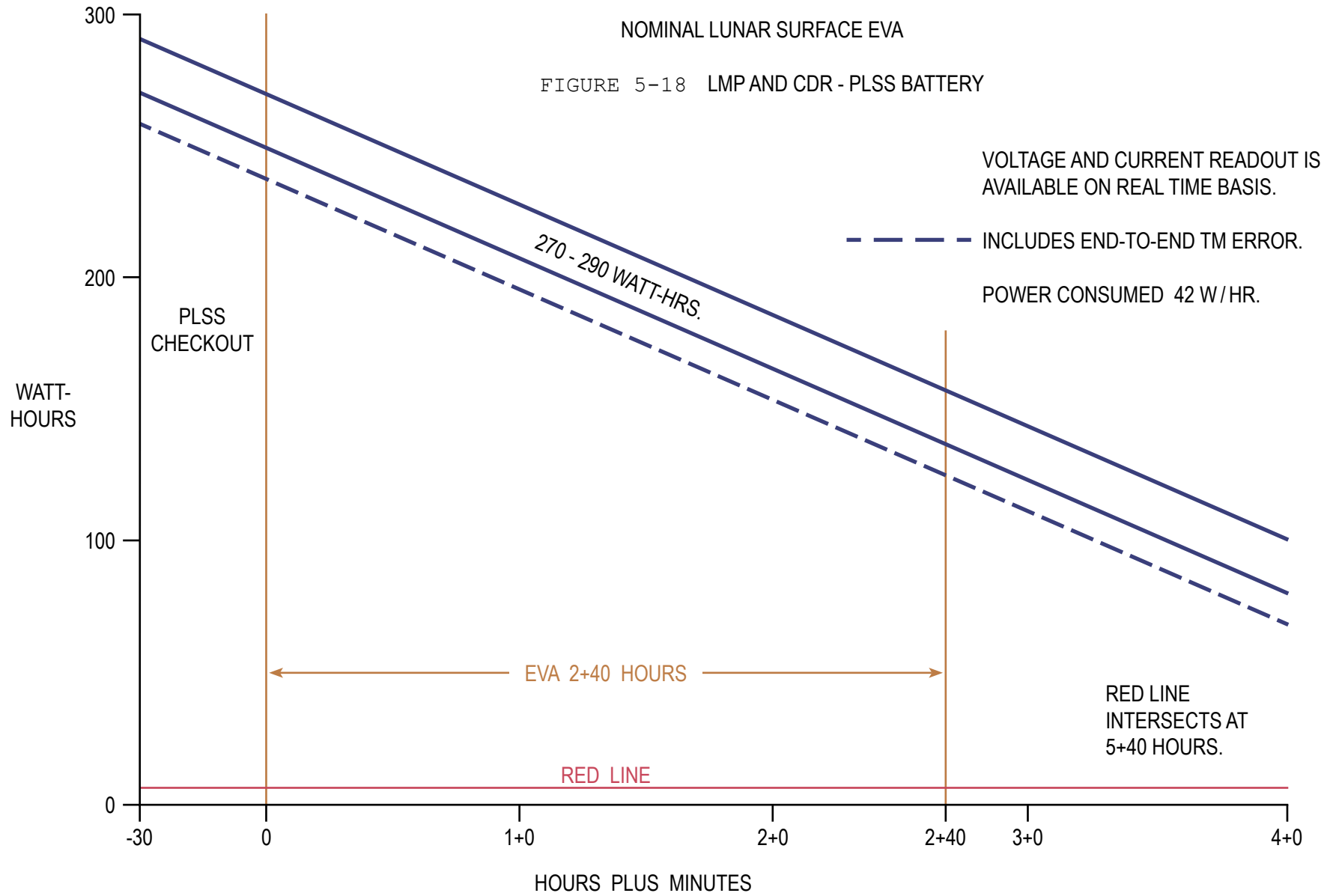



# NOMINAL LUNAR SURFACE EVA

FIGURE 5-19 CDR - OXYGEN

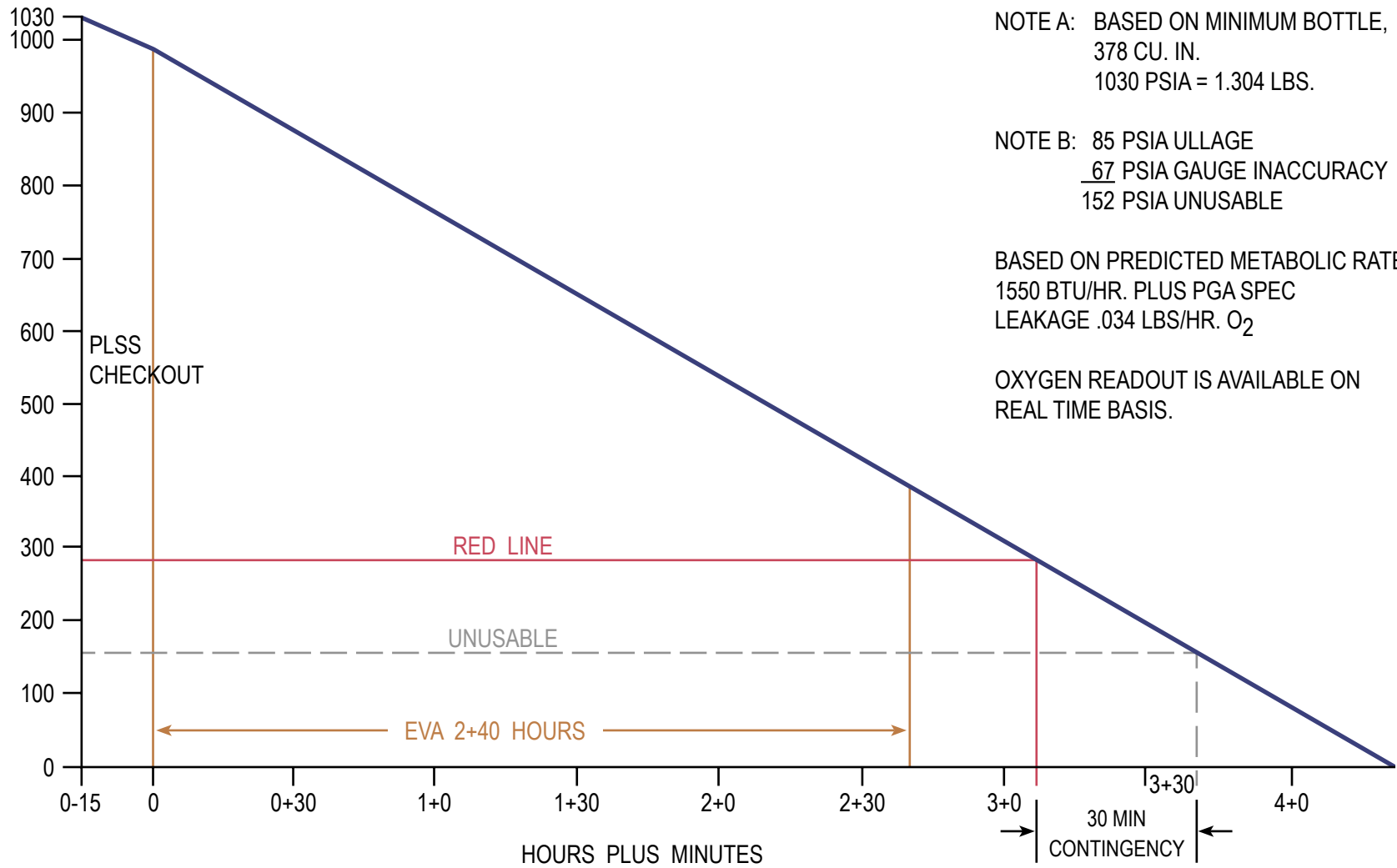

NOTE A: BASED ON MINIMUM BOTTLE,  
378 CU. IN.  
1030 PSIA = 1.304 LBS.

NOTE B: 85 PSIA ULLAGE  
67 PSIA GAUGE INACCURACY  
152 PSIA UNUSABLE

BASED ON PREDICTED METABOLIC RATE  
1550 BTU/HR. PLUS PGA SPEC  
LEAKAGE .034 LBS/HR. O<sub>2</sub>

OXYGEN READOUT IS AVAILABLE ON  
REAL TIME BASIS.

# NOMINAL LUNAR SURFACE EVA

FIGURE 5-20 LMP - OXYGEN

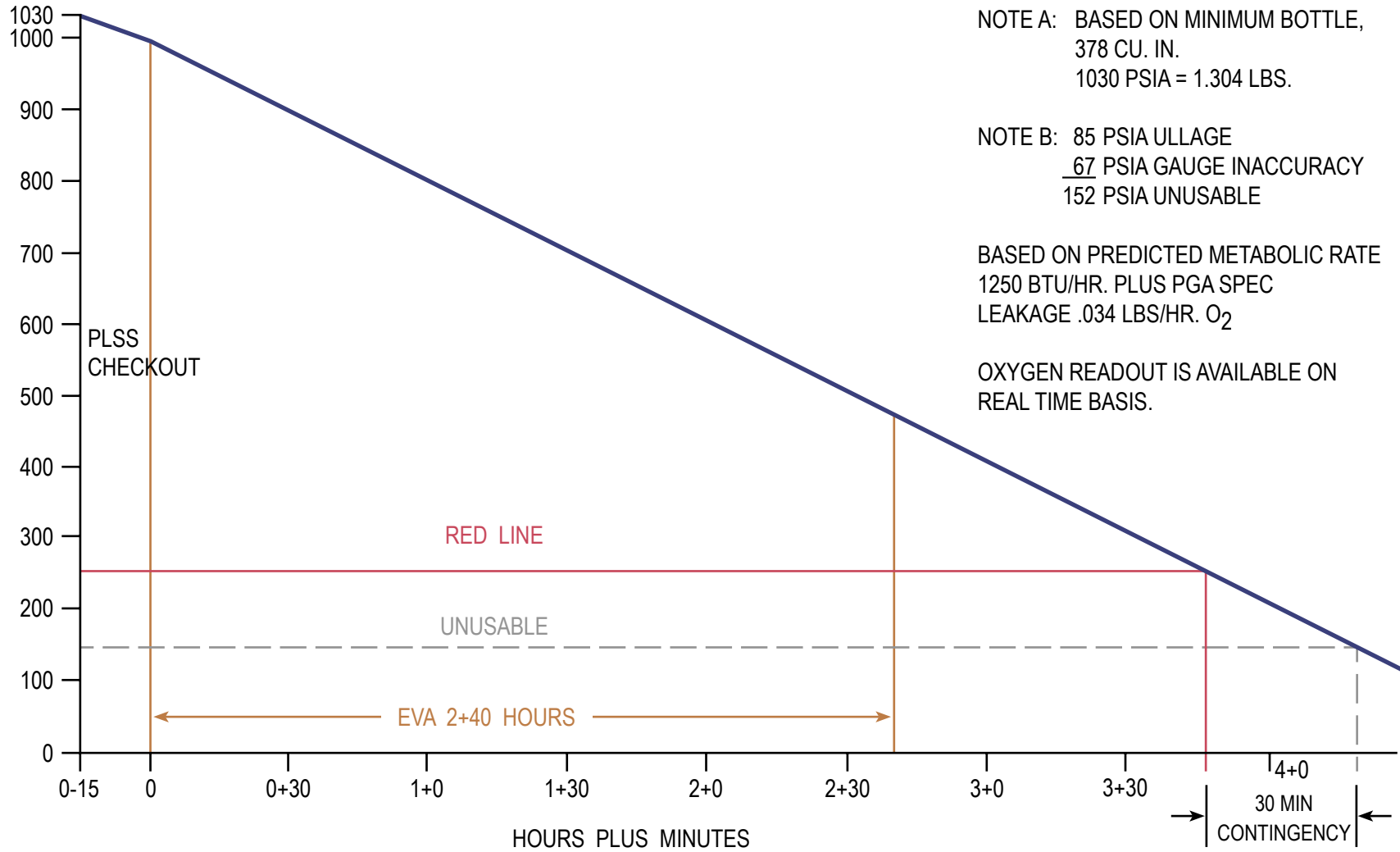

NOTE A: BASED ON MINIMUM BOTTLE,  
378 CU. IN.  
1030 PSIA = 1.304 LBS.

NOTE B: 85 PSIA ULLAGE  
67 PSIA GAUGE INACCURACY  
152 PSIA UNUSABLE

BASED ON PREDICTED METABOLIC RATE  
1250 BTU/HR. PLUS PGA SPEC  
LEAKAGE .034 LBS/HR. O<sub>2</sub>

OXYGEN READOUT IS AVAILABLE ON  
REAL TIME BASIS.

NOMINAL LUNAR SURFACE EVA

FIGURE 5-21 CDR - WATER

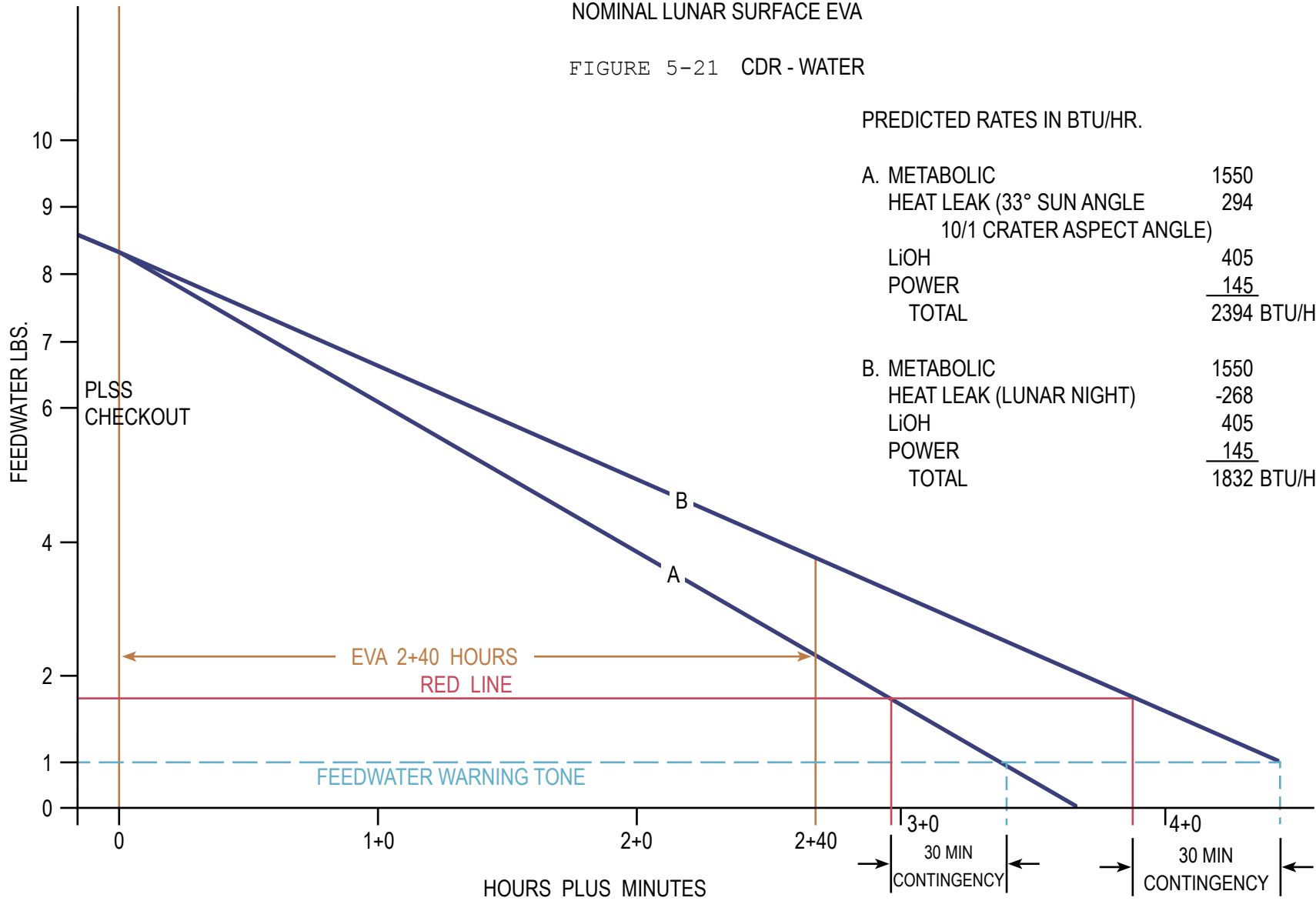

NOMINAL LUNAR SURFACE EVA

FIGURE 5-22 LMP - WATER

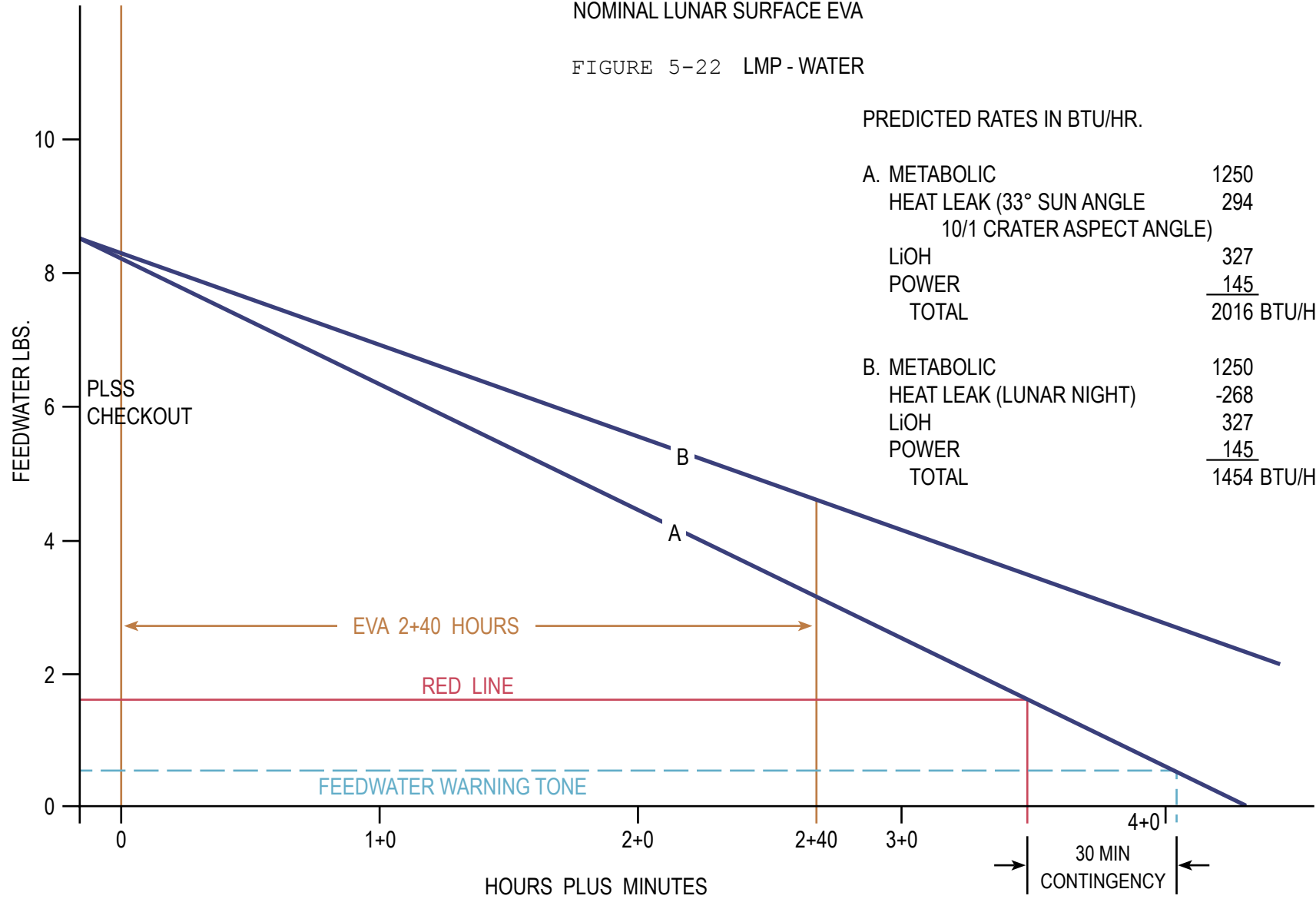

### NOMINAL LUNAR SURFACE EVA

FIGURE 5-23 LMP & CDR LiOH

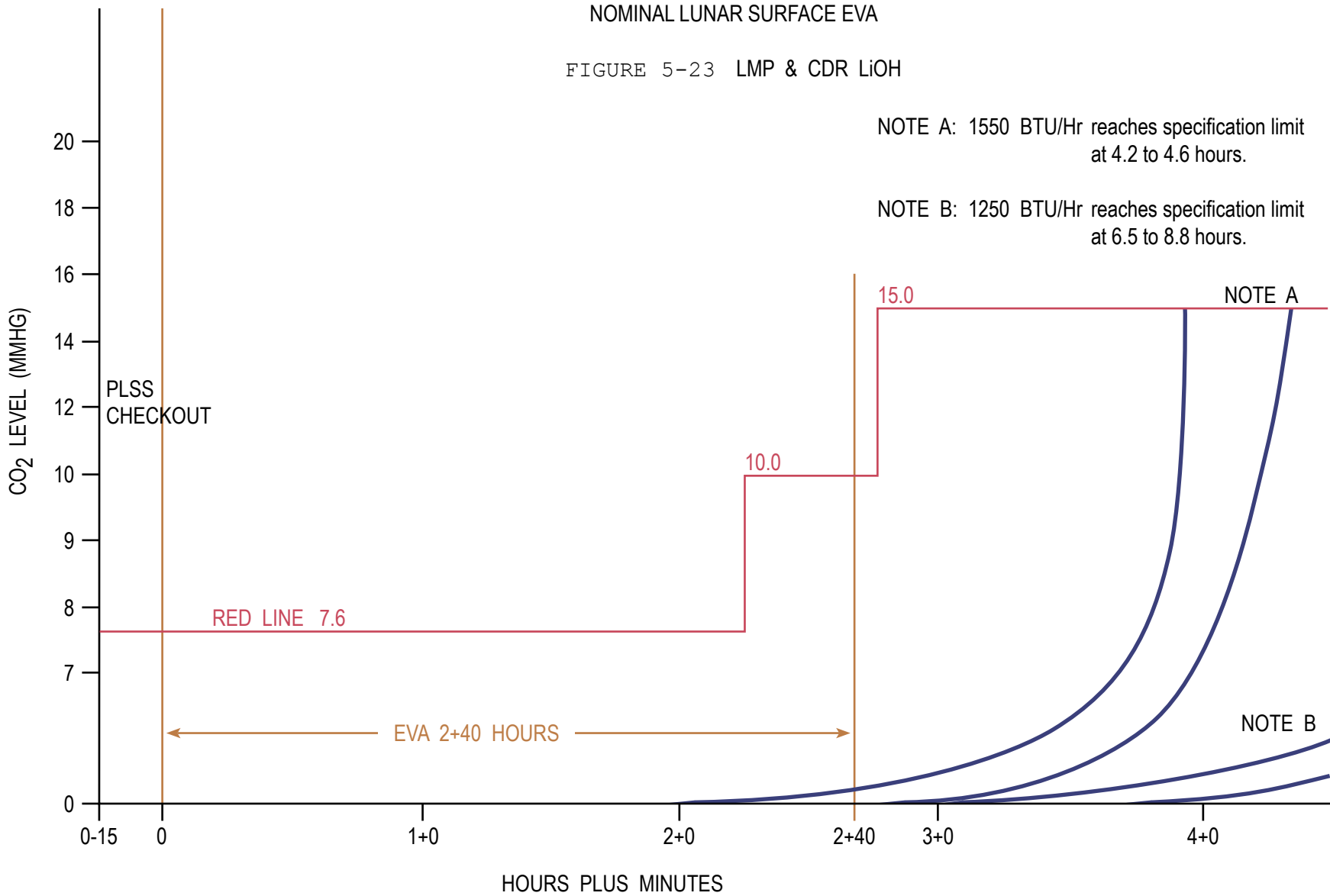

NOTE A: 1550 BTU/Hr reaches specification limit at 4.2 to 4.6 hours.

NOTE B: 1250 BTU/Hr reaches specification limit at 6.5 to 8.8 hours.

15.0 NOTE A

10.0

RED LINE 7.6

EVA 2+40 HOURS

NOTE B

CO<sub>2</sub> LEVEL (MMHG)

HOURS PLUS MINUTES

20  
18  
16  
14  
12  
10  
9  
8  
7  
0

0-15 0 1+0 2+0 2+40 3+0 4+0

THIS PAGE INTENTIONALLY LEFT BLANK.

SECTION VI

**SUMMARY FLIGHT PLAN**





# FLIGHT PLAN

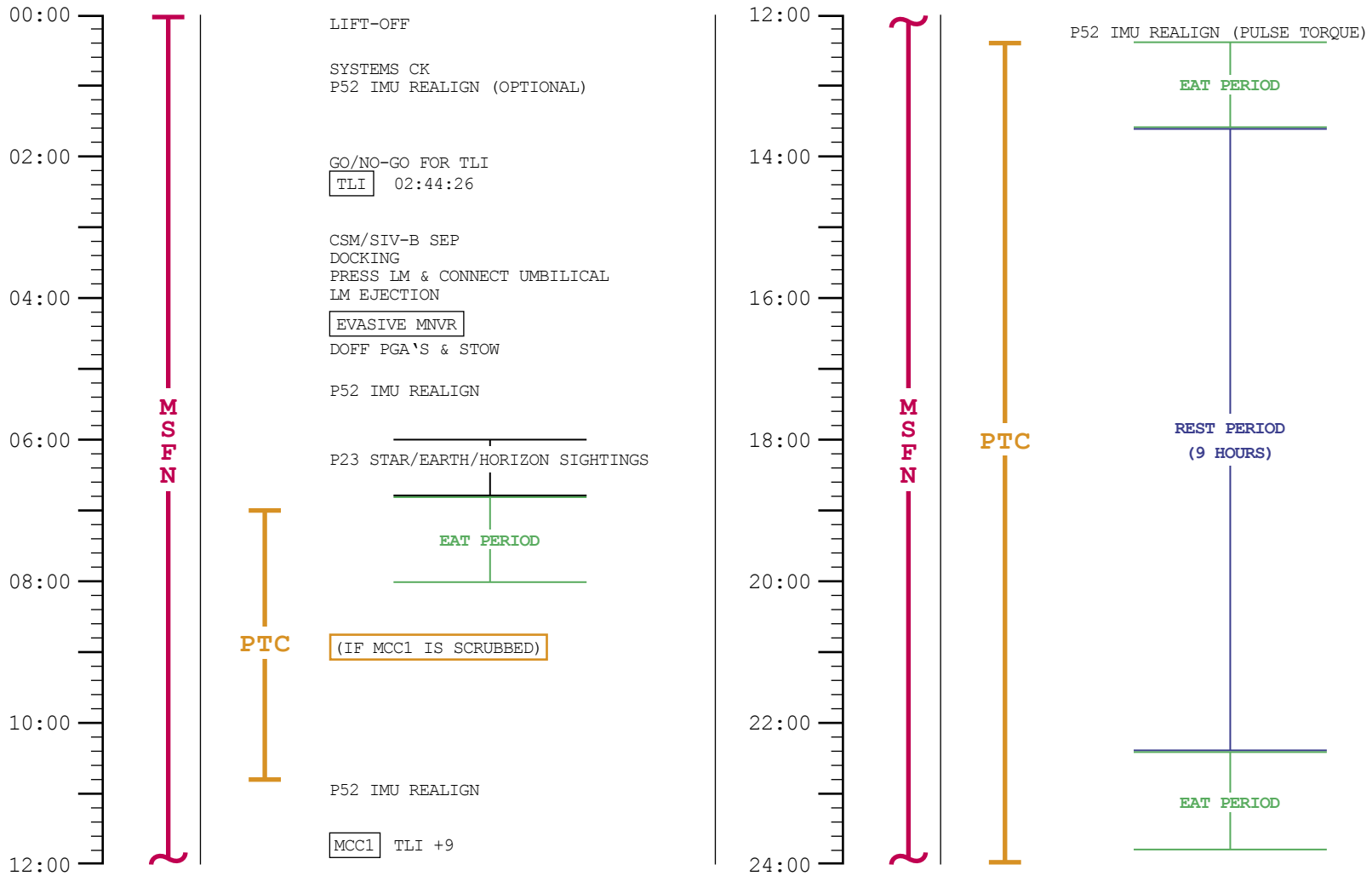

MISSION	EDITION	DATE	TIME	DAY / REV	PAGE
APOLLO 11	FINAL	JULY 1, 1969	00:00 - 24:00	1 / TLC	6-1

# FLIGHT PLAN

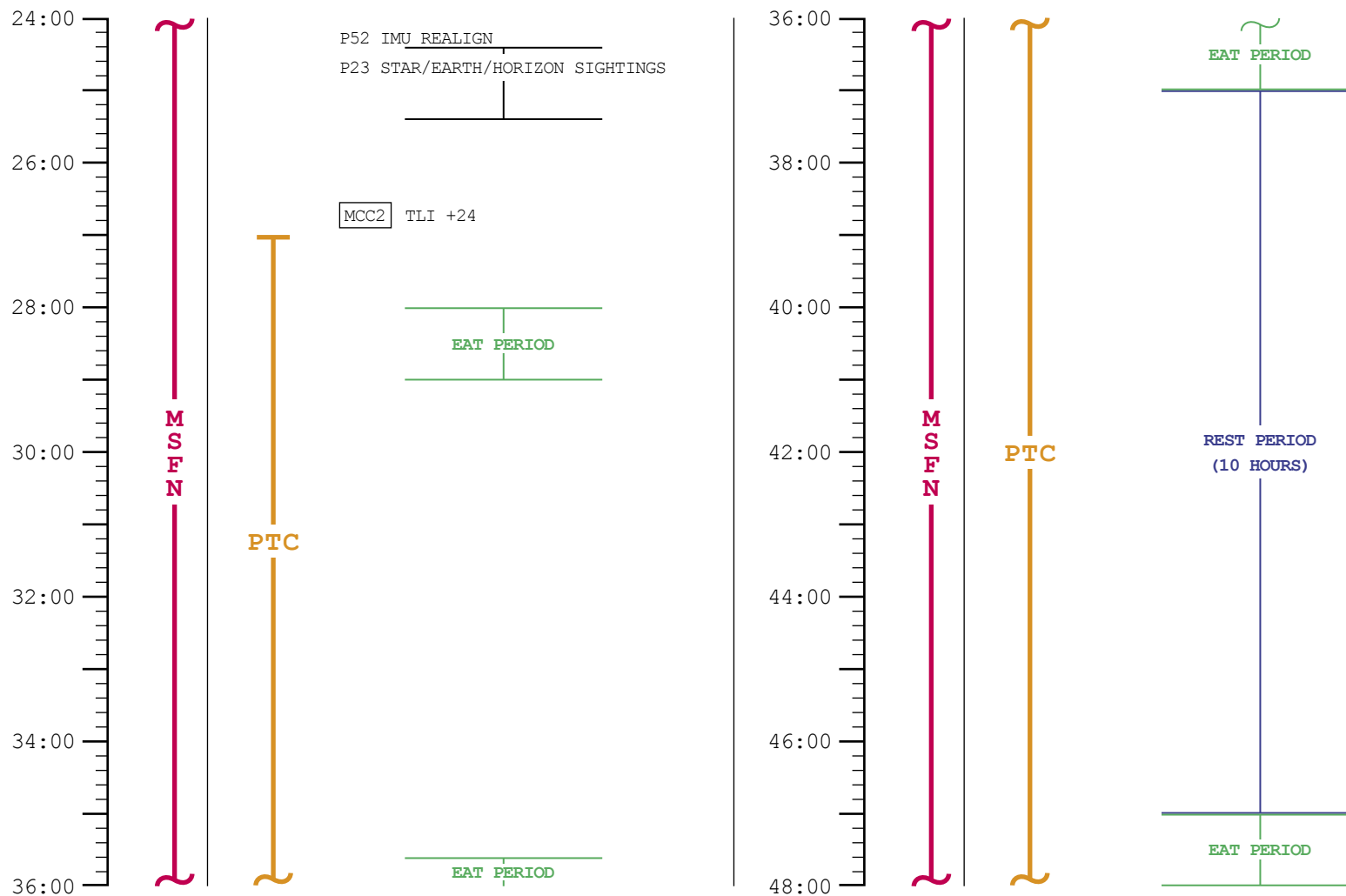

MISSION	EDITION	DATE	TIME	DAY / REV	PAGE
APOLLO 11	FINAL	JULY 1, 1969	24:00 - 48:00	2 / TLC	6-2

# FLIGHT PLAN

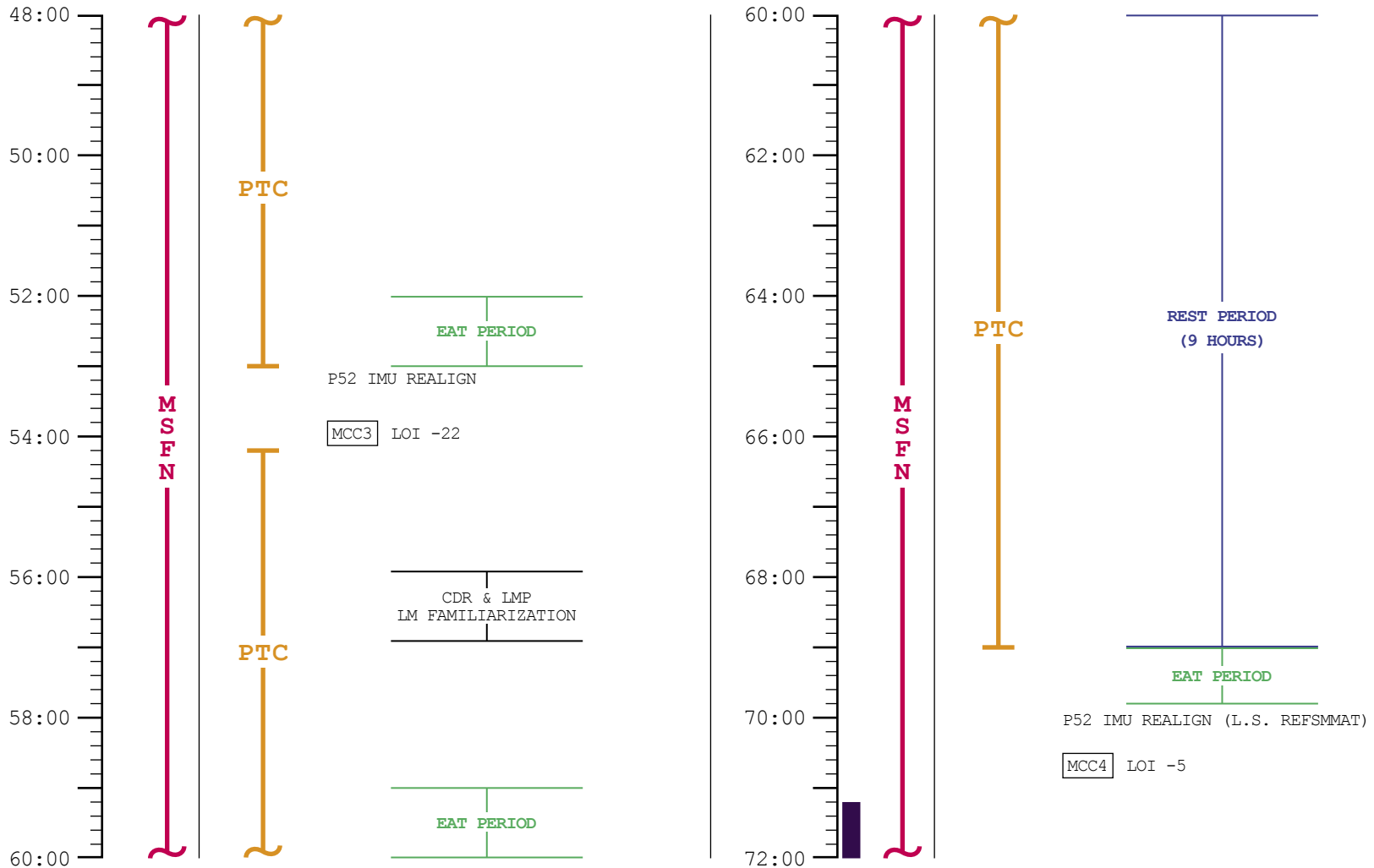

MISSION	EDITION	DATE	TIME	DAY / REV	PAGE
APOLLO 11	FINAL	JULY 1, 1969	48:00 - 72:00	3 / TLC	6-3

# FLIGHT PLAN

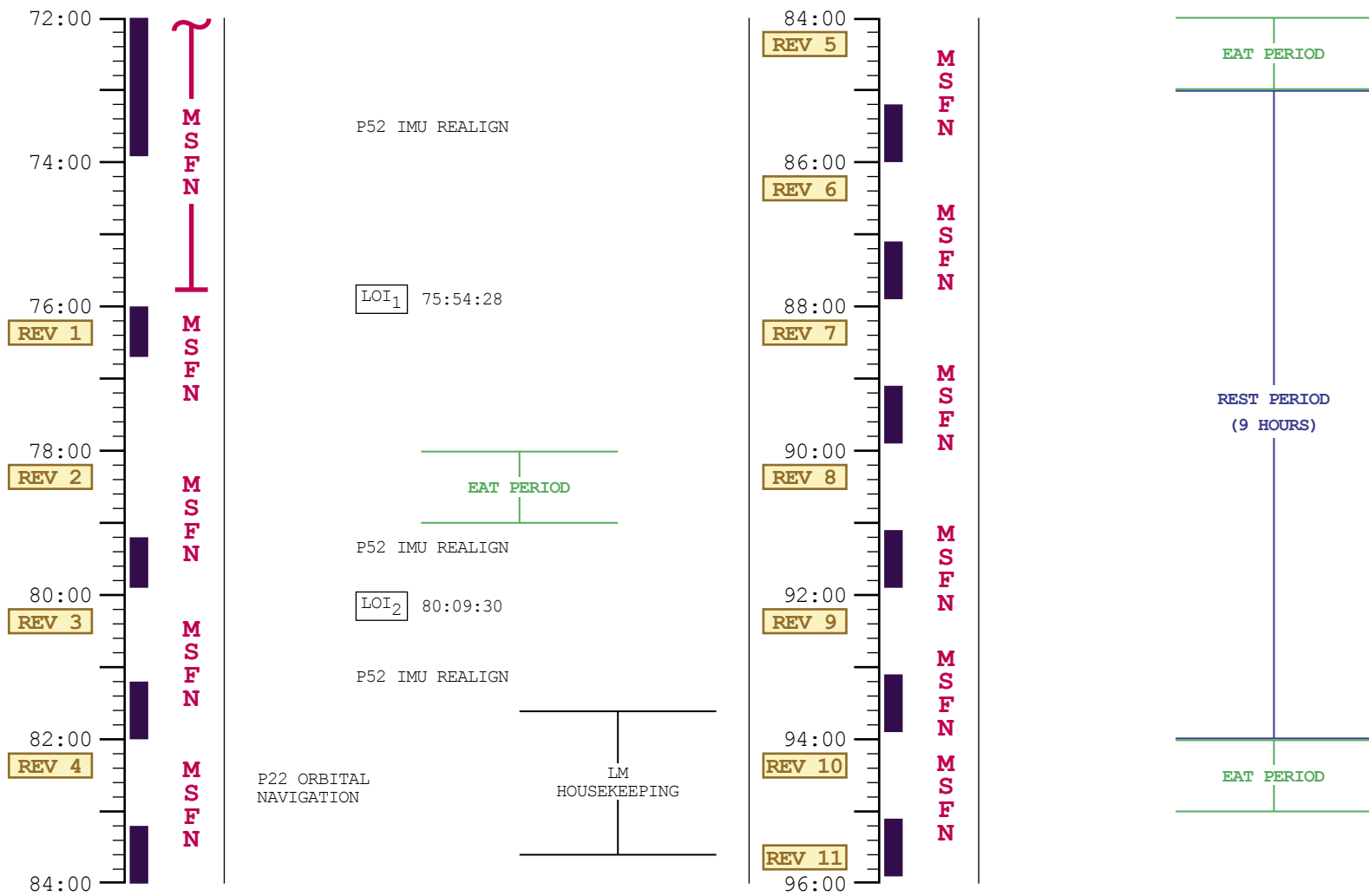

MISSION	EDITION	DATE	TIME	DAY / REV	PAGE
APOLLO 11	FINAL	JULY 1, 1969	72:00 - 96:00	4 / 1 THRU 10	6-4

# FLIGHT PLAN

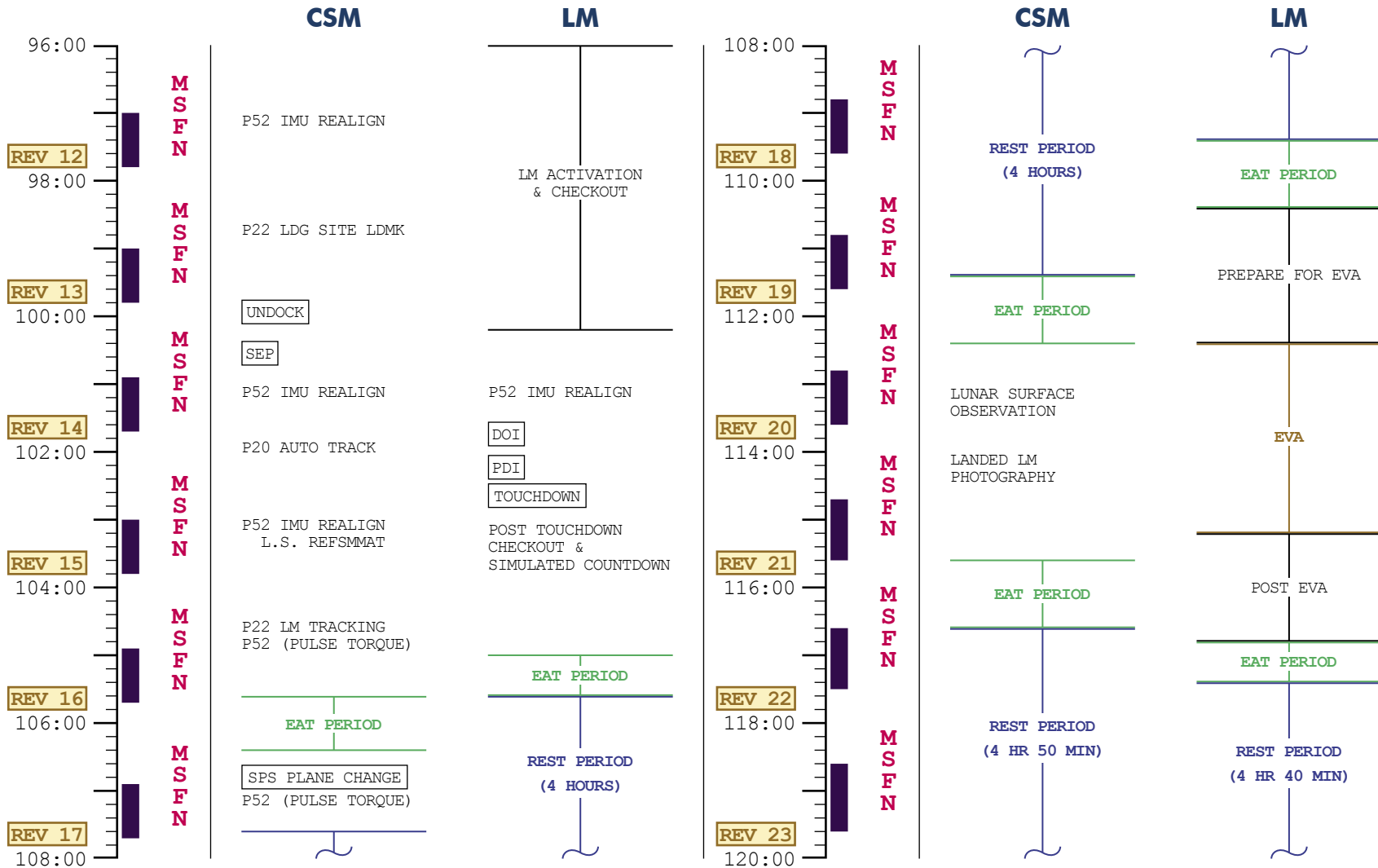

MISSION	EDITION	DATE	TIME	DAY / REV	PAGE
APOLLO 11	FINAL	JULY 1, 1969	96:00 - 120:00	5 / LPO	6-5

# FLIGHT PLAN

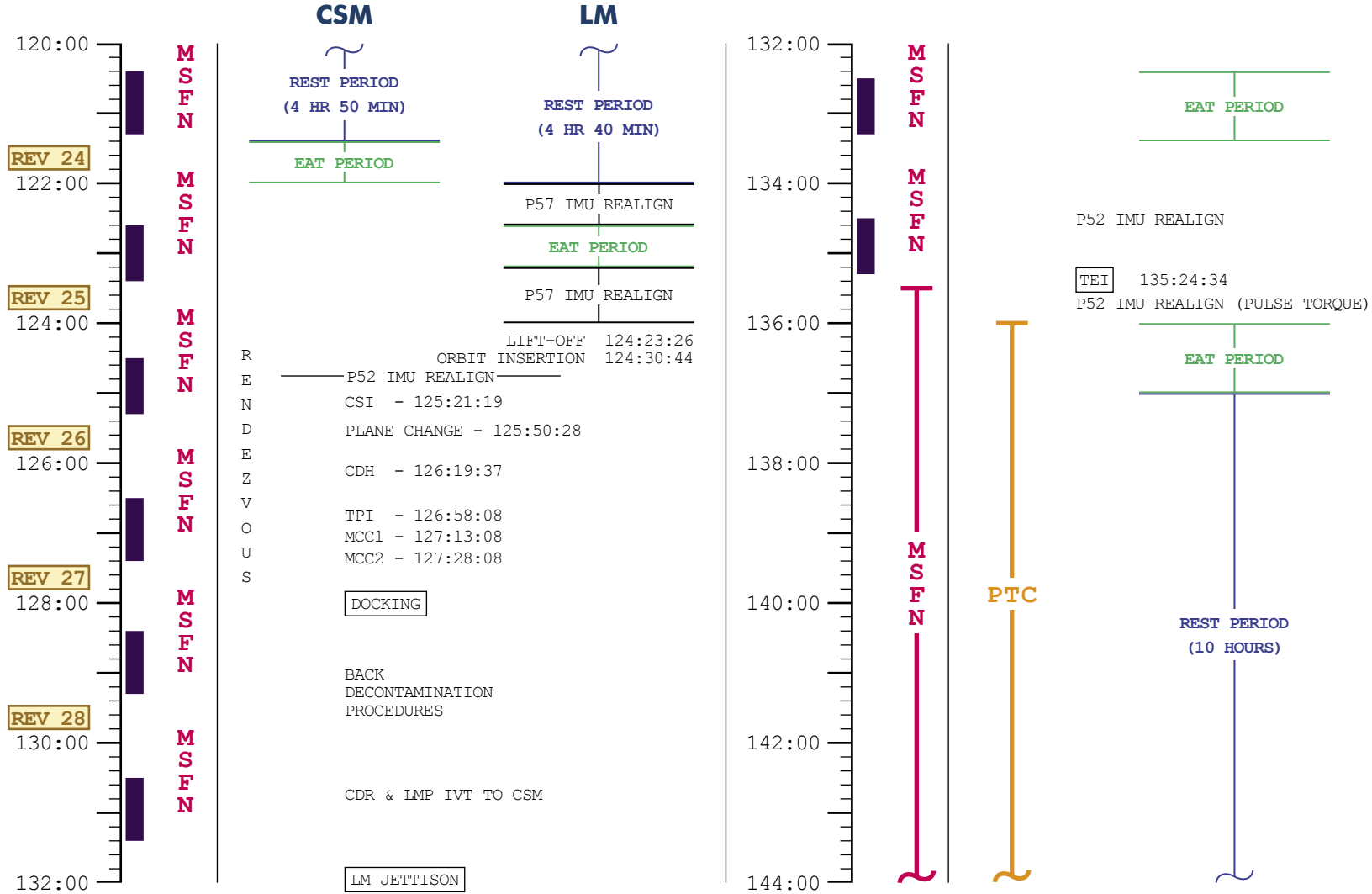

MISSION	EDITION	DATE	TIME	DAY / REV	PAGE
APOLLO 11	FINAL	JULY 1, 1969	120:00 - 144:00	6 / LPO	6-6

# FLIGHT PLAN

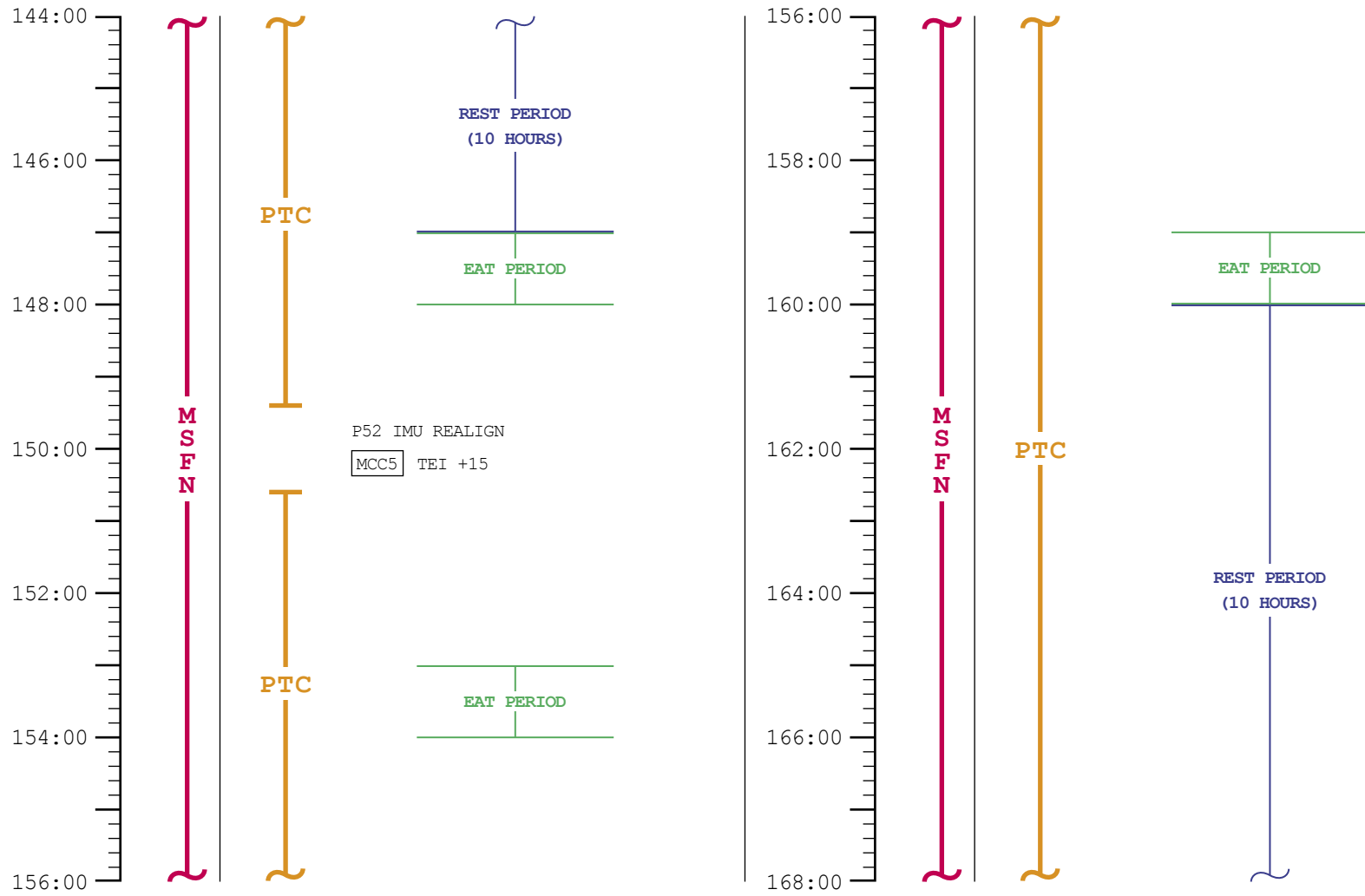

MISSION	EDITION	DATE	TIME	DAY / REV	PAGE
APOLLO 11	FINAL	JULY 1, 1969	144:00 - 168:00	7 / TEC	6-7

# FLIGHT PLAN

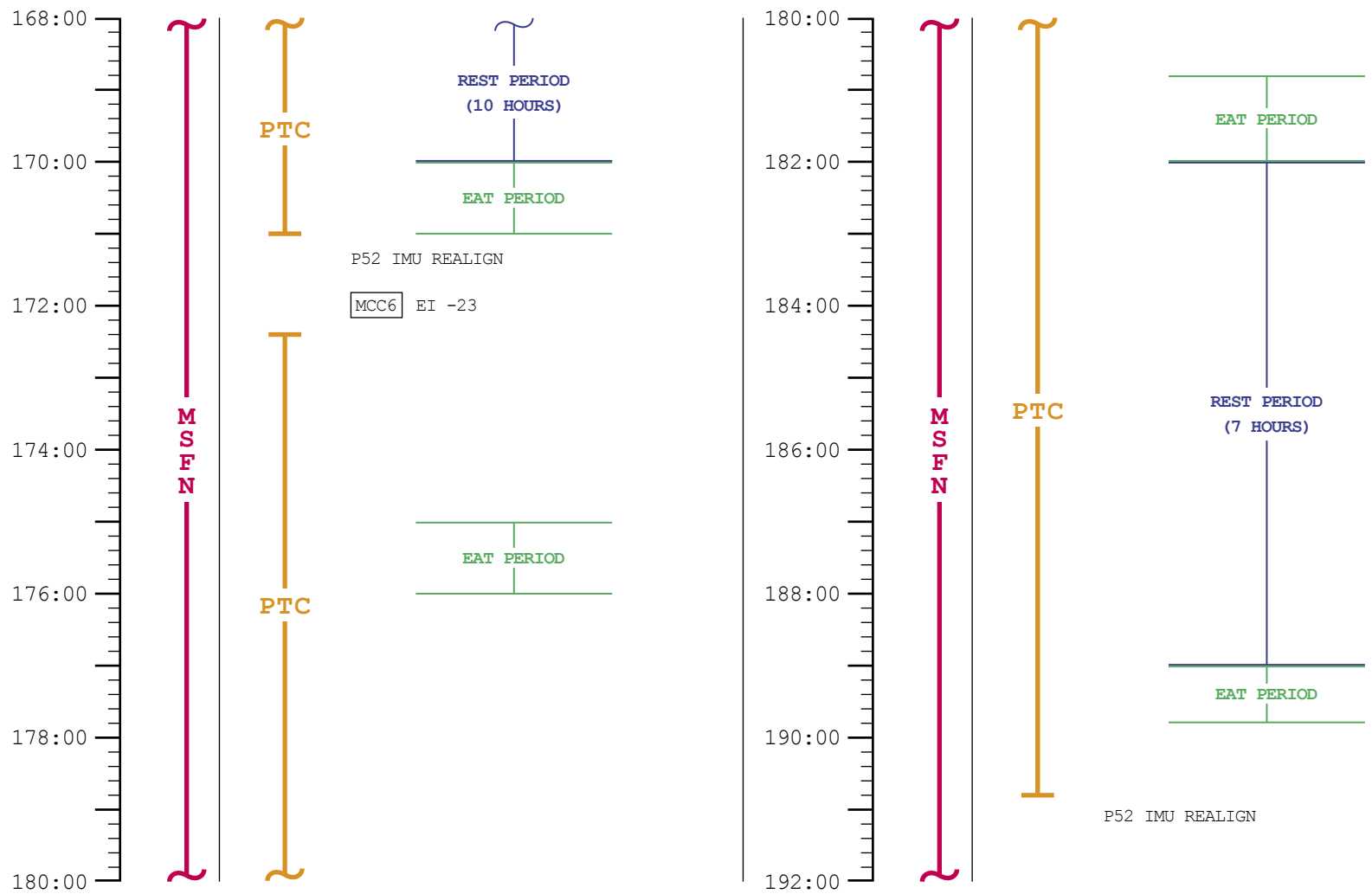



# FLIGHT PLAN

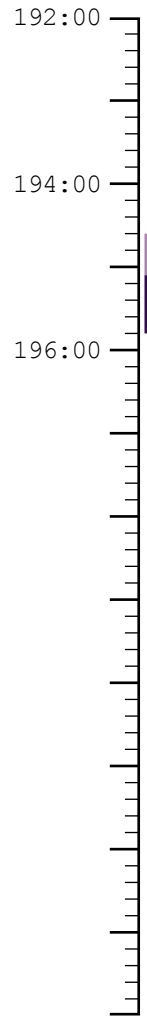

MCC7 EI -3

P52 IMU REALIGN

CM/SM SEP

EI 195:03:27

LANDING

MISSION	EDITION	DATE	TIME	DAY / REV	PAGE
APOLLO 11	FINAL	JULY 1, 1969	192:00 - 196:00	9	6-9